

A NOTE FROM TARA WEST

This is a comprehensive and phonics-based set of encoding free downloads including instructional cards and printables. Choose from a variety of resources to implement into your phonics lessons, small-group lessons, writing lessons, or as an independent phonics center. This free download includes (5) encoding resources. If you have questions about this packet, reach out to me directly at littlemindsatworkLLC@gmail.com
Word lists found at the back of this download.

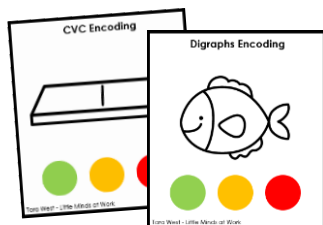

Freebie #1



Each card displays the phonics skill, includes an image, and has color-coded dots indicating sounds: green for the beginning sound, yellow for the medial sound, and red for the final sound. These cards are useful for practicing word segmentation and spelling in both whole-group and small-group settings.

Freebie #2

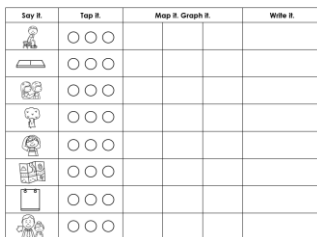

These sheets offer all-in-one resource for paper-and-pencil encoding. Students will say the word, tap out the sounds, map the sounds, write the graphemes in each box, and then spell the word. These worksheets are versatile and can be used in whole-group instruction, small-group activities, or as an independent center.

Freebie #3

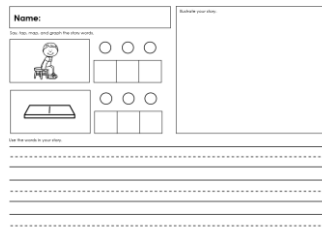

These sheets provide a differentiated approach to integrating encoding and writing skills. Students will say the words, tap the sounds, map the sounds, and write the words. They will then use these words to create a story and illustrate it with a picture. These worksheets can be used in whole-group or as a learning center.

Freebie #4

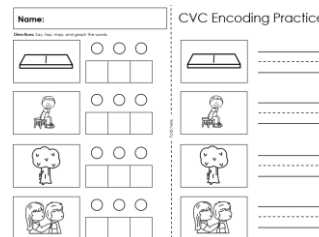

These sheets offer an interactive and engaging method for practicing encoding. The activity begins with the paper folded. Students will say the word, tap and map the sounds, then flip the folded page to write each word. These sheets are perfect for whole-group or as a phonics center.

Freebie #5

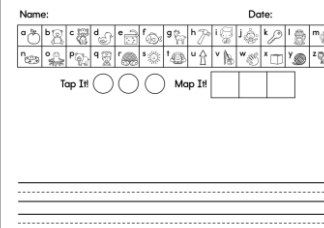

These open-ended sheets are designed to support writing through interactive phonics practice. Built-in dots allow students to tap out the sounds in a word, while sound boxes enable them to map the sounds using manipulatives. Both the dots and sound boxes can be utilized throughout their writing for immediate and meaningful application.

CVC Encoding



Tara West - Little Minds at Work

CVC Encoding

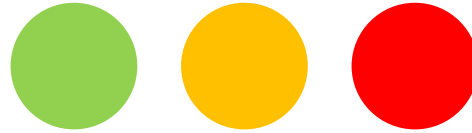
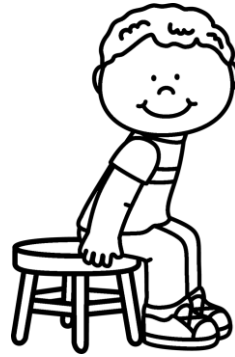

Tara West - Little Minds at Work

CVC Encoding

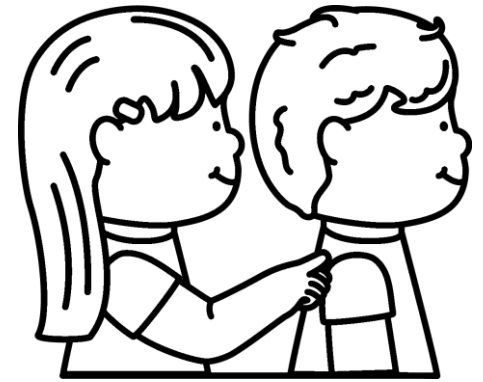

Tara West - Little Minds at Work

CVC Encoding

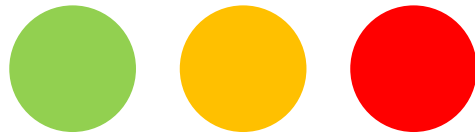
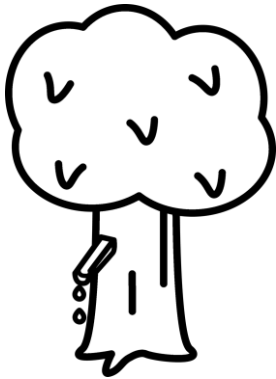

Tara West - Little Minds at Work

CVC Encoding

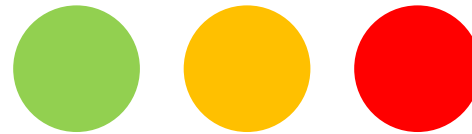

Tara West - Little Minds at Work

CVC Encoding

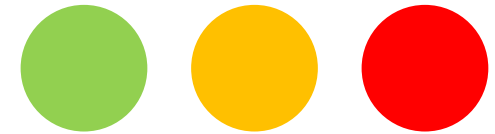
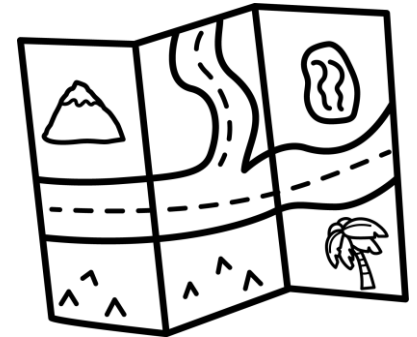

Tara West - Little Minds at Work

CVC Encoding

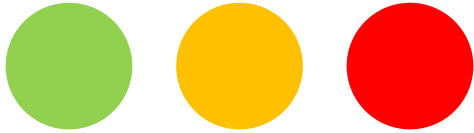
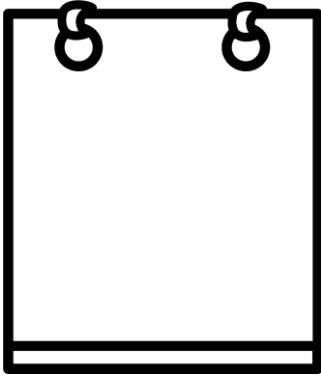

Tara West - Little Minds at Work

CVC Encoding

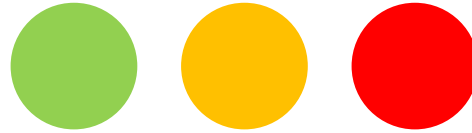
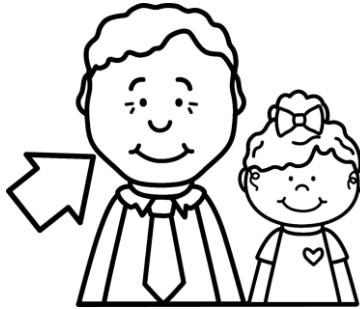

Tara West - Little Minds at Work

CVC Encoding



Tara West - Little Minds at Work

CVC Encoding

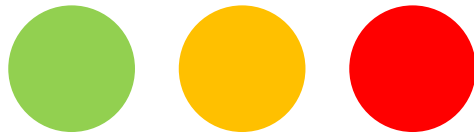

Tara West - Little Minds at Work

CVC Encoding

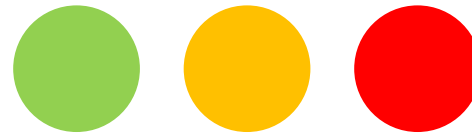

Tara West - Little Minds at Work

CVC Encoding

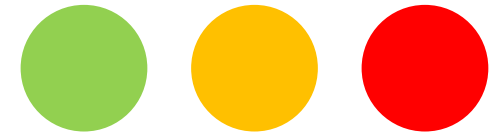

Tara West - Little Minds at Work

CVC Encoding

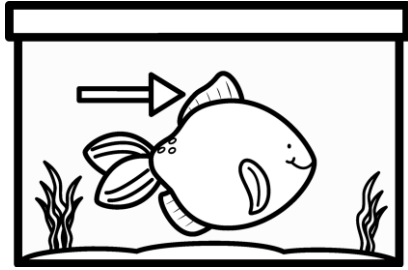

Tara West - Little Minds at Work

CVC Encoding

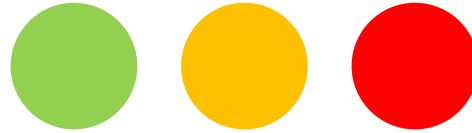
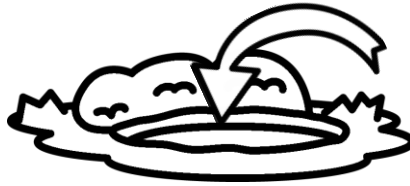

Tara West - Little Minds at Work

CVC Encoding

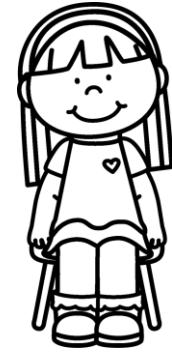

Tara West - Little Minds at Work

CVC Encoding

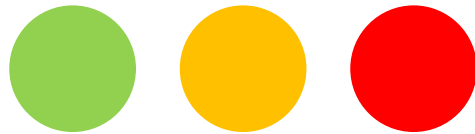
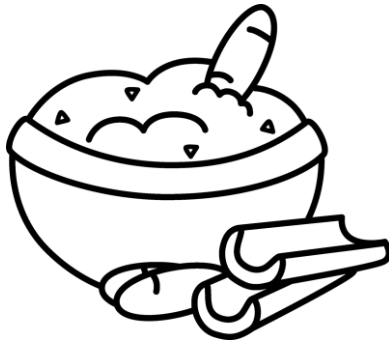

Tara West - Little Minds at Work

CVC Encoding

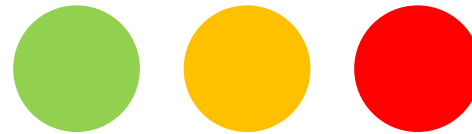
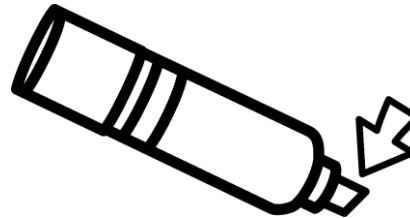

Tara West - Little Minds at Work

CVC Encoding

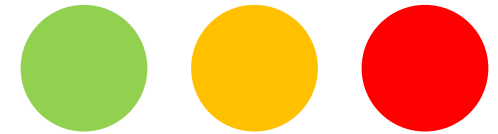
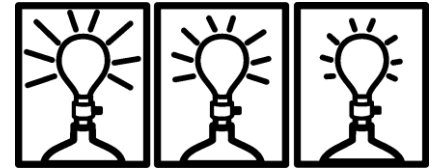

Tara West - Little Minds at Work

CVC Encoding

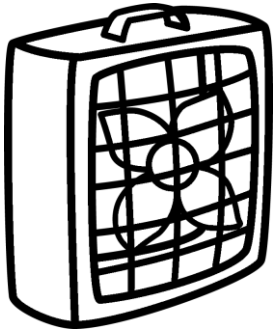

Tara West - Little Minds at Work

CVC Encoding



Tara West - Little Minds at Work

CVC Encoding



Tara West - Little Minds at Work

CVC Encoding

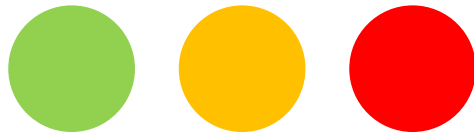
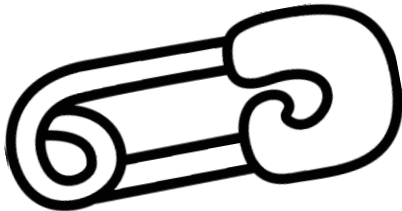

Tara West - Little Minds at Work

CVC Encoding

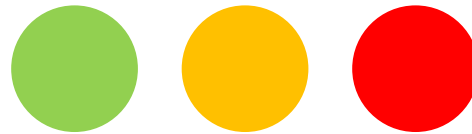
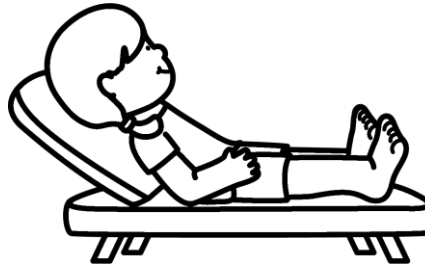

Tara West - Little Minds at Work

CVC Encoding

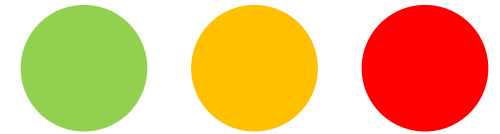

Tara West - Little Minds at Work

CVC Encoding

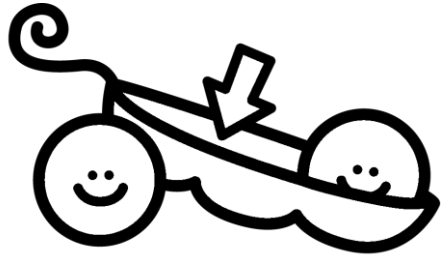

Tara West - Little Minds at Work

CVC Encoding

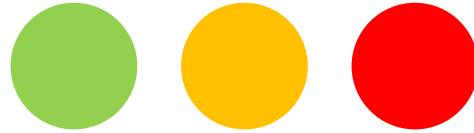

Tara West - Little Minds at Work

CVC Encoding

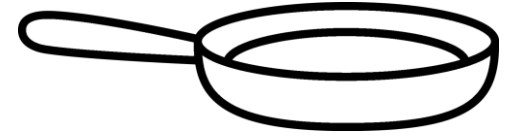

Tara West - Little Minds at Work

CVC Encoding

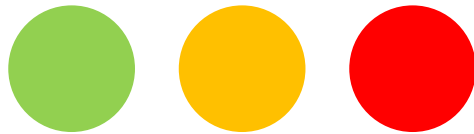
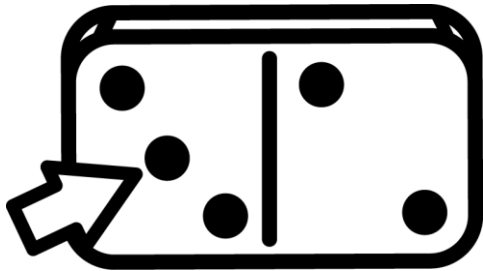

Tara West - Little Minds at Work

CVC Encoding

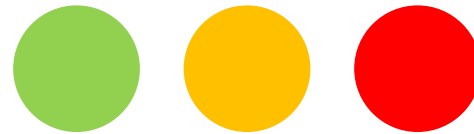
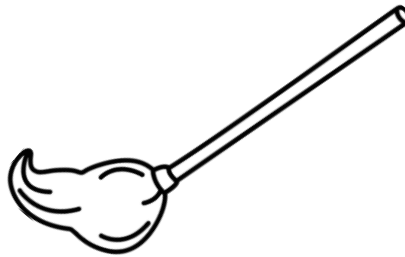

Tara West - Little Minds at Work

CVC Encoding

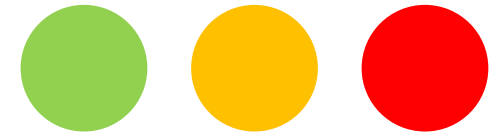
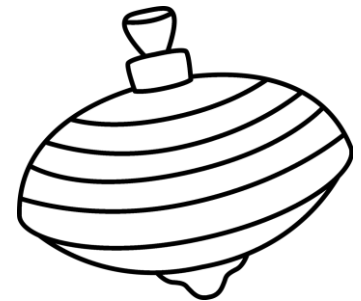

Tara West - Little Minds at Work

CVC Encoding

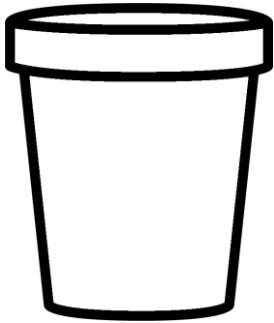

Tara West - Little Minds at Work

CVC Encoding

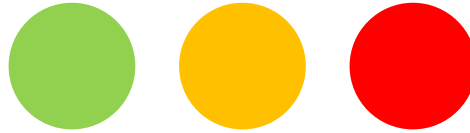
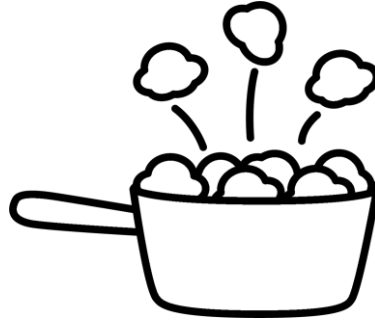

Tara West - Little Minds at Work

CVC Encoding

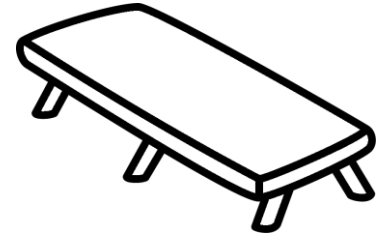

Tara West - Little Minds at Work

CVC Encoding

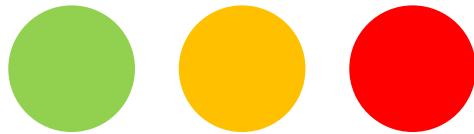

Tara West - Little Minds at Work

CVC Encoding

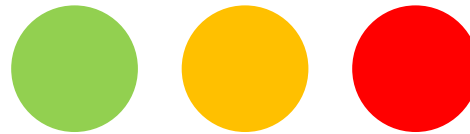
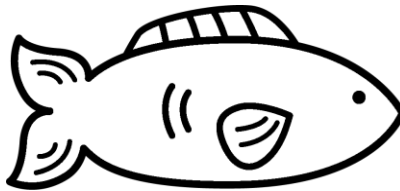

Tara West - Little Minds at Work

CVC Encoding

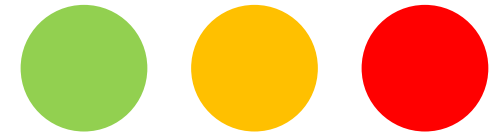

Tara West - Little Minds at Work

CVC Encoding



Tara West - Little Minds at Work

CVC Encoding

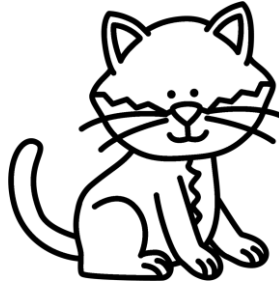

Tara West - Little Minds at Work

CVC Encoding

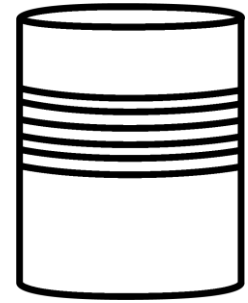

Tara West - Little Minds at Work

CVC Encoding

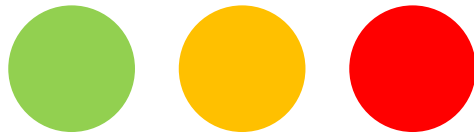
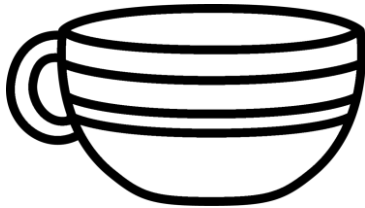

Tara West - Little Minds at Work

CVC Encoding

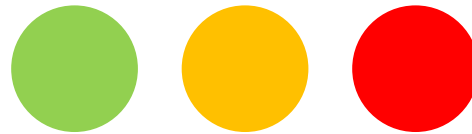
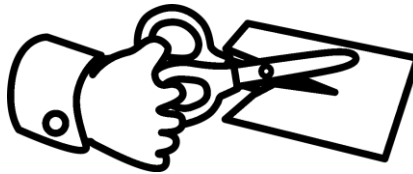

Tara West - Little Minds at Work

CVC Encoding

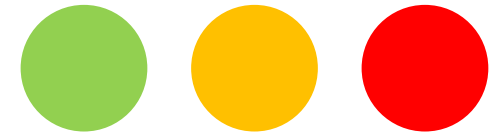
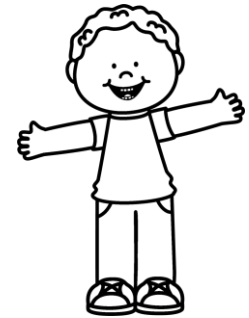

Tara West - Little Minds at Work

CVC Encoding

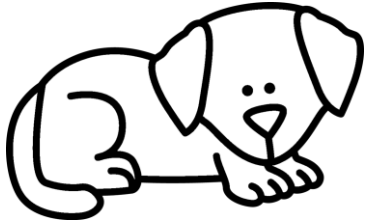

Tara West - Little Minds at Work

CVC Encoding

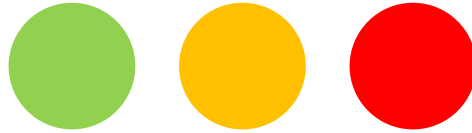

Tara West - Little Minds at Work

CVC Encoding

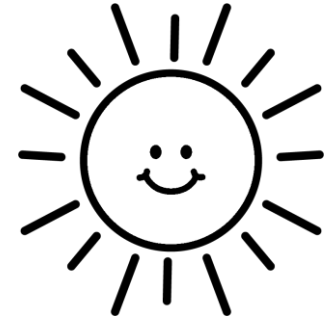

Tara West - Little Minds at Work

CVC Encoding

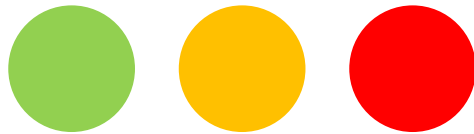
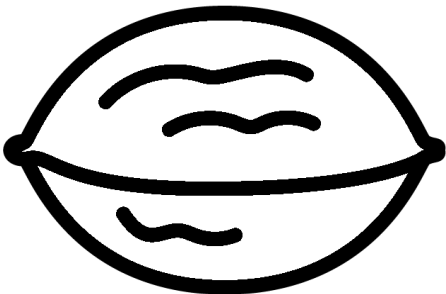

Tara West - Little Minds at Work

CVC Encoding

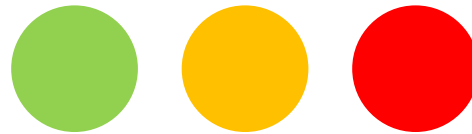
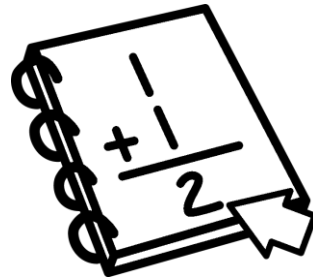

Tara West - Little Minds at Work

CVC Encoding

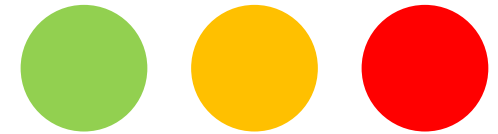
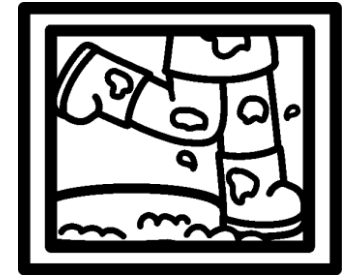

Tara West - Little Minds at Work

CVC Encoding



Tara West - Little Minds at Work

CVC Encoding



Tara West - Little Minds at Work

CVC Encoding

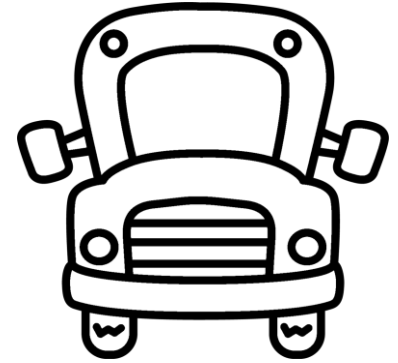

Tara West - Little Minds at Work

CVC Encoding

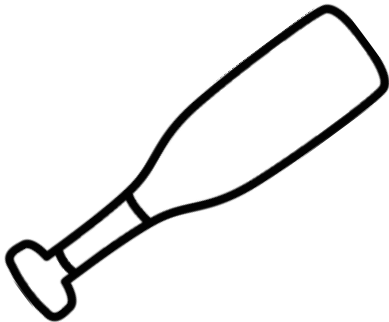

Tara West - Little Minds at Work

CVC Encoding

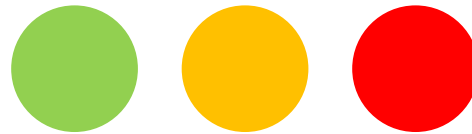

Tara West - Little Minds at Work

CVC Encoding

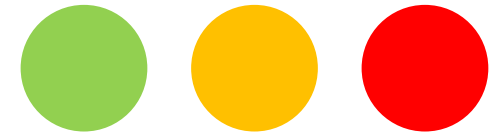

Tara West - Little Minds at Work

CVC Encoding



Tara West - Little Minds at Work

CVC Encoding

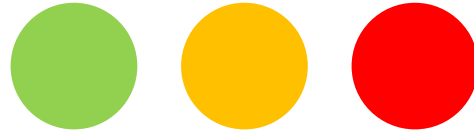
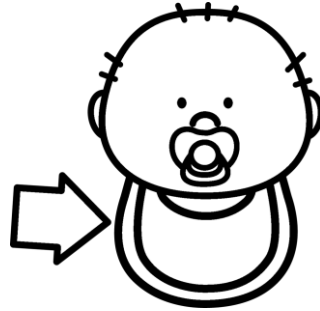

Tara West - Little Minds at Work

CVC Encoding

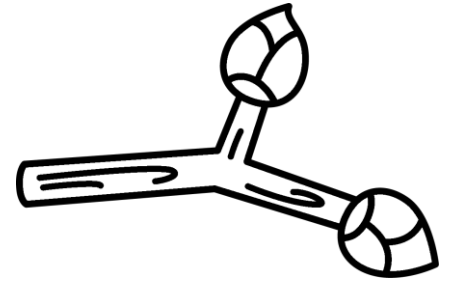

Tara West - Little Minds at Work

CVC Encoding

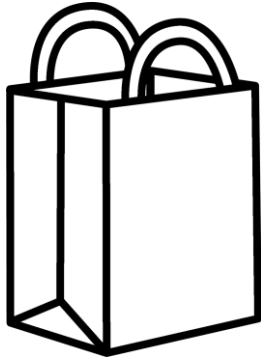

Tara West - Little Minds at Work

CVC Encoding

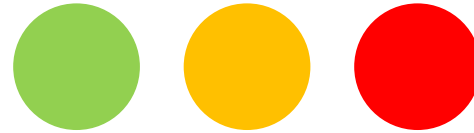

Tara West - Little Minds at Work

CVC Encoding

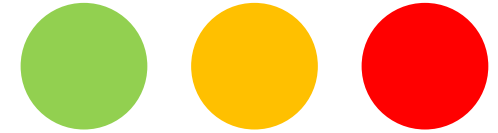
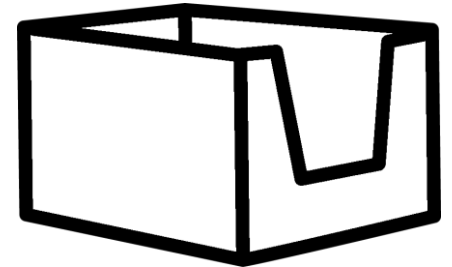

Tara West - Little Minds at Work

CVC Encoding



Tara West - Little Minds at Work

CVC Encoding

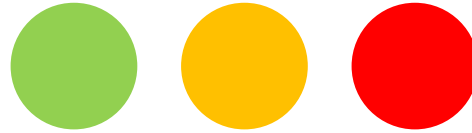
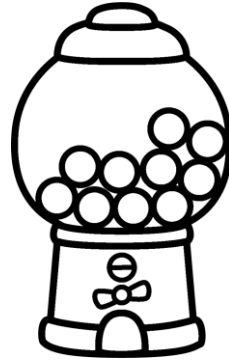

Tara West - Little Minds at Work

CVC Encoding



Tara West - Little Minds at Work

CVC Encoding

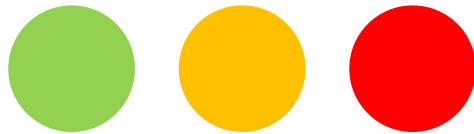

Tara West - Little Minds at Work

CVC Encoding

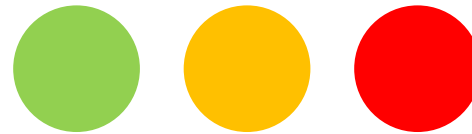

Tara West - Little Minds at Work

CVC Encoding

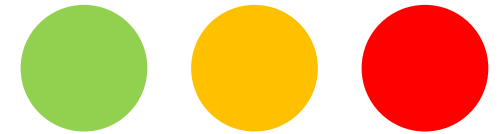
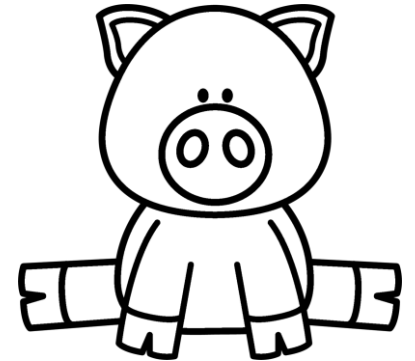

Tara West - Little Minds at Work

CVC Encoding



Tara West - Little Minds at Work

CVC Encoding

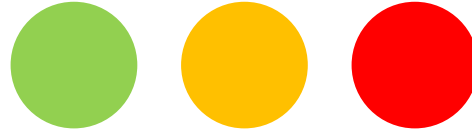
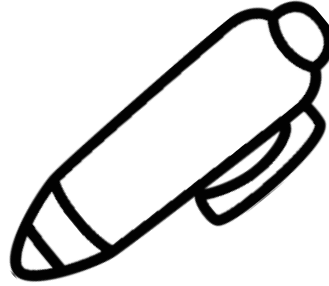

Tara West - Little Minds at Work

CVC Encoding

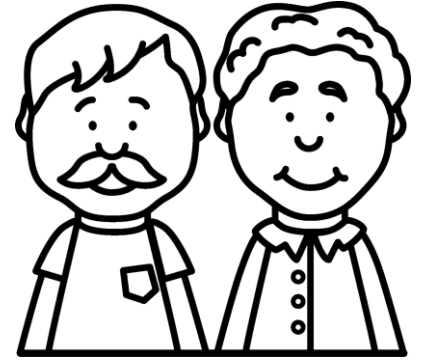

Tara West - Little Minds at Work

CVC Encoding

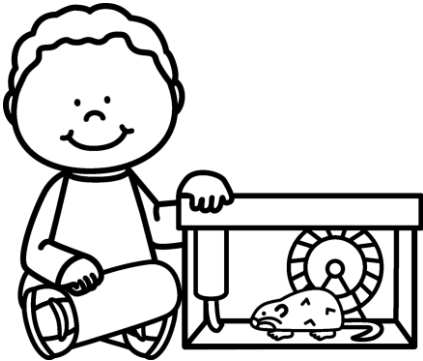

Tara West - Little Minds at Work

CVC Encoding

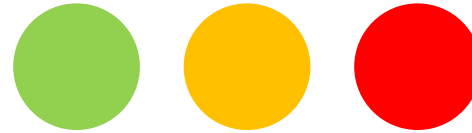
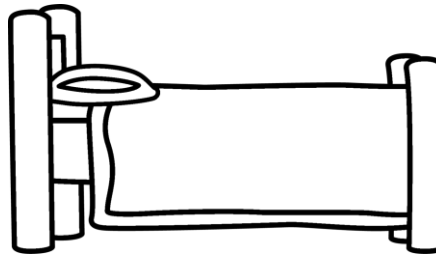

Tara West - Little Minds at Work

CVC Encoding

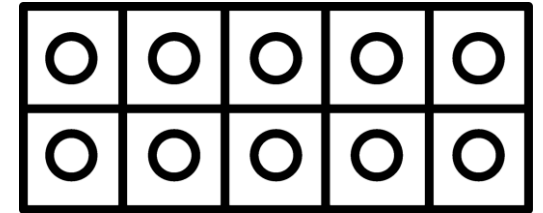

Tara West - Little Minds at Work

CVC Encoding

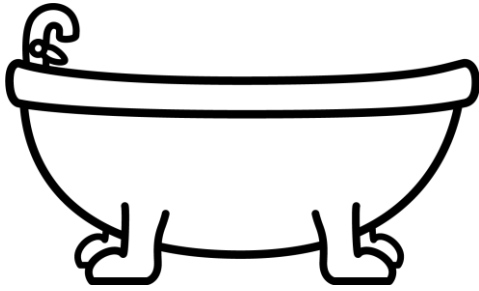

Tara West - Little Minds at Work

CVC Encoding

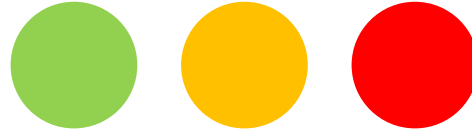
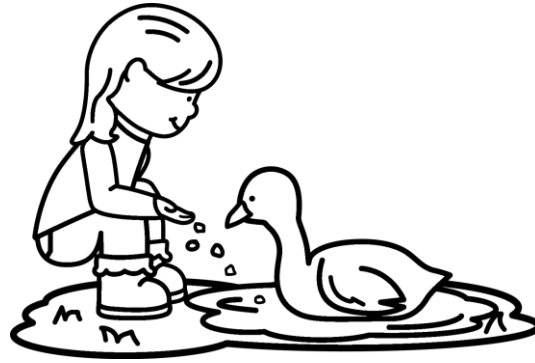

Tara West - Little Minds at Work

CVC Encoding

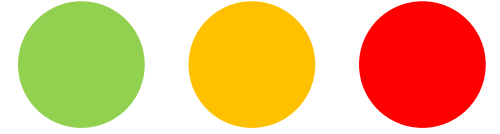
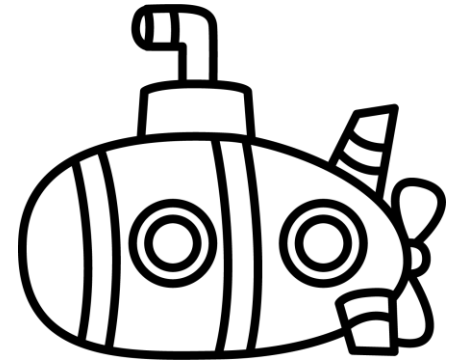

Tara West - Little Minds at Work

CVC Encoding

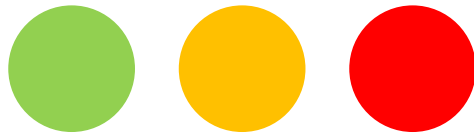
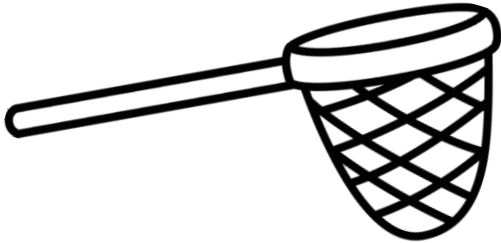

Tara West - Little Minds at Work

CVC Encoding

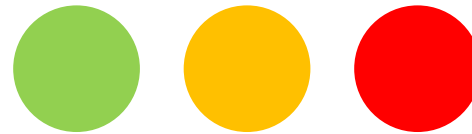

Tara West - Little Minds at Work

CVC Encoding



Tara West - Little Minds at Work

CVC Encoding

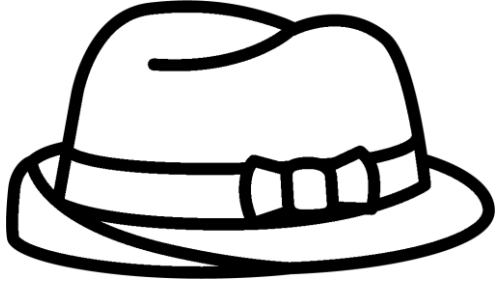

Tara West - Little Minds at Work

CVC Encoding

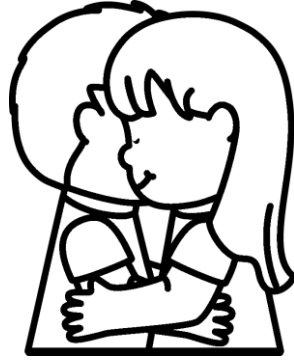

Tara West - Little Minds at Work

CVC Encoding

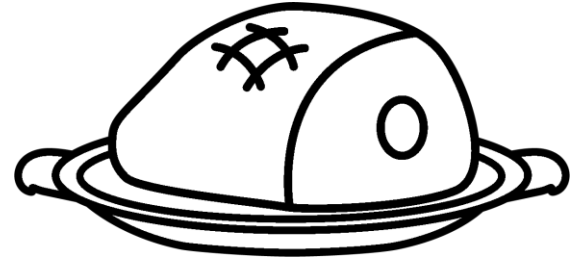

Tara West - Little Minds at Work

CVC Encoding

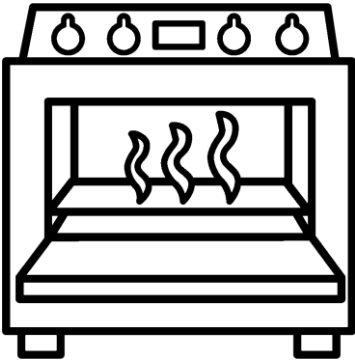

Tara West - Little Minds at Work

CVC Encoding

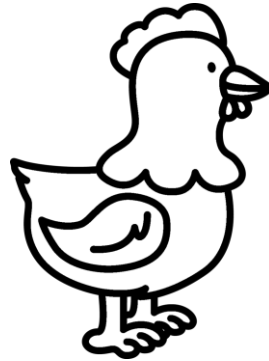

Tara West - Little Minds at Work

CVC Encoding

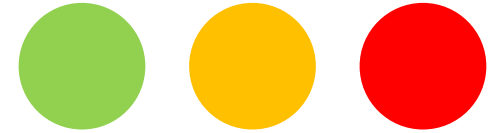
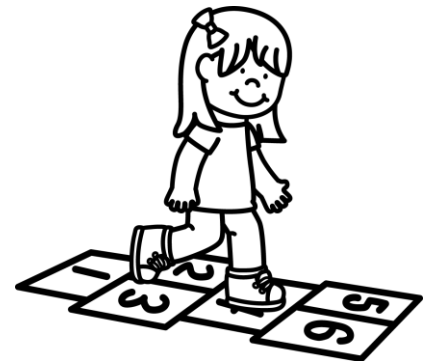

Tara West - Little Minds at Work

CVC Encoding



Tara West - Little Minds at Work

CVC Encoding

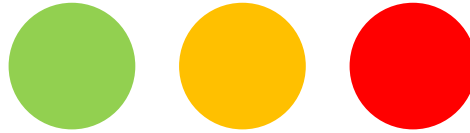
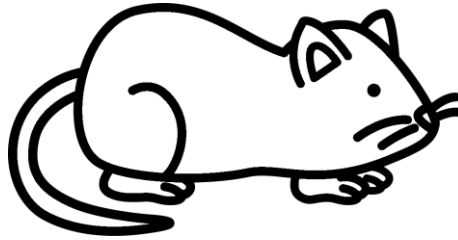

Tara West - Little Minds at Work

CVC Encoding

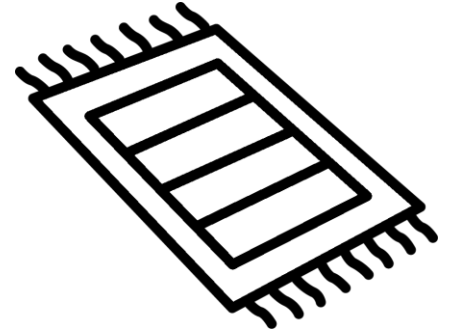

Tara West - Little Minds at Work

CVC Encoding

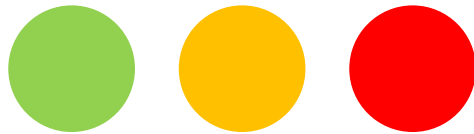
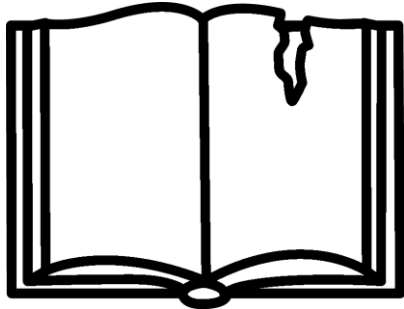

Tara West - Little Minds at Work

CVC Encoding

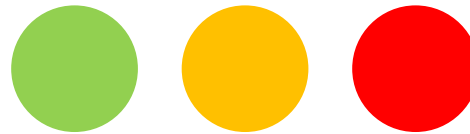

Tara West - Little Minds at Work

CVC Encoding

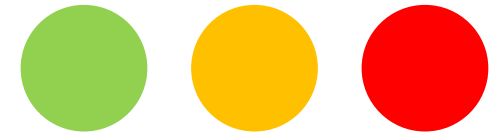
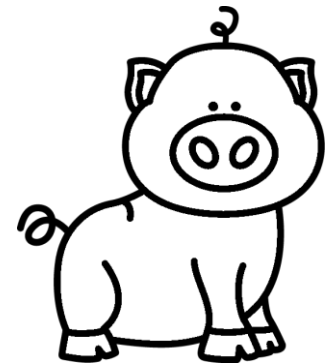

Tara West - Little Minds at Work

CVC Encoding

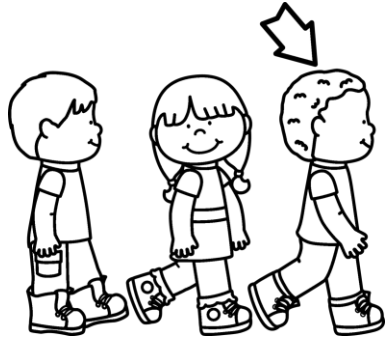

Tara West - Little Minds at Work

CVC Encoding

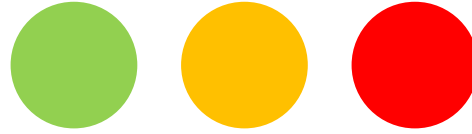

Tara West - Little Minds at Work

CVC Encoding

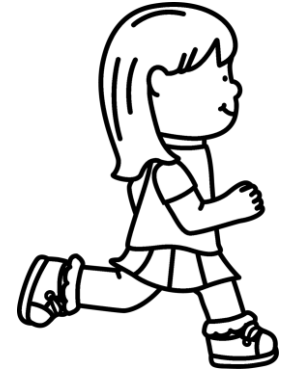

Tara West - Little Minds at Work

CVC Encoding

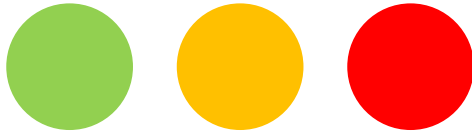
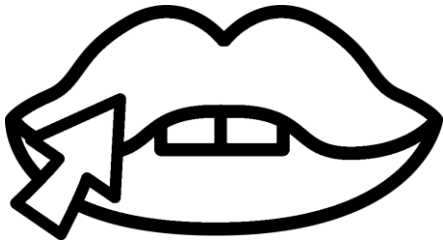

Tara West - Little Minds at Work

CVC Encoding

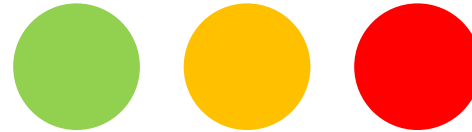
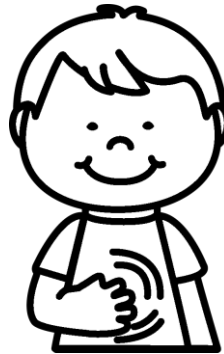

Tara West - Little Minds at Work

CVC Encoding

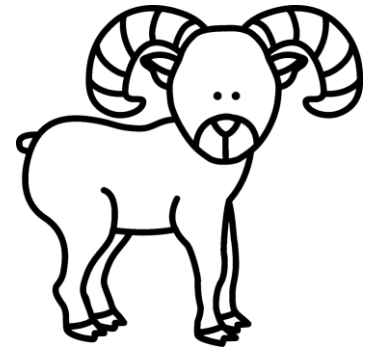

Tara West - Little Minds at Work

CVC Encoding

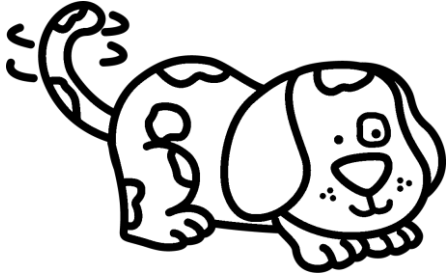

Tara West - Little Minds at Work

CVC Encoding

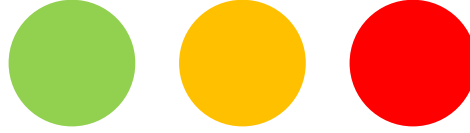
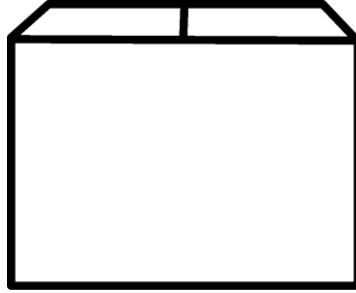

Tara West - Little Minds at Work

CVC Encoding



Tara West - Little Minds at Work

CVC Encoding

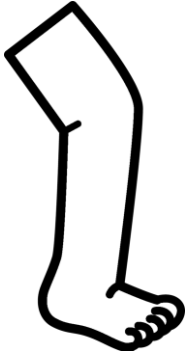

Tara West - Little Minds at Work

CVC Encoding

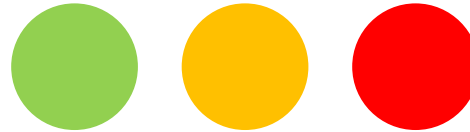

Tara West - Little Minds at Work

CVC Encoding

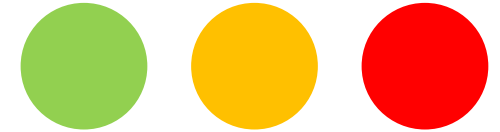
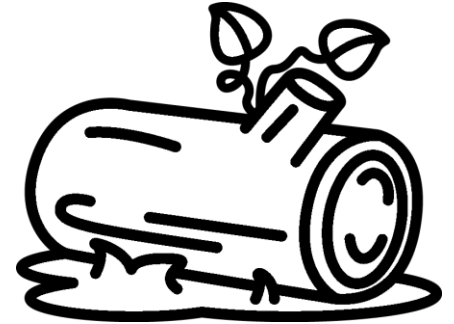

Tara West - Little Minds at Work

CVC Encoding



Tara West - Little Minds at Work

CVC Encoding

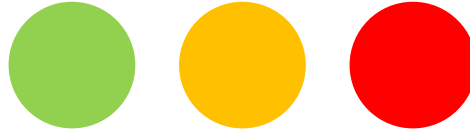
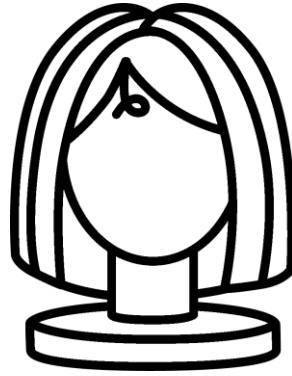

Tara West - Little Minds at Work

CVC Encoding

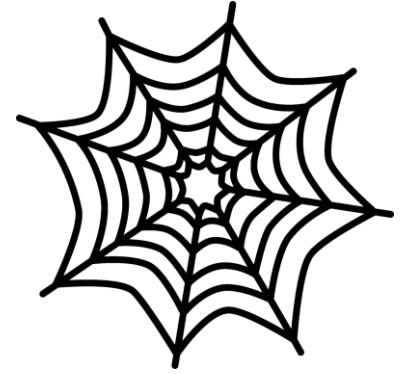

Tara West - Little Minds at Work

CVC Encoding

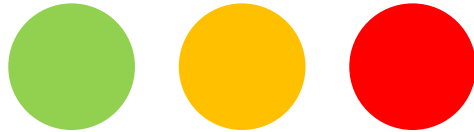
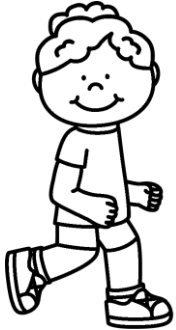

Tara West - Little Minds at Work

CVC Encoding

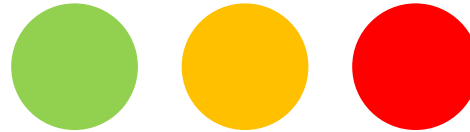
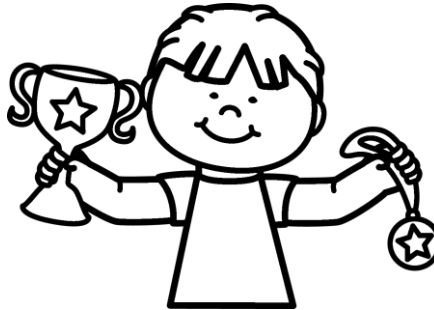

Tara West - Little Minds at Work

CVC Encoding

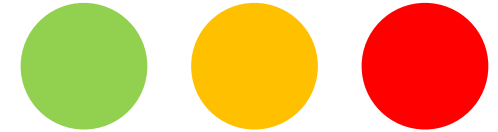

Tara West - Little Minds at Work

CVC Encoding

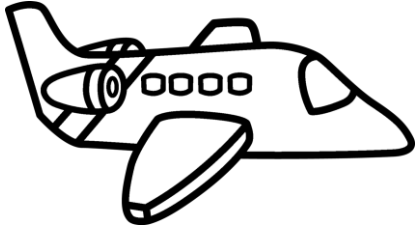

Tara West - Little Minds at Work

CVC Encoding

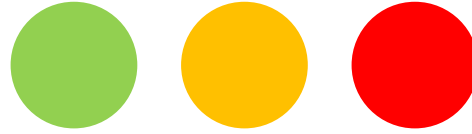
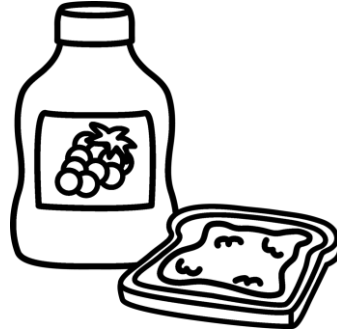

Tara West - Little Minds at Work

CVC Encoding

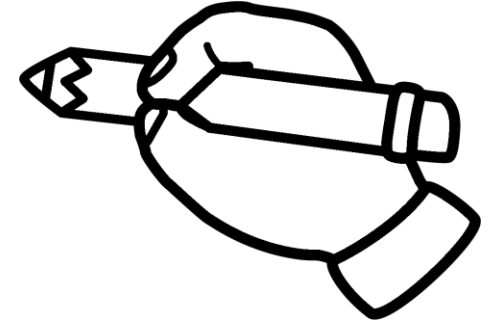

Tara West - Little Minds at Work

CVC Encoding

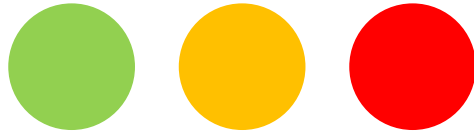

Tara West - Little Minds at Work

CVC Encoding

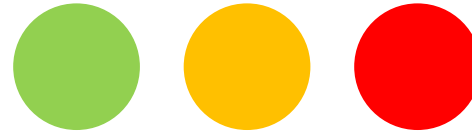

Tara West - Little Minds at Work

CVC Encoding



Tara West - Little Minds at Work

CVC Encoding

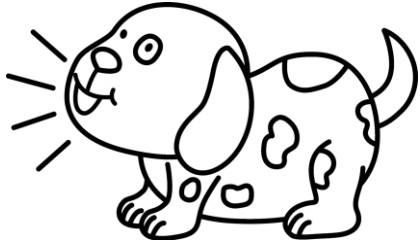

Tara West - Little Minds at Work

CVC Encoding

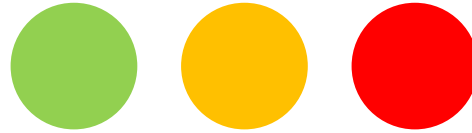

Tara West - Little Minds at Work

CVC Encoding



Tara West - Little Minds at Work

CVC Encoding

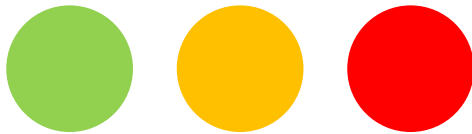
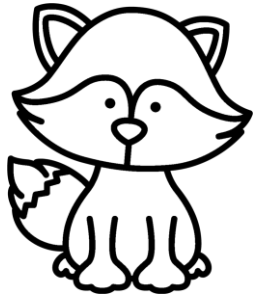

Tara West - Little Minds at Work

CVC Encoding

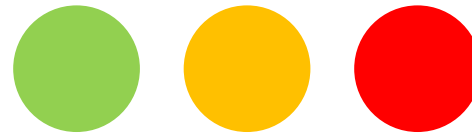
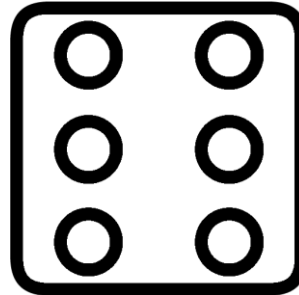

Tara West - Little Minds at Work

CVC Encoding



Tara West - Little Minds at Work

CVC Encoding

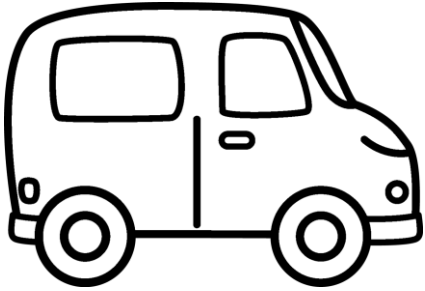

Tara West - Little Minds at Work

CVC Encoding

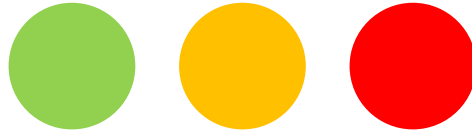
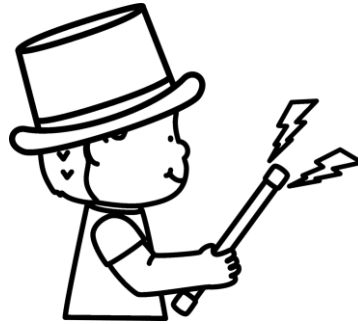

Tara West - Little Minds at Work

CVC Encoding

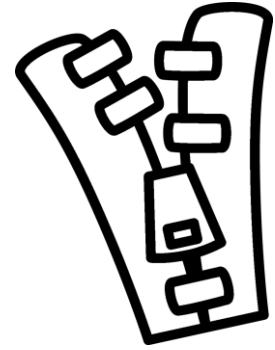

Tara West - Little Minds at Work

CVC Encoding

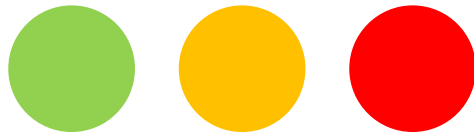

Tara West - Little Minds at Work

Digraphs Encoding

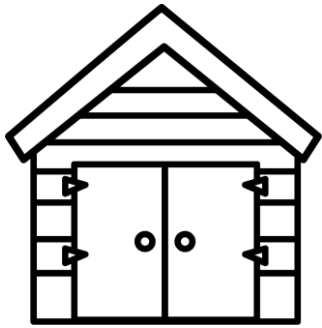

Tara West - Little Minds at Work

Digraphs Encoding

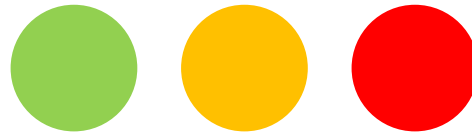

Tara West - Little Minds at Work

Digraphs Encoding



Tara West - Little Minds at Work

Digraphs Encoding

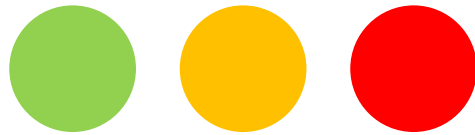
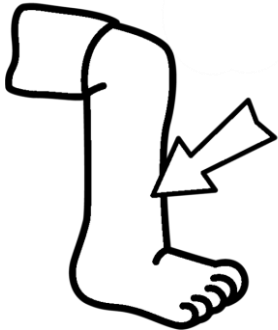

Tara West - Little Minds at Work

Digraphs Encoding

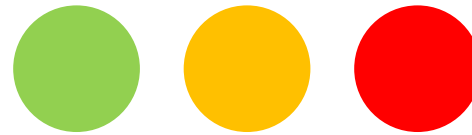

Tara West - Little Minds at Work

Digraphs Encoding

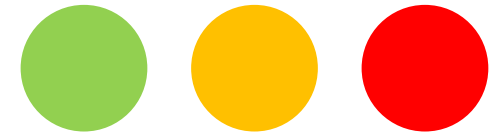
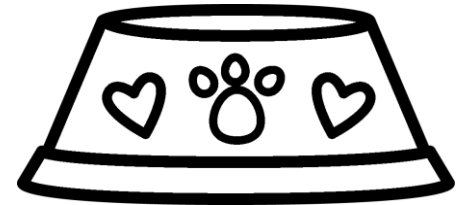

Tara West - Little Minds at Work

Digraphs Encoding

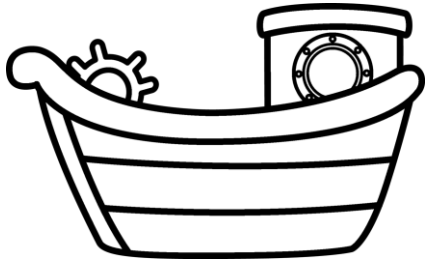

Tara West - Little Minds at Work

Digraphs Encoding

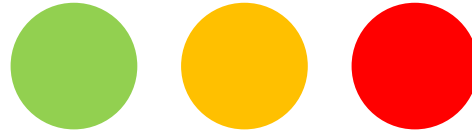

Tara West - Little Minds at Work

Digraphs Encoding

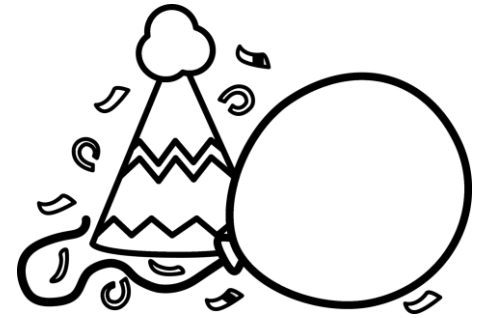

Tara West - Little Minds at Work

Digraphs Encoding

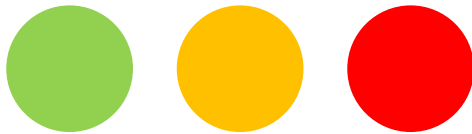

Tara West - Little Minds at Work

Digraphs Encoding

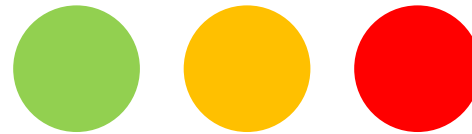
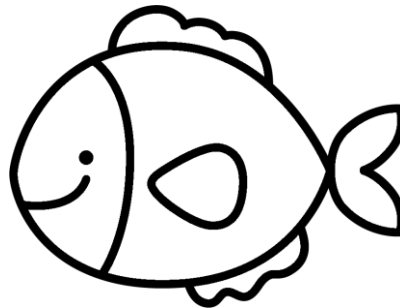

Tara West - Little Minds at Work

Digraphs Encoding

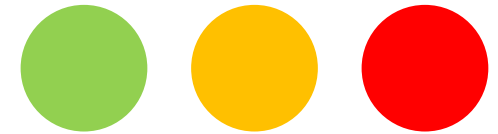
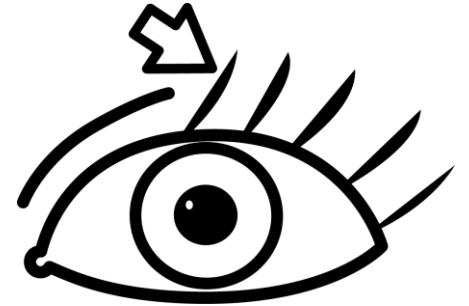

Tara West - Little Minds at Work

Digraphs Encoding



Tara West - Little Minds at Work

Digraphs Encoding

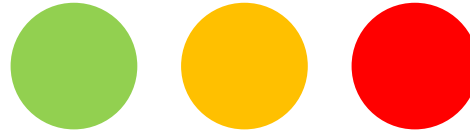
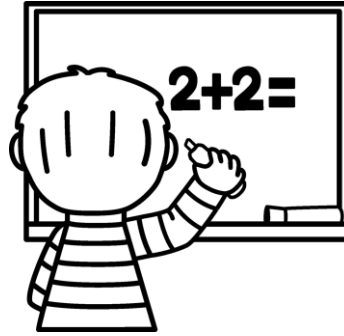

Tara West - Little Minds at Work

Digraphs Encoding



Tara West - Little Minds at Work

Digraphs Encoding

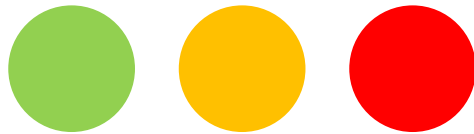
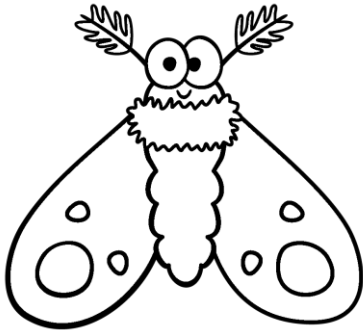

Tara West - Little Minds at Work

Digraphs Encoding

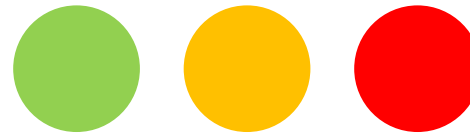
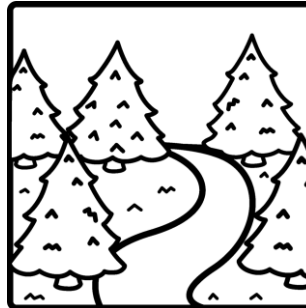

Tara West - Little Minds at Work

Digraphs Encoding

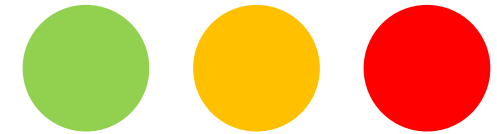
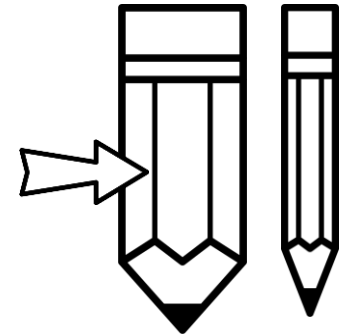

Tara West - Little Minds at Work

Digraphs Encoding



Tara West - Little Minds at Work

Digraphs Encoding

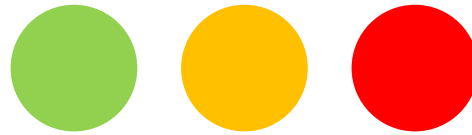
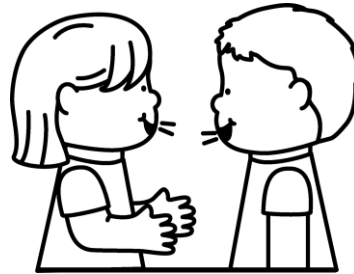

Tara West - Little Minds at Work

Digraphs Encoding

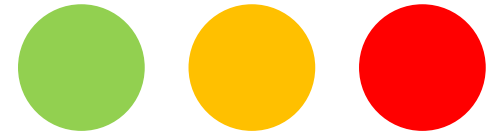

Tara West - Little Minds at Work

Digraphs Encoding

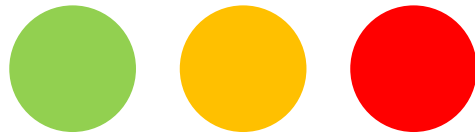

Tara West - Little Minds at Work

Digraphs Encoding

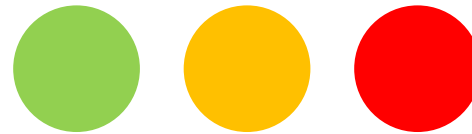
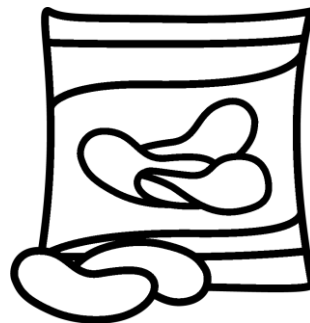

Tara West - Little Minds at Work

Digraphs Encoding

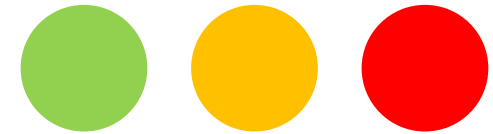
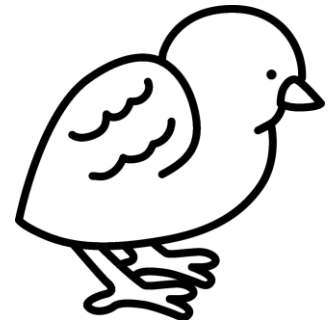

Tara West - Little Minds at Work

Digraphs Encoding



Tara West - Little Minds at Work

Digraphs Encoding

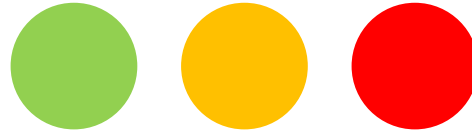

Tara West - Little Minds at Work

Digraphs Encoding



Tara West - Little Minds at Work

Digraphs Encoding

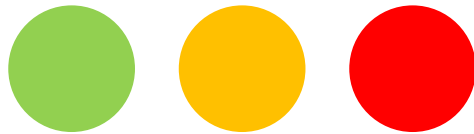
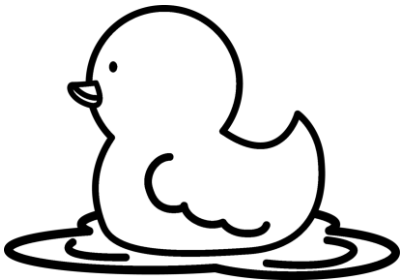

Tara West - Little Minds at Work

Digraphs Encoding

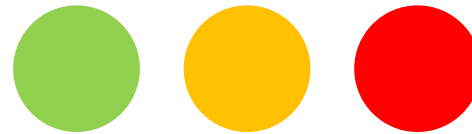

Tara West - Little Minds at Work

Digraphs Encoding

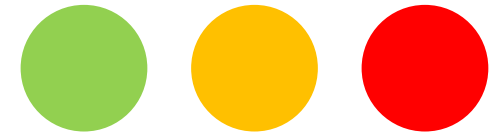
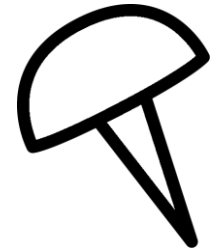

Tara West - Little Minds at Work

Double Endings Encoding

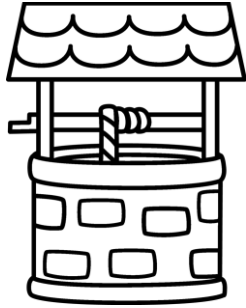

Tara West - Little Minds at Work

Double Endings Encoding

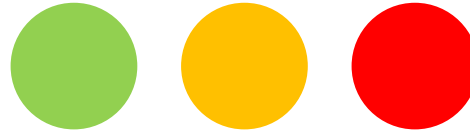

Tara West - Little Minds at Work

Double Endings Encoding

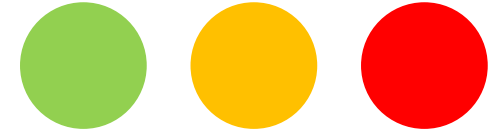

Tara West - Little Minds at Work

Double Endings Encoding

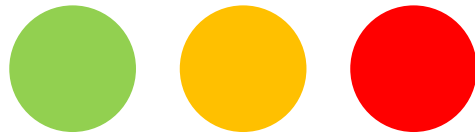

Tara West - Little Minds at Work

Double Endings Encoding

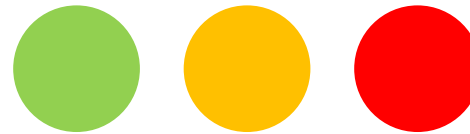
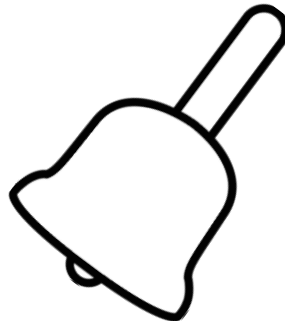

Tara West - Little Minds at Work

Double Endings Encoding

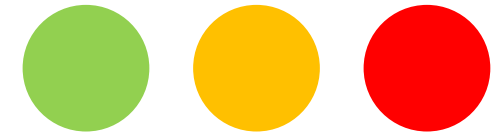
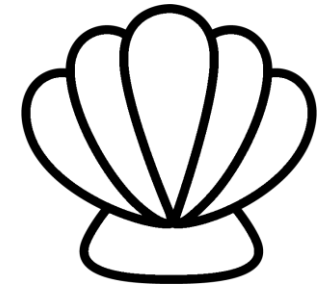

Tara West - Little Minds at Work

Double Endings Encoding



Tara West - Little Minds at Work

Double Endings Encoding

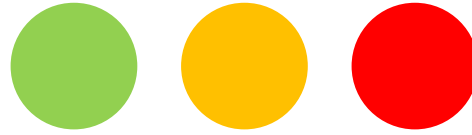
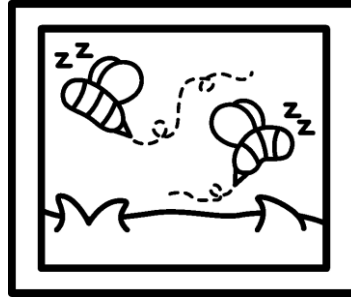

Tara West - Little Minds at Work

Double Endings Encoding

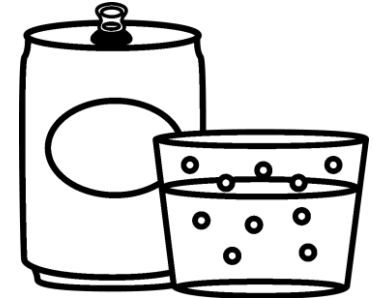

Tara West - Little Minds at Work

Double Endings Encoding

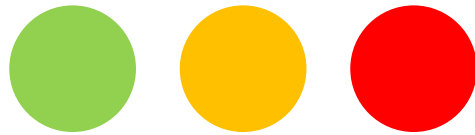

Tara West - Little Minds at Work

Double Endings Encoding

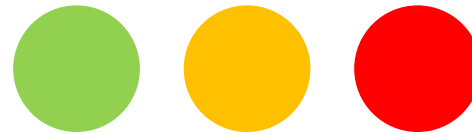
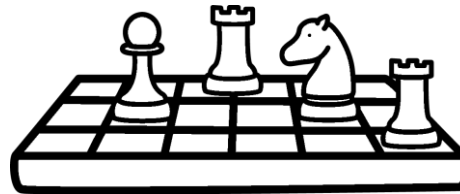

Tara West - Little Minds at Work

Double Endings Encoding

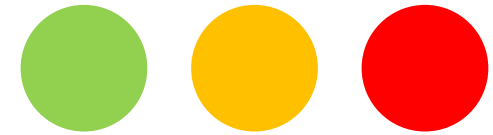
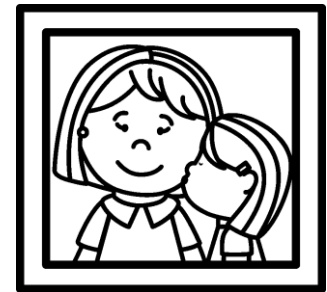

Tara West - Little Minds at Work

CCVC Encoding

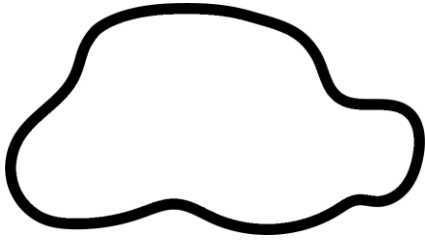

Tara West - Little Minds at Work

CCVC Encoding

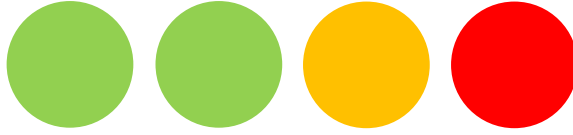
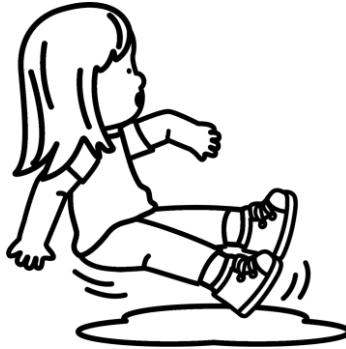

Tara West - Little Minds at Work

CCVC Encoding

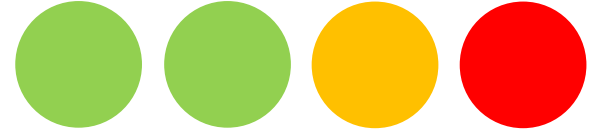
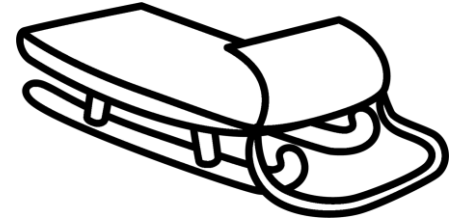

Tara West - Little Minds at Work

CCVC Encoding

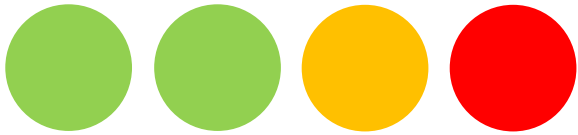

Tara West - Little Minds at Work

CCVC Encoding

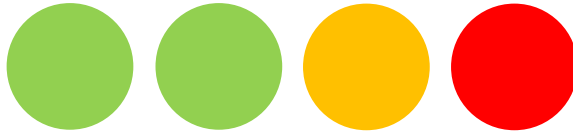
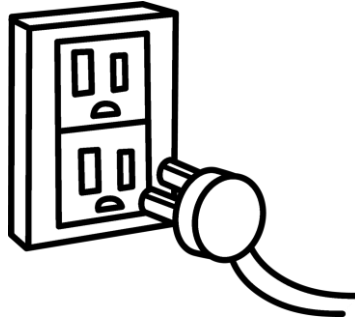

Tara West - Little Minds at Work

CCVC Encoding

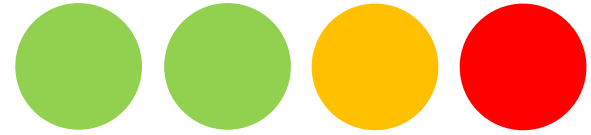
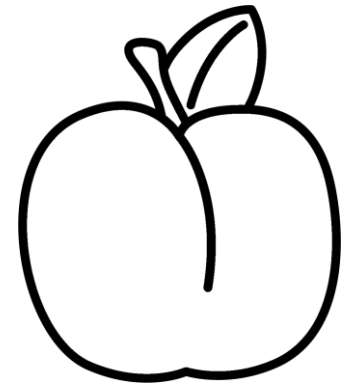

Tara West - Little Minds at Work

CCVC Encoding

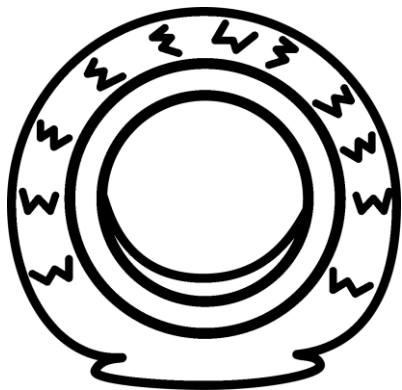

Tara West - Little Minds at Work

CCVC Encoding

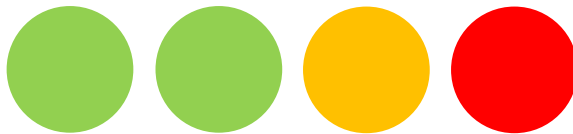
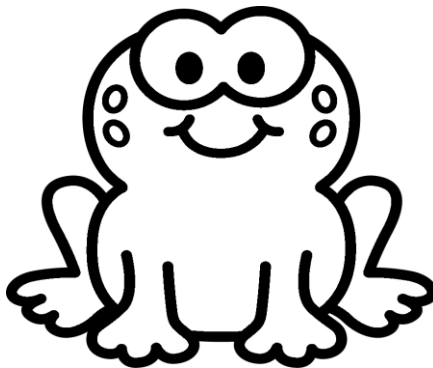

Tara West - Little Minds at Work

CCVC Encoding

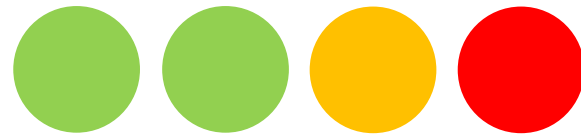
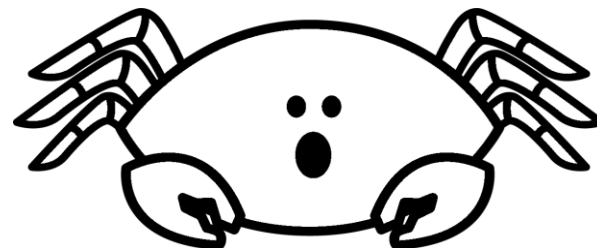

Tara West - Little Minds at Work

CCVC Encoding

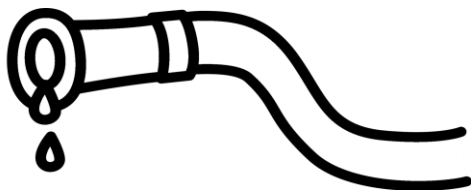

Tara West - Little Minds at Work

CCVC Encoding

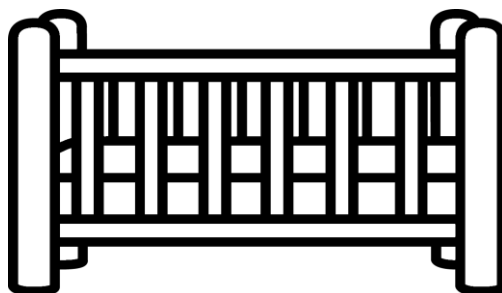

Tara West - Little Minds at Work

CCVC Encoding

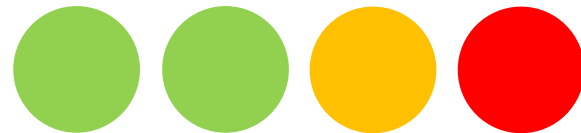

Tara West - Little Minds at Work

CCVC Encoding

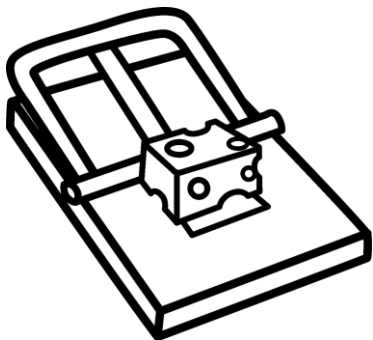

Tara West - Little Minds at Work

CCVC Encoding

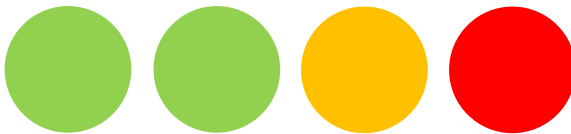

Tara West - Little Minds at Work

CCVC Encoding

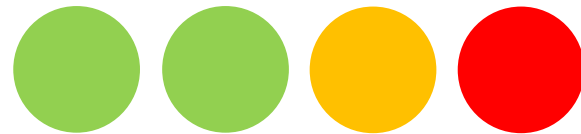

Tara West - Little Minds at Work

CCVC Encoding

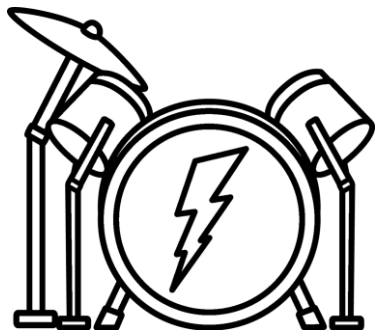

Tara West - Little Minds at Work

CCVC Encoding

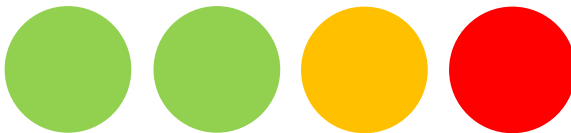

Tara West - Little Minds at Work

CCVC Encoding

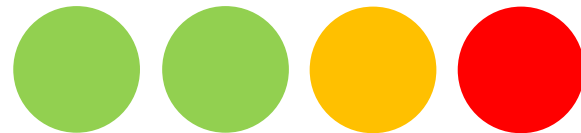
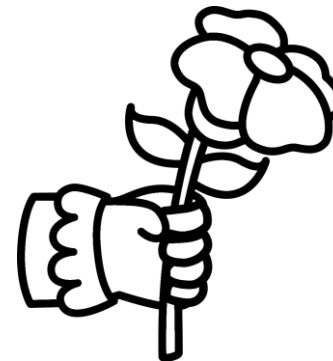

Tara West - Little Minds at Work

CCVC Encoding

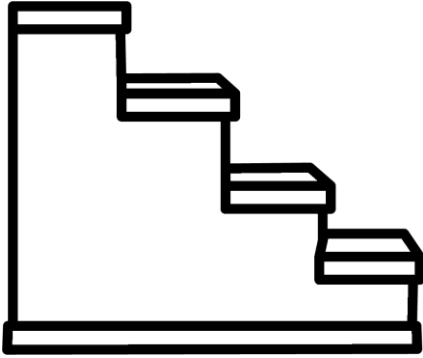

Tara West - Little Minds at Work

CCVC Encoding

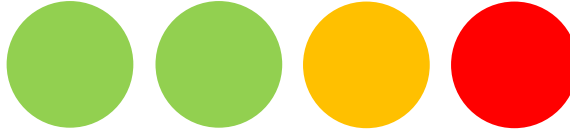

Tara West - Little Minds at Work

CCVC Encoding

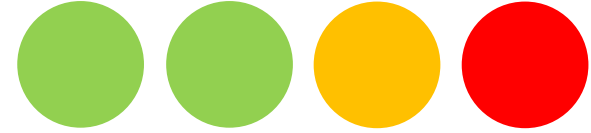
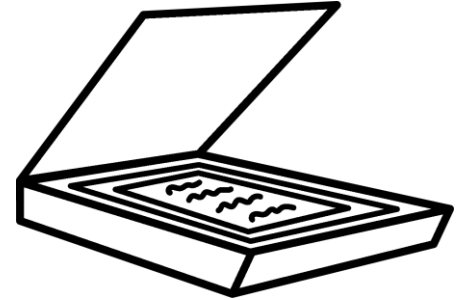

Tara West - Little Minds at Work

CCVC Encoding

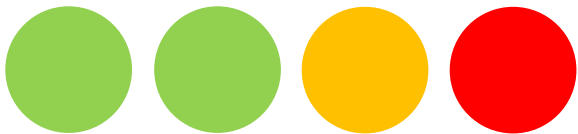
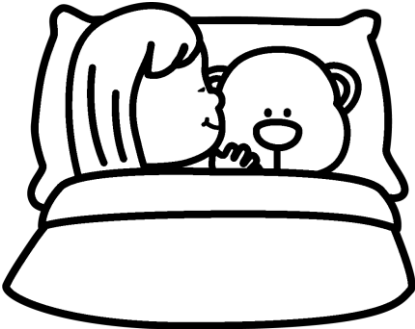

Tara West - Little Minds at Work

CCVC Encoding

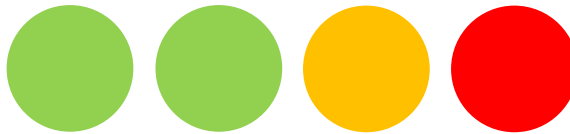

Tara West - Little Minds at Work

CCVC Encoding

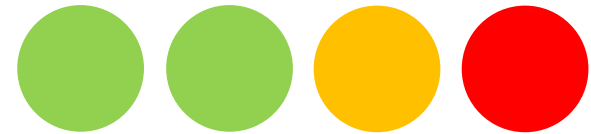

Tara West - Little Minds at Work

CVCE Encoding

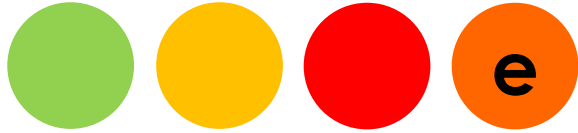
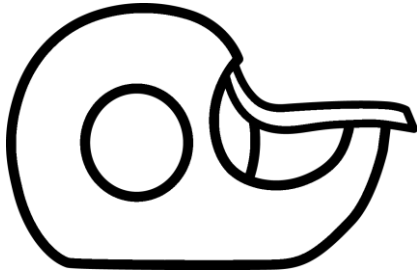

Tara West - Little Minds at Work

CVCE Encoding

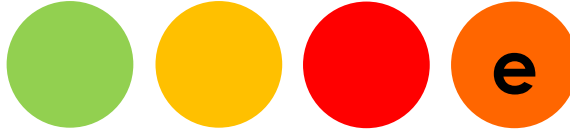
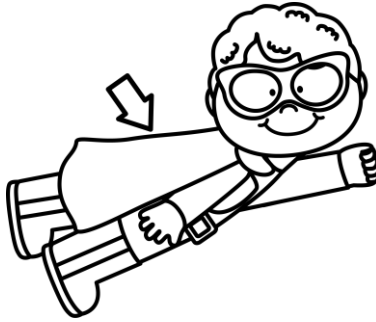

Tara West - Little Minds at Work

CVCE Encoding

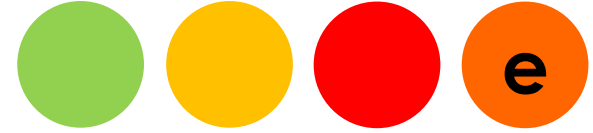

Tara West - Little Minds at Work

CVCE Encoding

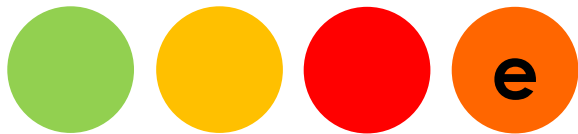
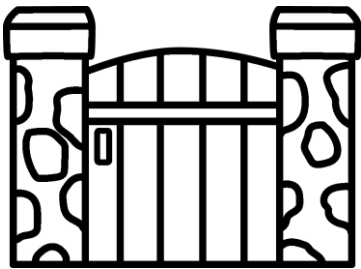

Tara West - Little Minds at Work

CVCE Encoding

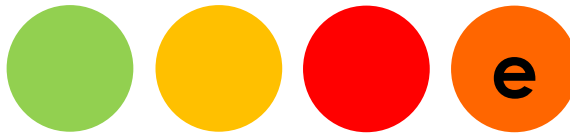

Tara West - Little Minds at Work

CVCE Encoding

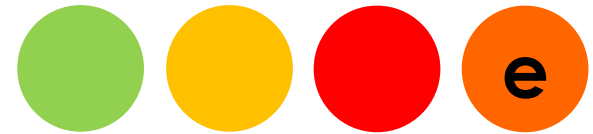
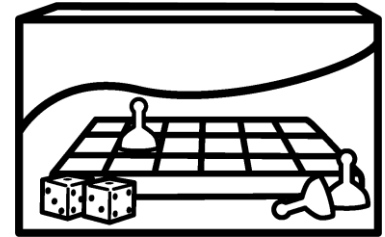

Tara West - Little Minds at Work

CVCE Encoding

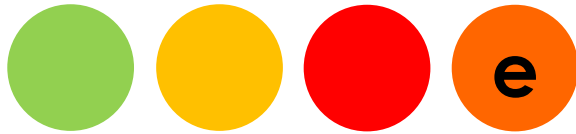

Tara West - Little Minds at Work

CVCE Encoding

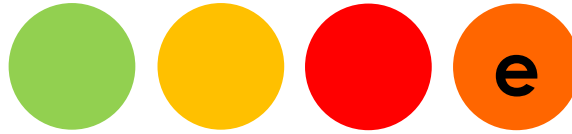

Tara West - Little Minds at Work

CVCE Encoding

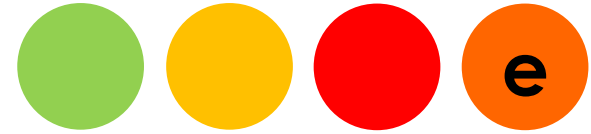

Tara West - Little Minds at Work

CVCE Encoding

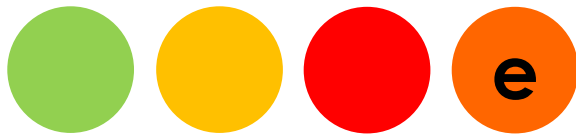
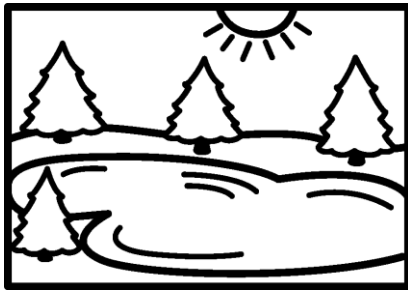

Tara West - Little Minds at Work

CVCE Encoding

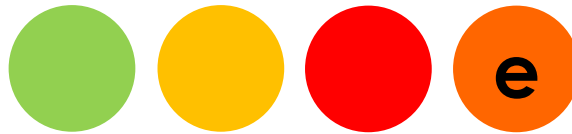

Tara West - Little Minds at Work

CVCE Encoding

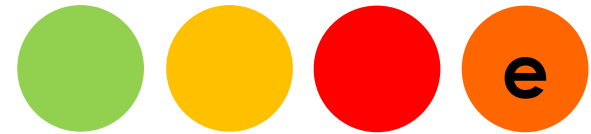

Tara West - Little Minds at Work

CVCE Encoding

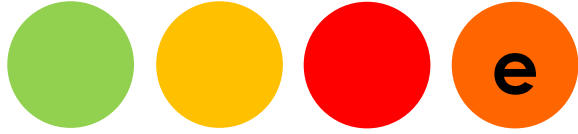

Tara West - Little Minds at Work

CVCE Encoding

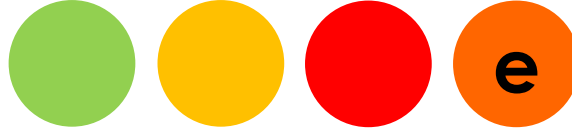
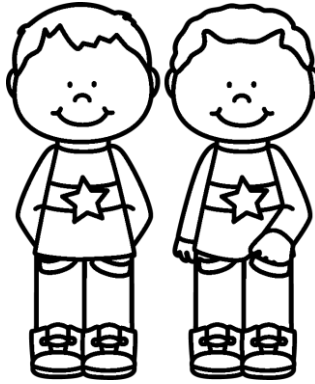

Tara West - Little Minds at Work

CVCE Encoding

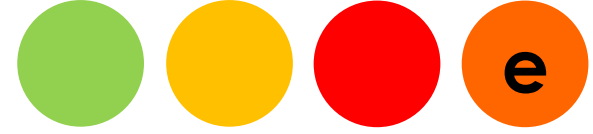
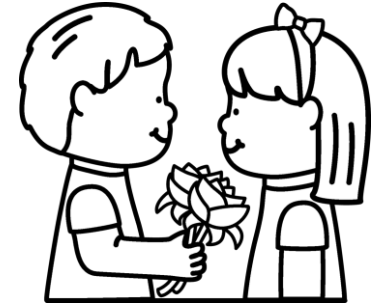

Tara West - Little Minds at Work

CVCE Encoding

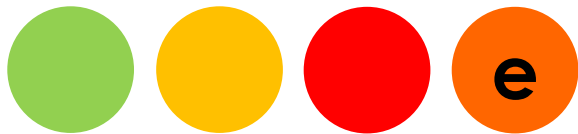

Tara West - Little Minds at Work

CVCE Encoding

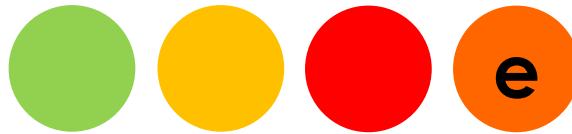

Tara West - Little Minds at Work

CVCE Encoding

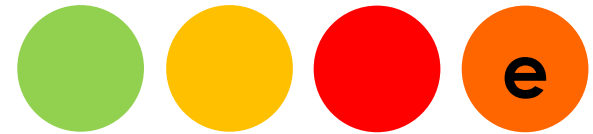
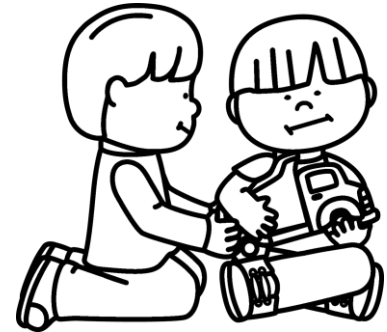

Tara West - Little Minds at Work

CVCE Encoding

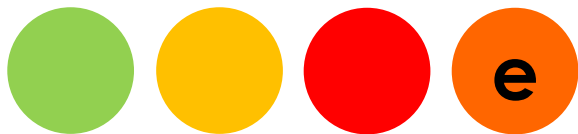
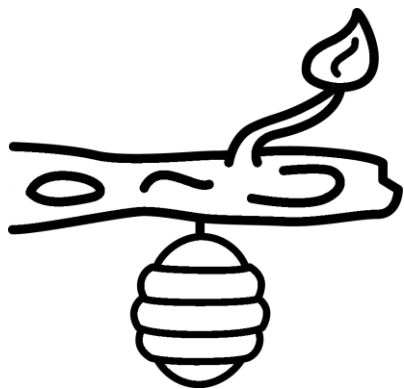

Tara West - Little Minds at Work

CVCE Encoding

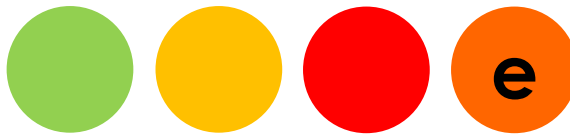
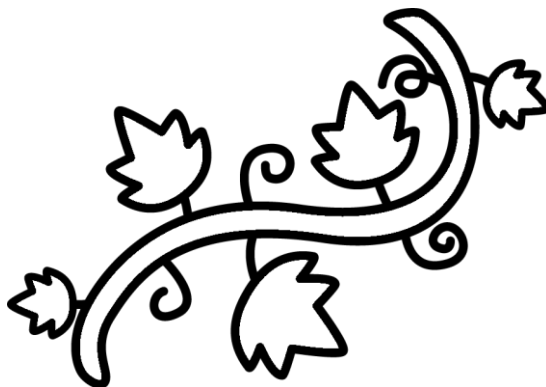

Tara West - Little Minds at Work

CVCE Encoding

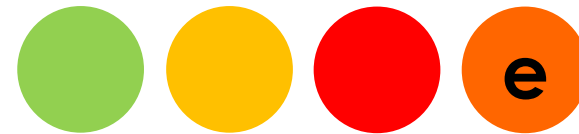
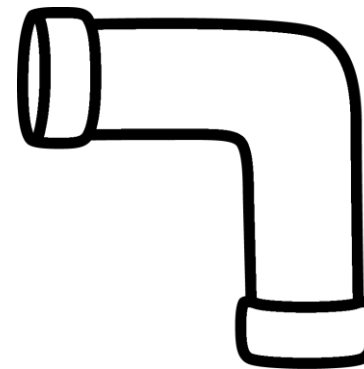

Tara West - Little Minds at Work

CVCE Encoding

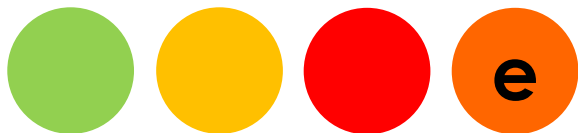
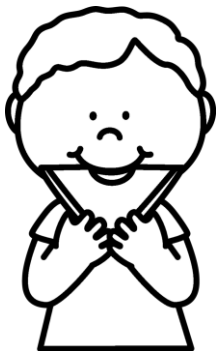

Tara West - Little Minds at Work

CVCE Encoding

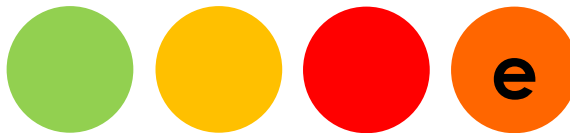
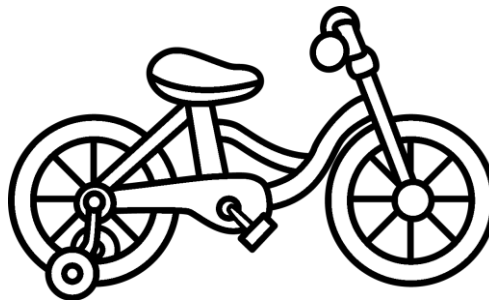

Tara West - Little Minds at Work

CVCE Encoding

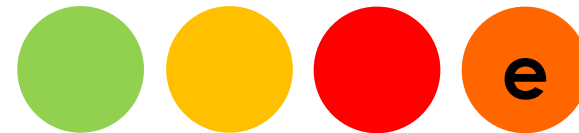

Tara West - Little Minds at Work

CVCE Encoding

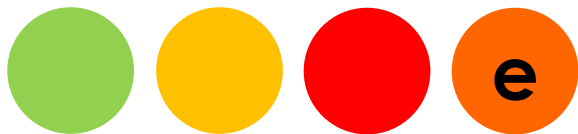
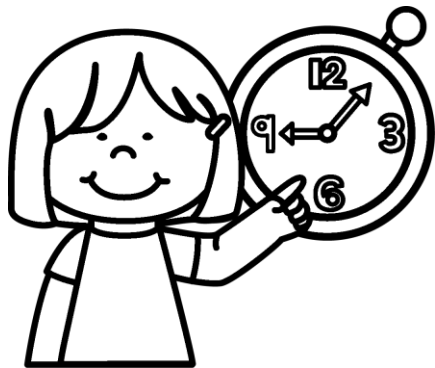

Tara West - Little Minds at Work

CVCE Encoding

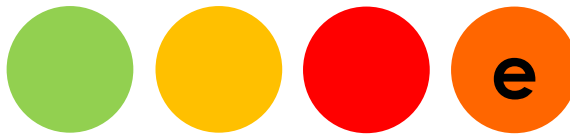

Tara West - Little Minds at Work

CVCE Encoding

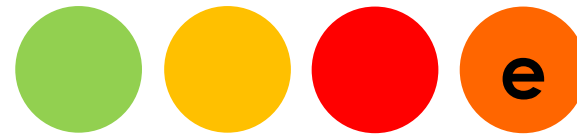

Tara West - Little Minds at Work

CVCE Encoding

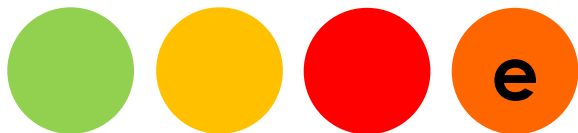

Tara West - Little Minds at Work

CVCE Encoding

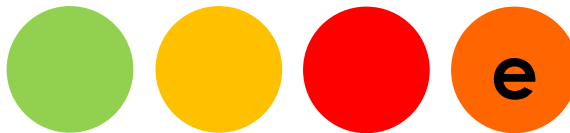
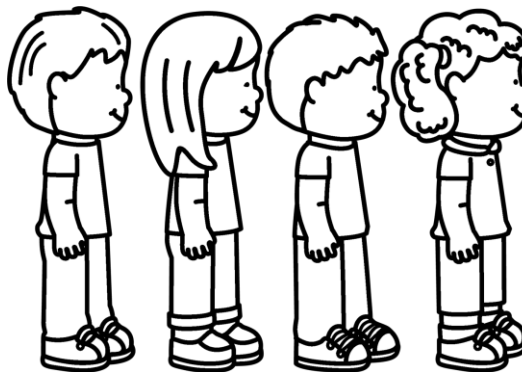

Tara West - Little Minds at Work

CVCE Encoding

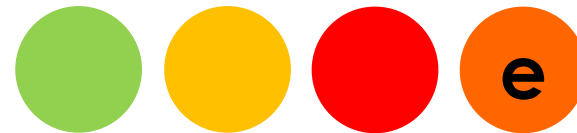
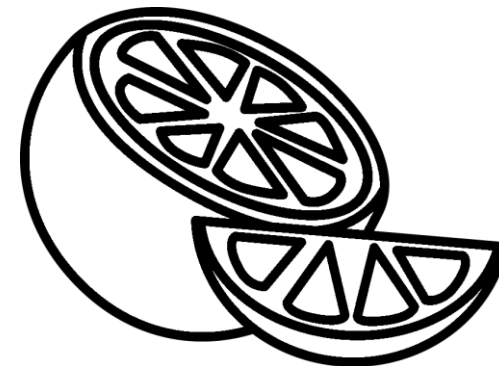

Tara West - Little Minds at Work

CVCE Encoding

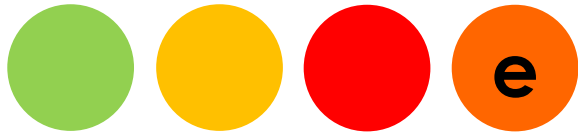

Tara West - Little Minds at Work

CVCE Encoding

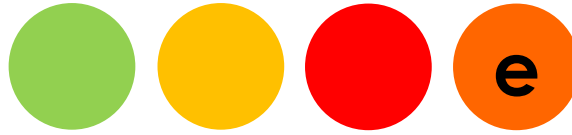

Tara West - Little Minds at Work

CVCE Encoding

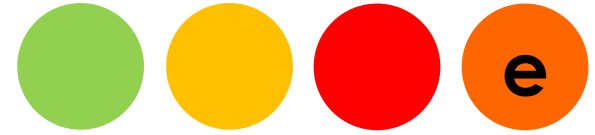
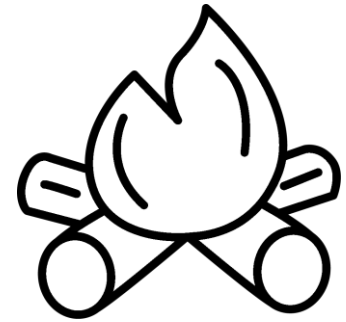

Tara West - Little Minds at Work

CVCE Encoding

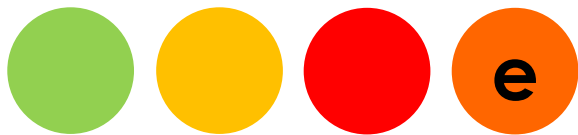
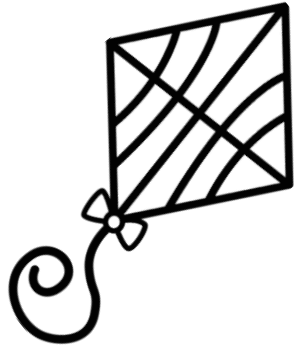

Tara West - Little Minds at Work

CVCE Encoding

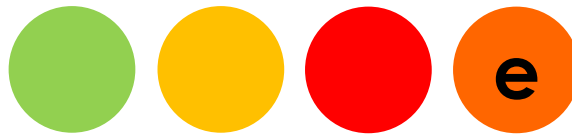

Tara West - Little Minds at Work

CVCE Encoding

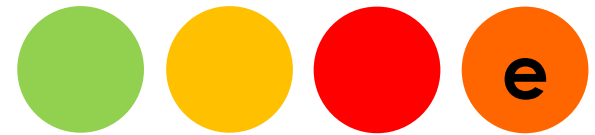
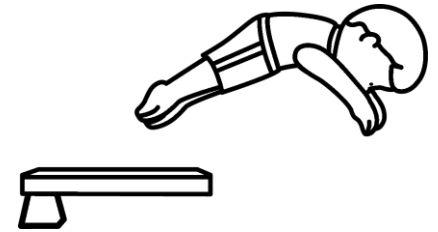

Tara West - Little Minds at Work

CVCE Encoding

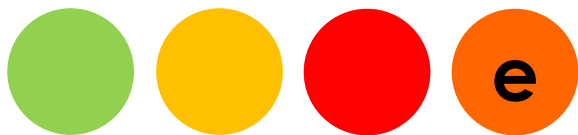
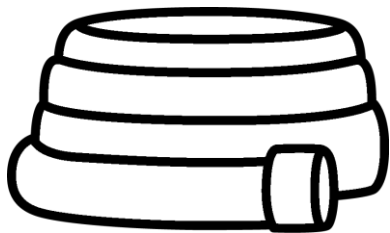

Tara West - Little Minds at Work

CVCE Encoding

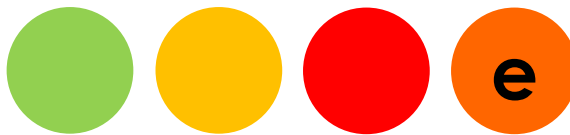
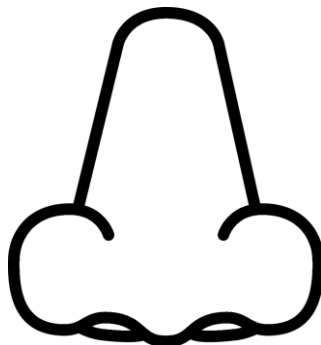

Tara West - Little Minds at Work

CVCE Encoding

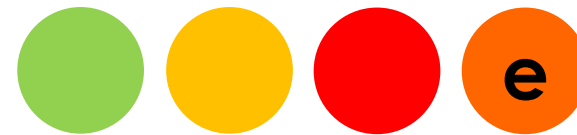
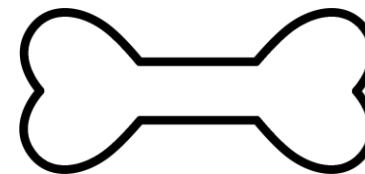

Tara West - Little Minds at Work

CVCE Encoding

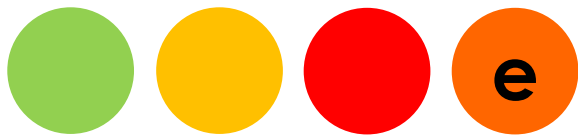

Tara West - Little Minds at Work

CVCE Encoding

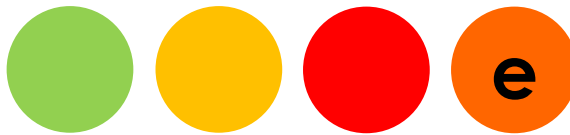
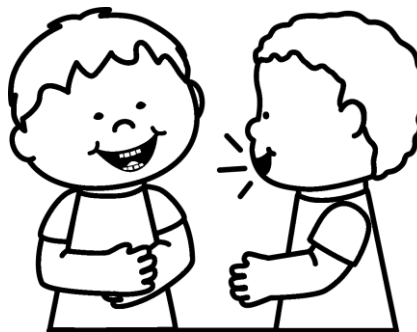

Tara West - Little Minds at Work

CVCE Encoding

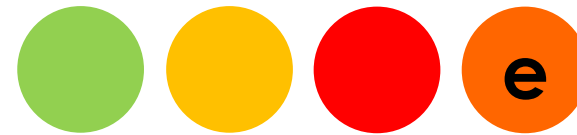

Tara West - Little Minds at Work

CVCE Encoding

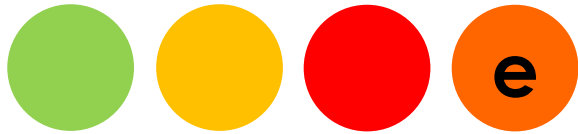

Tara West - Little Minds at Work

CVCE Encoding

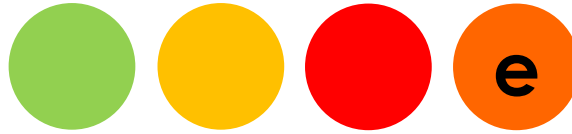

Tara West - Little Minds at Work

CVCE Encoding

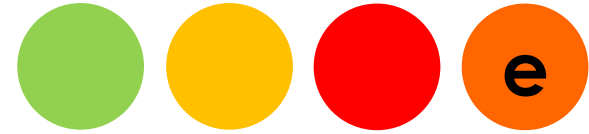
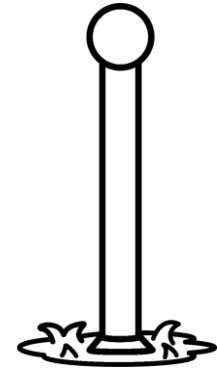

Tara West - Little Minds at Work

CVCE Encoding

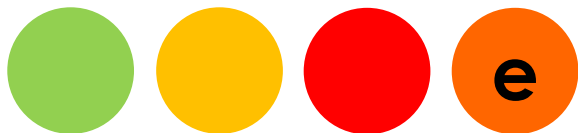
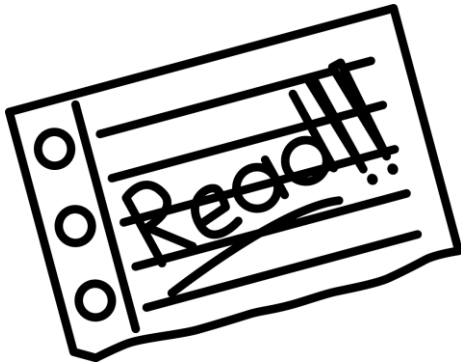

Tara West - Little Minds at Work

CVCE Encoding

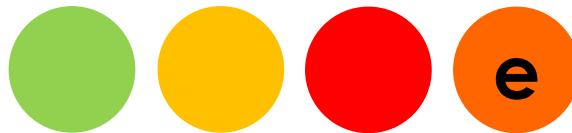
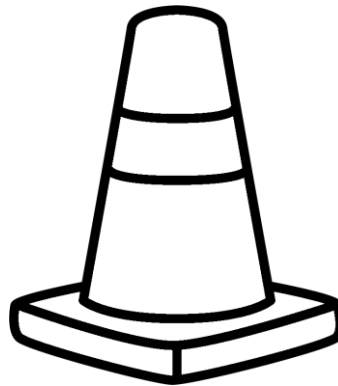

Tara West - Little Minds at Work

CVCE Encoding

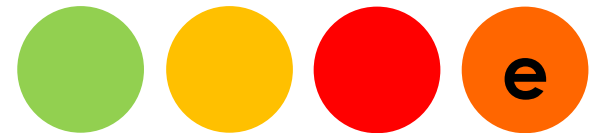

Tara West - Little Minds at Work

CVCE Encoding

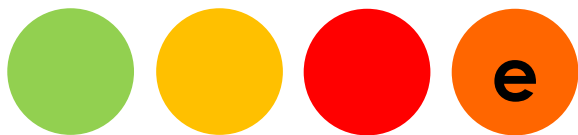
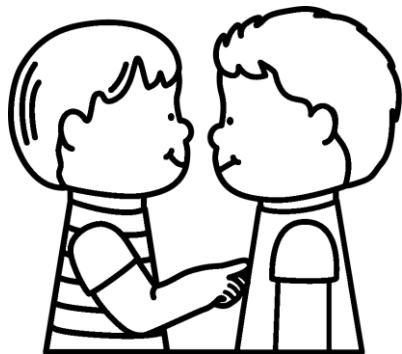

Tara West - Little Minds at Work

CVCE Encoding

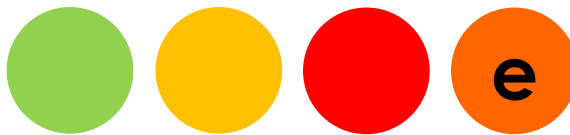
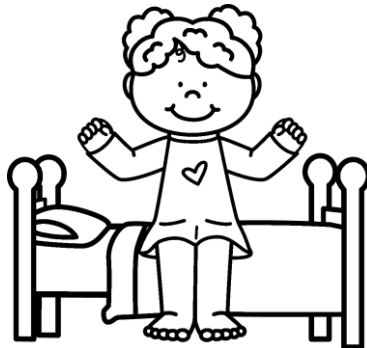

Tara West - Little Minds at Work

CVCE Encoding

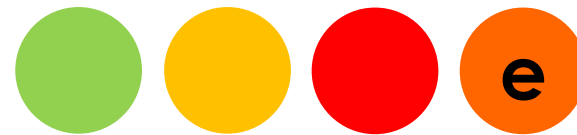
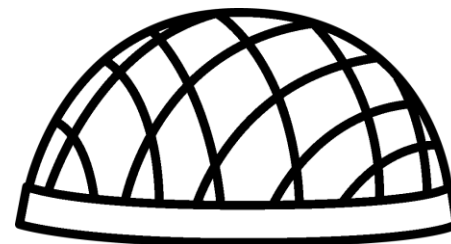

Tara West - Little Minds at Work

CVCE Encoding

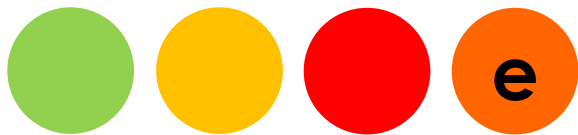
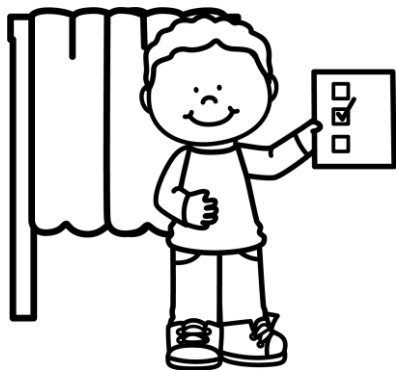

Tara West - Little Minds at Work

CVCE Encoding

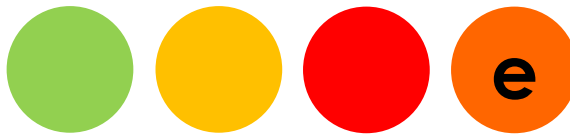
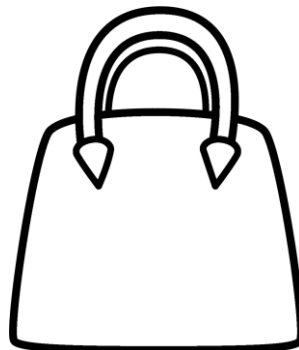

Tara West - Little Minds at Work

CVCE Encoding

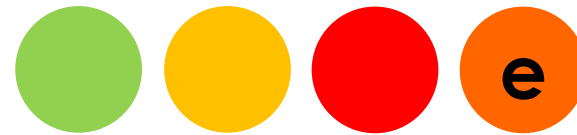
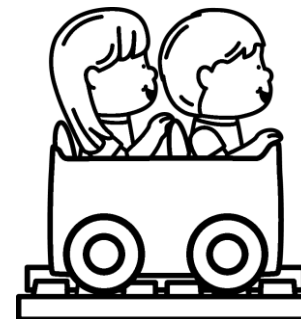

Tara West - Little Minds at Work

CVCE Encoding

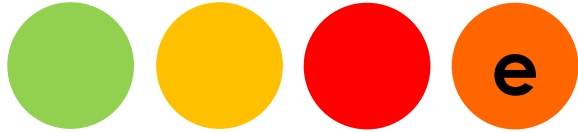
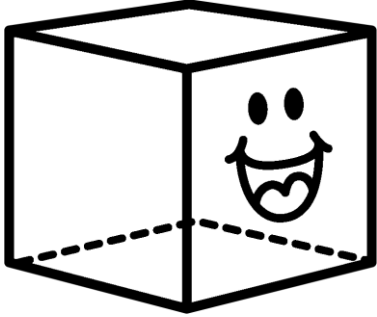

Tara West - Little Minds at Work

CVCE Encoding

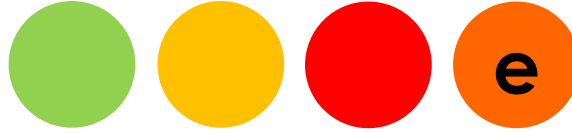
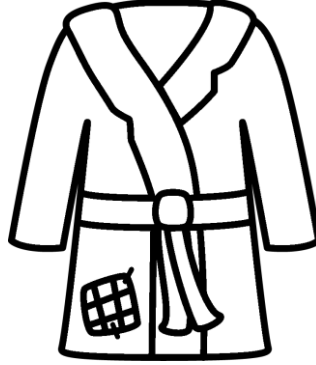

Tara West - Little Minds at Work

CVCE Encoding

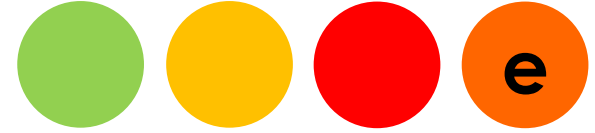

Tara West - Little Minds at Work

CVCE Encoding

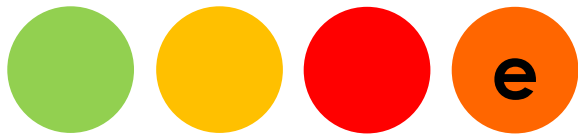
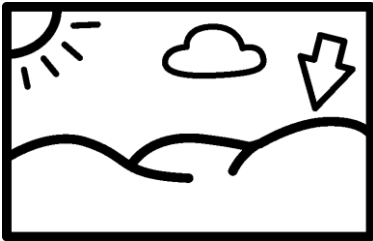

Tara West - Little Minds at Work

CVCE Encoding

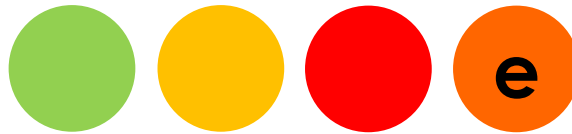
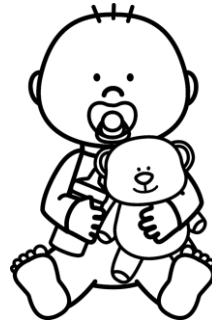

Tara West - Little Minds at Work

CVCE Encoding

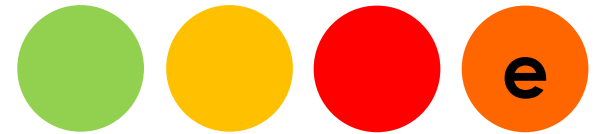

Tara West - Little Minds at Work

CVCE Encoding

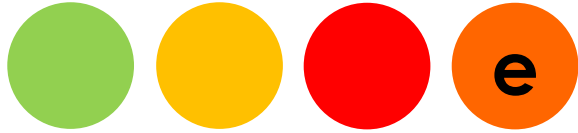

Tara West - Little Minds at Work

CVCE Encoding

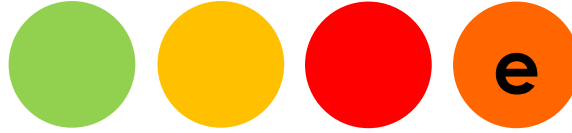
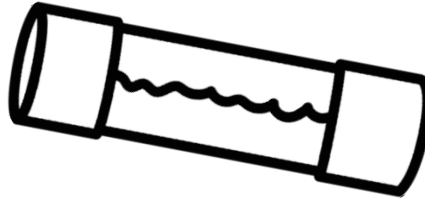

Tara West - Little Minds at Work

CVCE Encoding

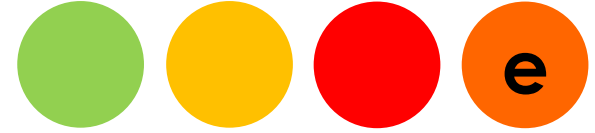

Tara West - Little Minds at Work

CVCE Encoding

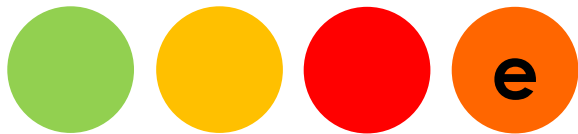

Tara West - Little Minds at Work

CVCE Encoding

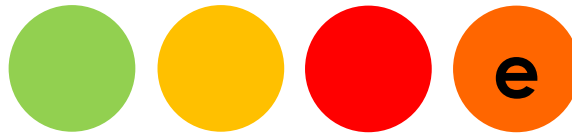
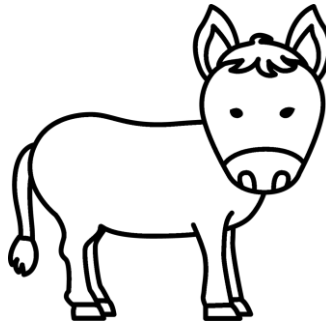

Tara West - Little Minds at Work

CVCE Encoding

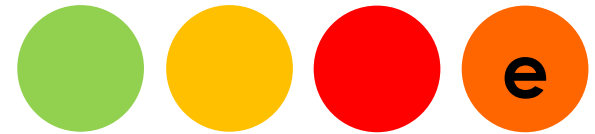

Tara West - Little Minds at Work

CVCE Encoding

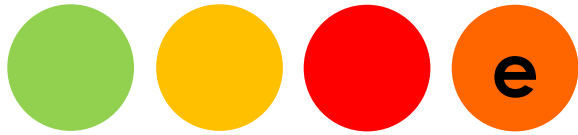
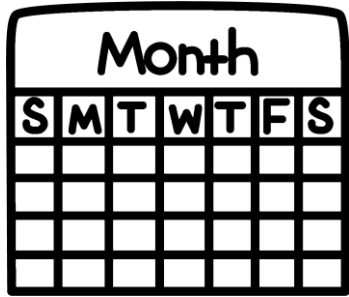

Tara West - Little Minds at Work

CVCE Encoding

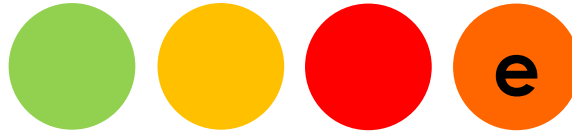

Tara West - Little Minds at Work

CVCE Encoding

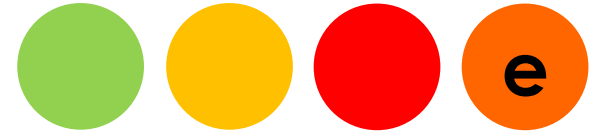
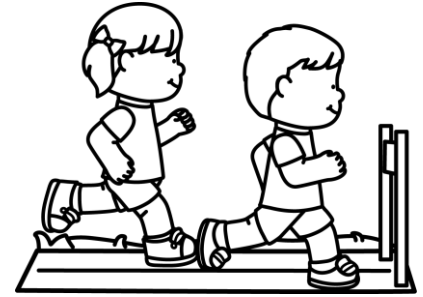

Tara West - Little Minds at Work

CVCE Encoding

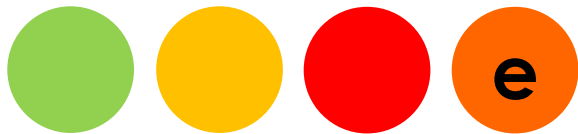
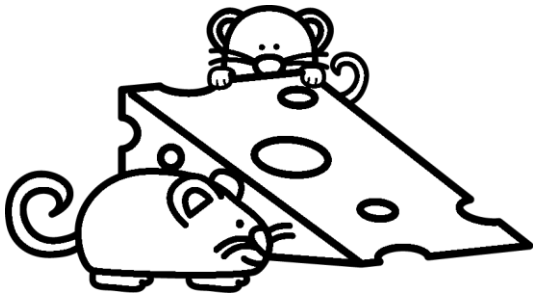

Tara West - Little Minds at Work

CVCE Encoding

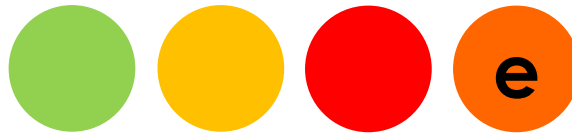

Tara West - Little Minds at Work

CVCE Encoding

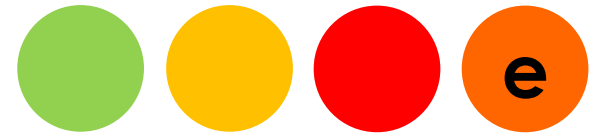

Tara West - Little Minds at Work

CVCE Encoding

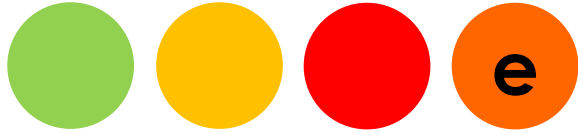
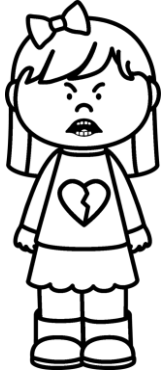

Tara West - Little Minds at Work

CVCE Encoding

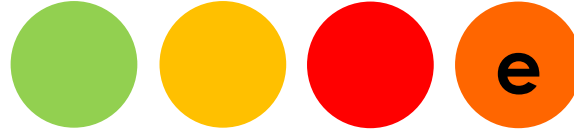
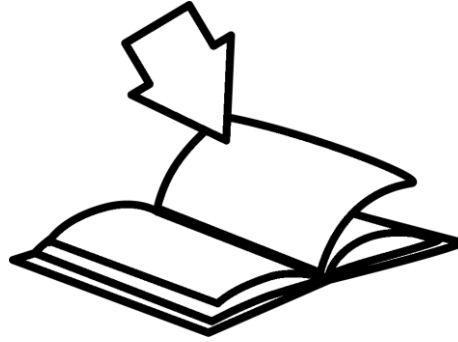

Tara West - Little Minds at Work

CVCE Encoding

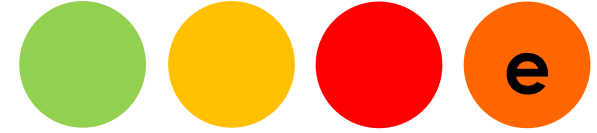
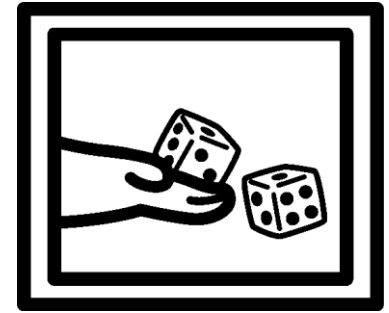

Tara West - Little Minds at Work

CVCE Encoding

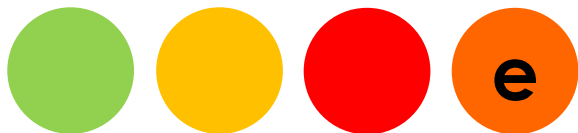
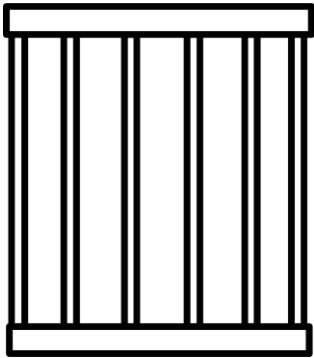

Tara West - Little Minds at Work

CVCE Encoding

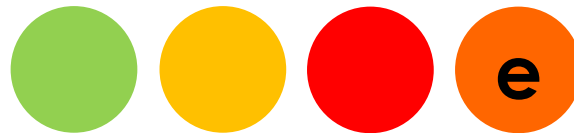
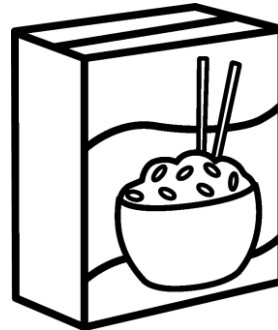

Tara West - Little Minds at Work

CVCE Encoding

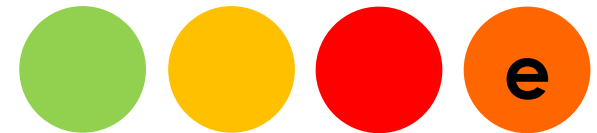
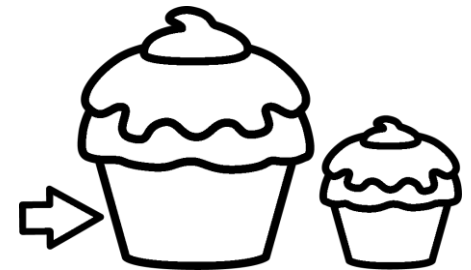

Tara West - Little Minds at Work

CVCC Encoding

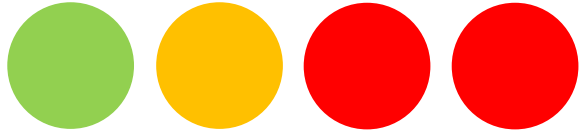
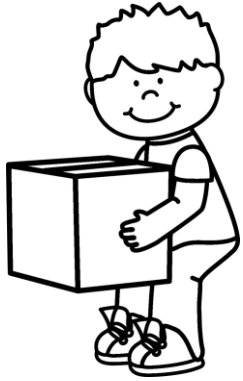

Tara West - Little Minds at Work

CVCC Encoding

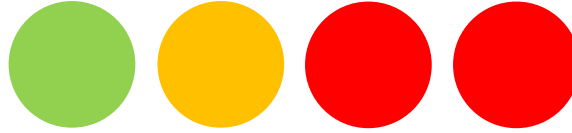
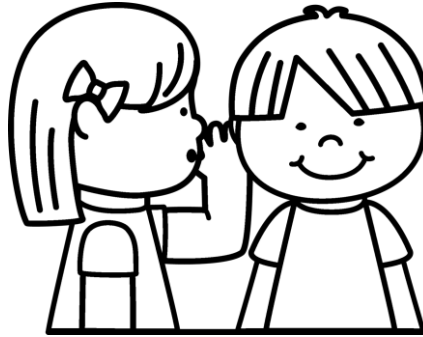

Tara West - Little Minds at Work

CVCC Encoding

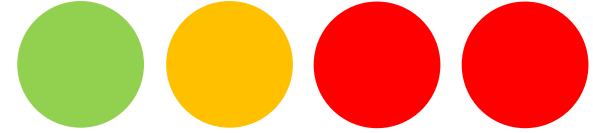
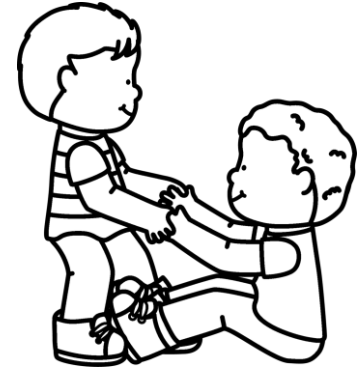

Tara West - Little Minds at Work

CVCC Encoding

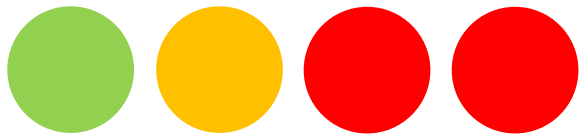
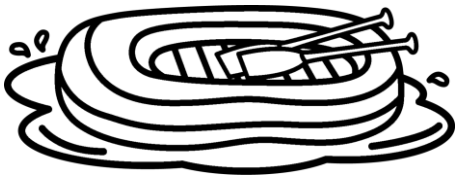

Tara West - Little Minds at Work

CVCC Encoding

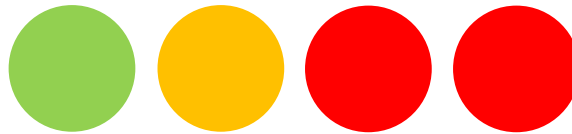

Tara West - Little Minds at Work

CVCC Encoding

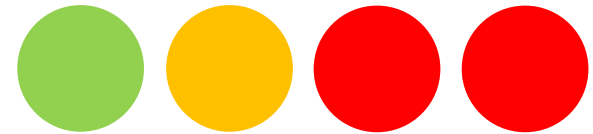

Tara West - Little Minds at Work

CVCC Encoding

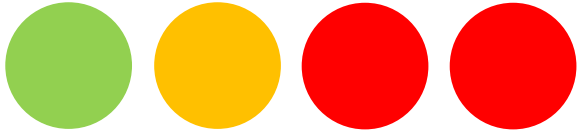

Tara West - Little Minds at Work

CVCC Encoding

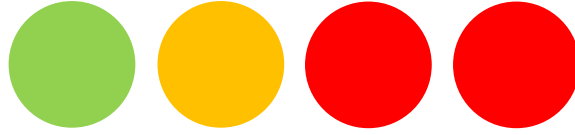
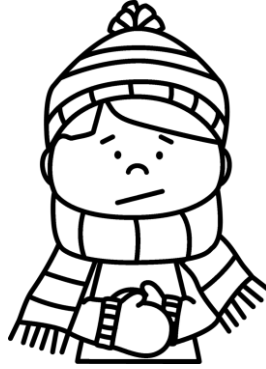

Tara West - Little Minds at Work

CVCC Encoding

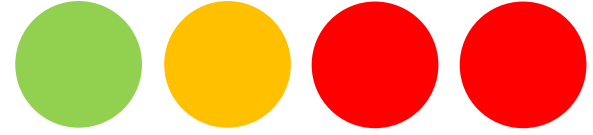

Tara West - Little Minds at Work

CVCC Encoding

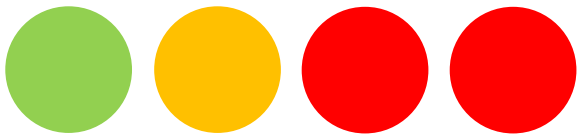
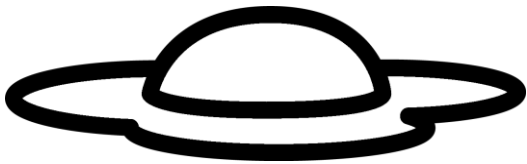

Tara West - Little Minds at Work

CVCC Encoding

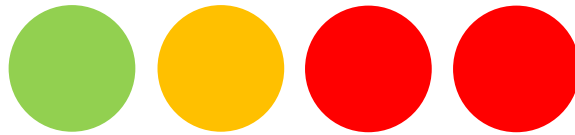

Tara West - Little Minds at Work

CVCC Encoding

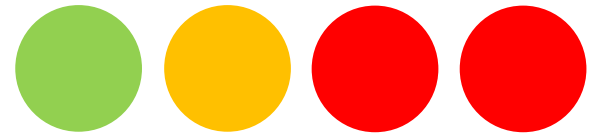
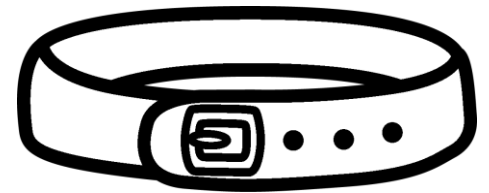

Tara West - Little Minds at Work

CVCC Encoding

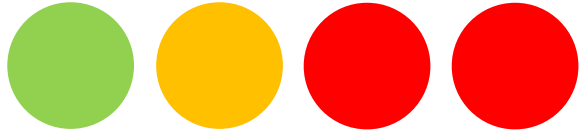

Tara West - Little Minds at Work

CVCC Encoding

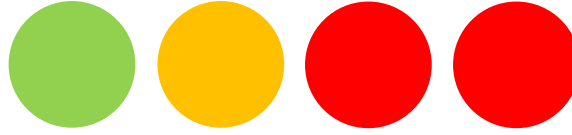
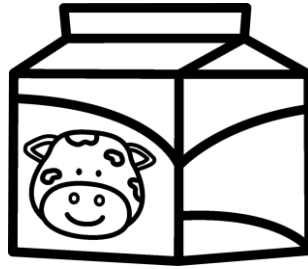

Tara West - Little Minds at Work

CVCC Encoding

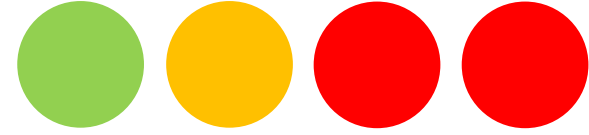

Tara West - Little Minds at Work

CVCC Encoding

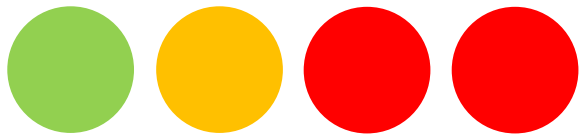
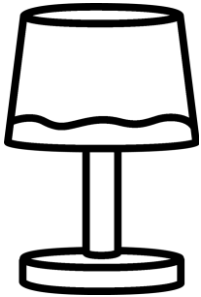

Tara West - Little Minds at Work

CVCC Encoding

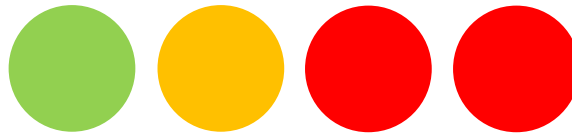
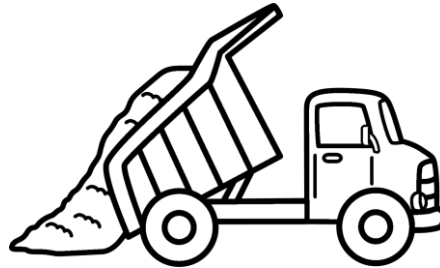

Tara West - Little Minds at Work

CVCC Encoding

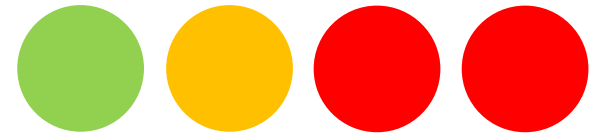
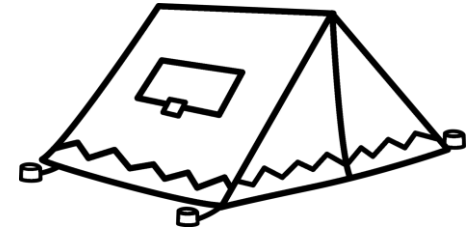

Tara West - Little Minds at Work

CVCC Encoding

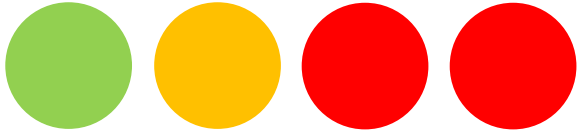
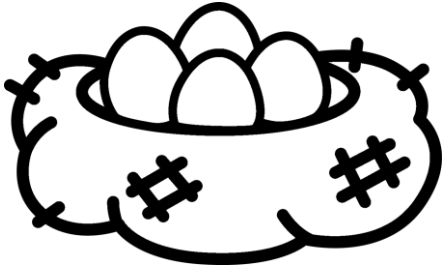

Tara West - Little Minds at Work

CVCC Encoding

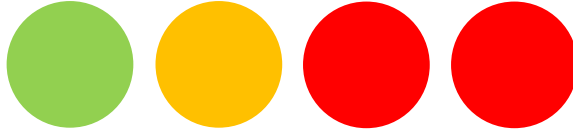

Tara West - Little Minds at Work

CVCC Encoding

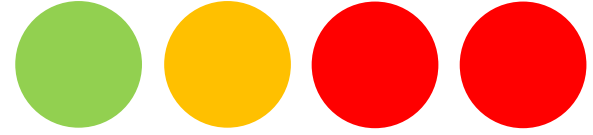
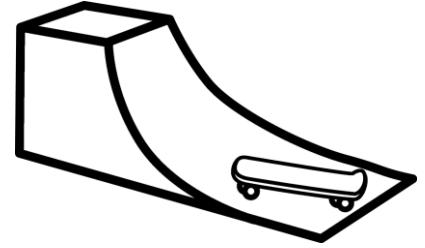

Tara West - Little Minds at Work

CVCC Encoding

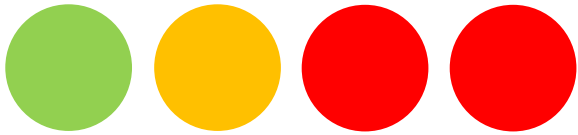
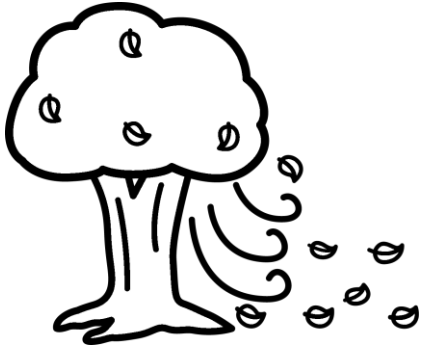

Tara West - Little Minds at Work

CVCC Encoding

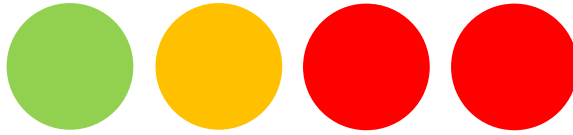
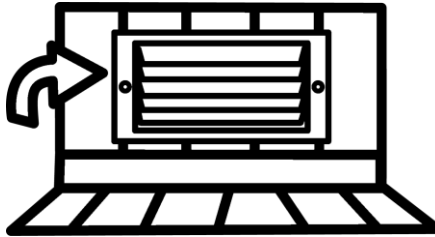

Tara West - Little Minds at Work

CVCC Encoding

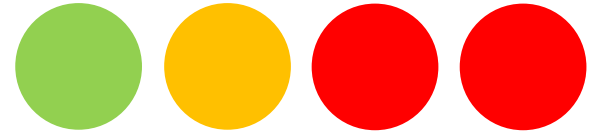

Tara West - Little Minds at Work

CVCC Encoding

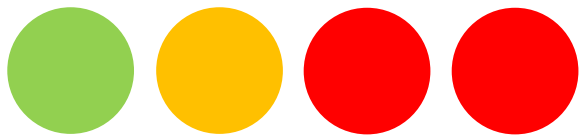

Tara West - Little Minds at Work

CVCC Encoding

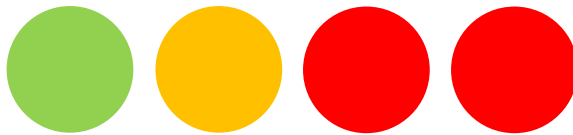

Tara West - Little Minds at Work

CVCC Encoding

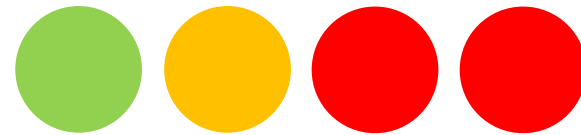

Tara West - Little Minds at Work

CVCC Encoding

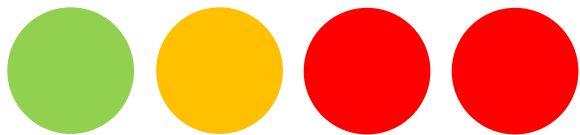

Tara West - Little Minds at Work

CVCC Encoding

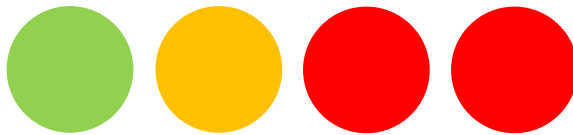
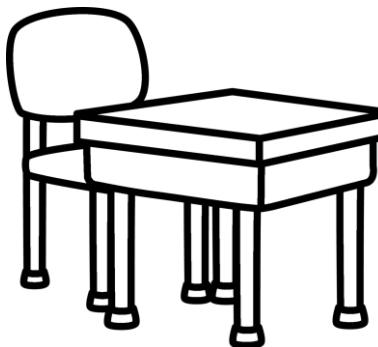

Tara West - Little Minds at Work

CVCC Encoding

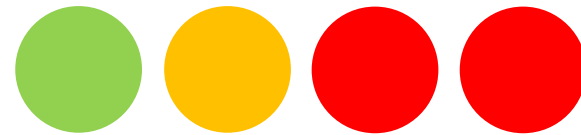

Tara West - Little Minds at Work

CVCC Encoding

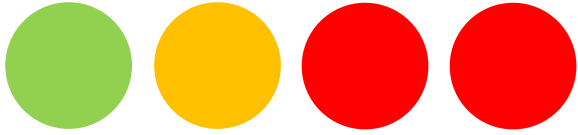
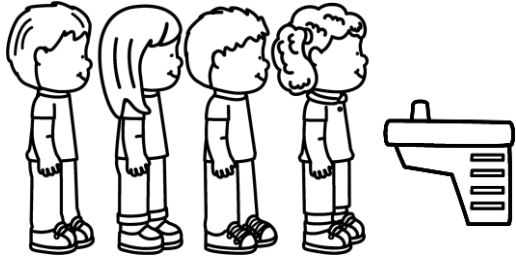

Tara West - Little Minds at Work

CVCC Encoding

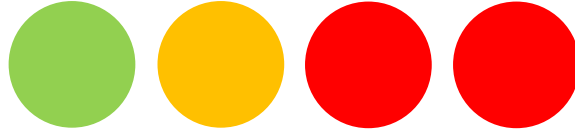
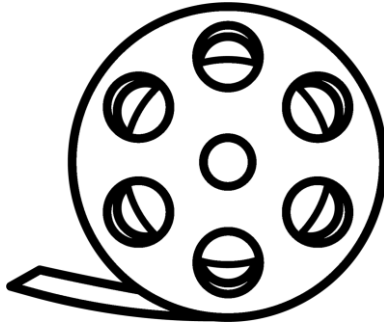

Tara West - Little Minds at Work

CVCC Encoding

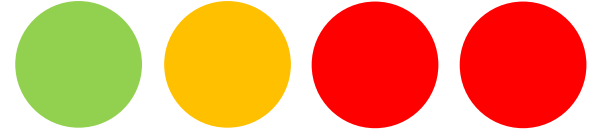
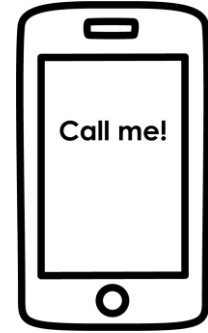

Tara West - Little Minds at Work

CVCC Encoding

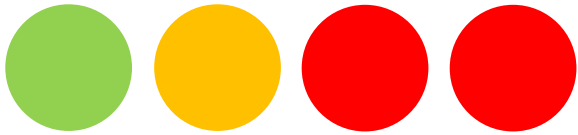
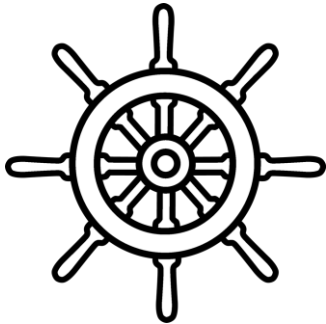

Tara West - Little Minds at Work

R-Controlled Encoding



Tara West - Little Minds at Work

R-Controlled Encoding

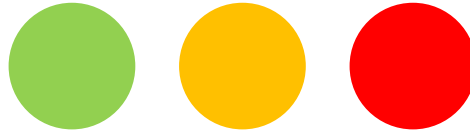
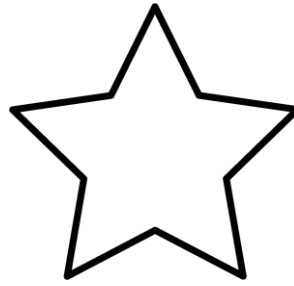

Tara West - Little Minds at Work

R-Controlled Encoding



Tara West - Little Minds at Work

R-Controlled Encoding

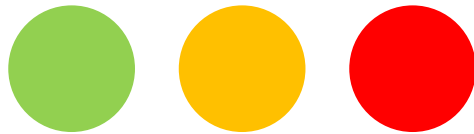
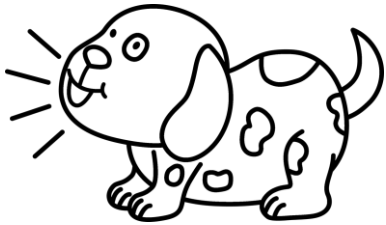

Tara West - Little Minds at Work

R-Controlled Encoding

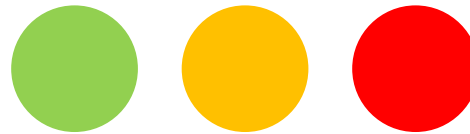
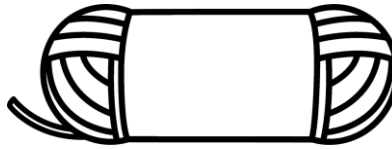

Tara West - Little Minds at Work

R-Controlled Encoding

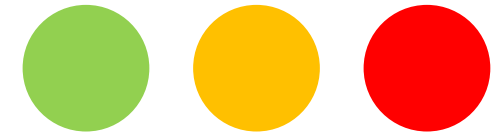
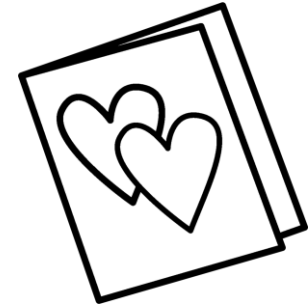

Tara West - Little Minds at Work

R-Controlled Encoding



Tara West - Little Minds at Work

R-Controlled Encoding

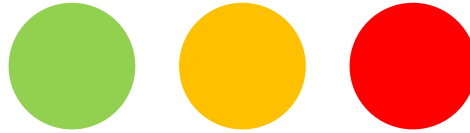

Tara West - Little Minds at Work

R-Controlled Encoding



Tara West - Little Minds at Work

R-Controlled Encoding

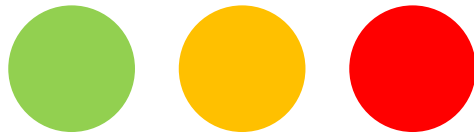
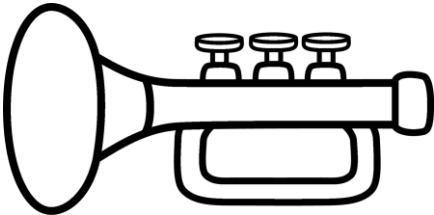

Tara West - Little Minds at Work

R-Controlled Encoding

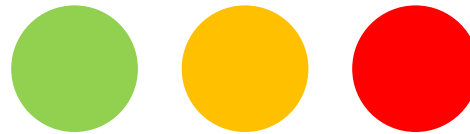
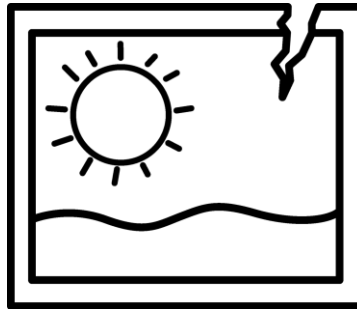

Tara West - Little Minds at Work

R-Controlled Encoding

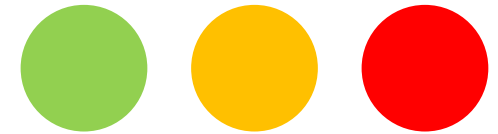
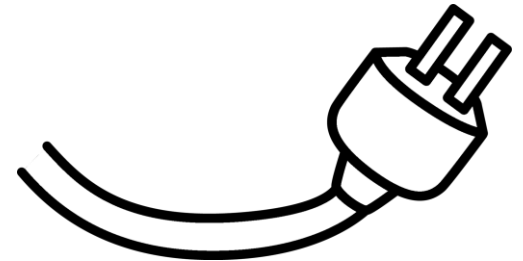

Tara West - Little Minds at Work

R-Controlled Encoding

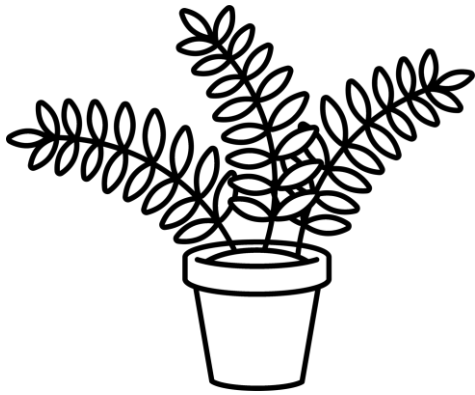

Tara West - Little Minds at Work

R-Controlled Encoding

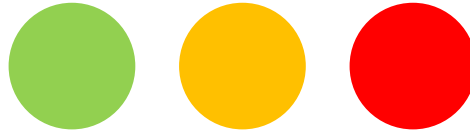

Tara West - Little Minds at Work

R-Controlled Encoding

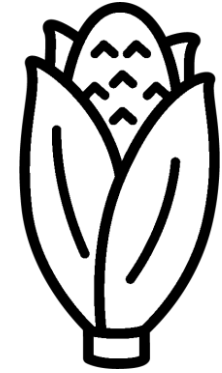

Tara West - Little Minds at Work

R-Controlled Encoding

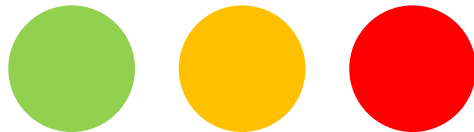
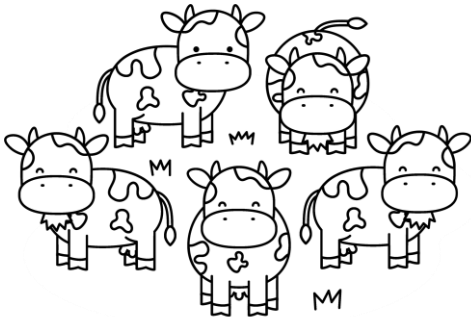

Tara West - Little Minds at Work

R-Controlled Encoding

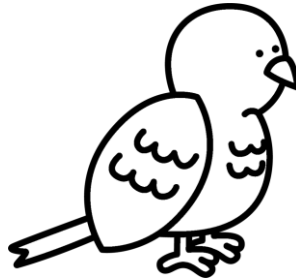

Tara West - Little Minds at Work

R-Controlled Encoding

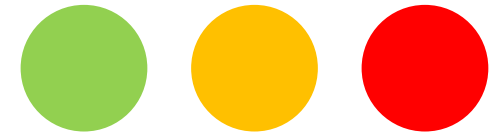

Tara West - Little Minds at Work

R-Controlled Encoding



Tara West - Little Minds at Work

R-Controlled Encoding

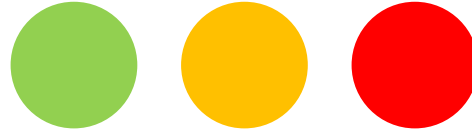
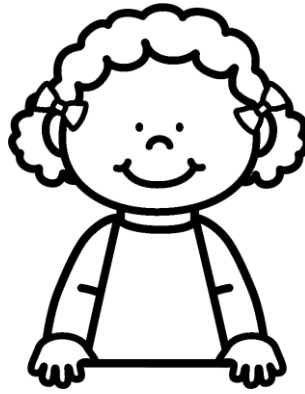

Tara West - Little Minds at Work

R-Controlled Encoding



Tara West - Little Minds at Work

R-Controlled Encoding

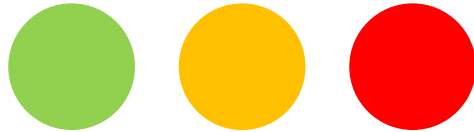
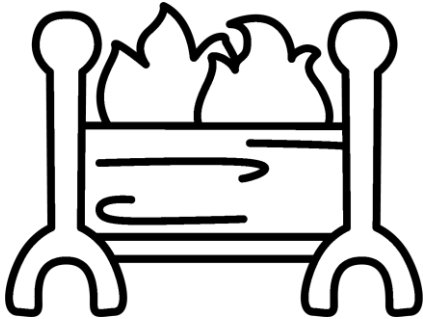

Tara West - Little Minds at Work

R-Controlled Encoding

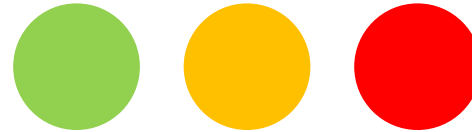
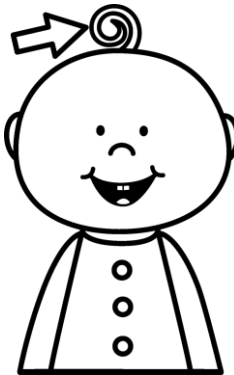

Tara West - Little Minds at Work

R-Controlled Encoding

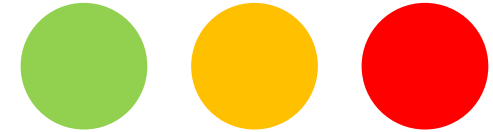

Tara West - Little Minds at Work

R-Controlled Encoding

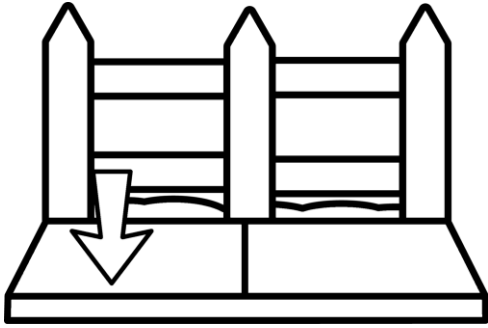

Tara West - Little Minds at Work

R-Controlled Encoding

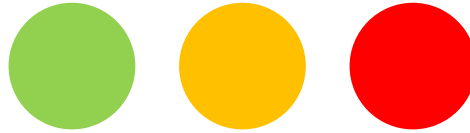
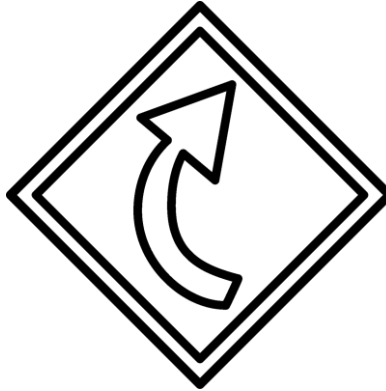

Tara West - Little Minds at Work

R-Controlled Encoding

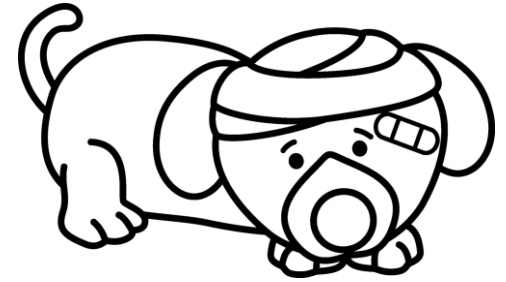

Tara West - Little Minds at Work

R-Controlled Encoding



Tara West - Little Minds at Work

Vowel Variants Encoding

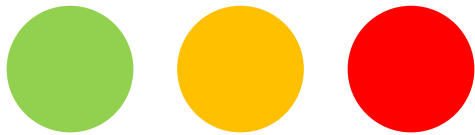

Tara West - Little Minds at Work

Vowel Variants Encoding

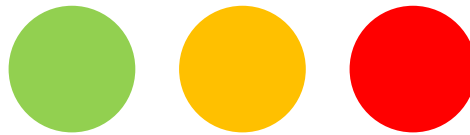
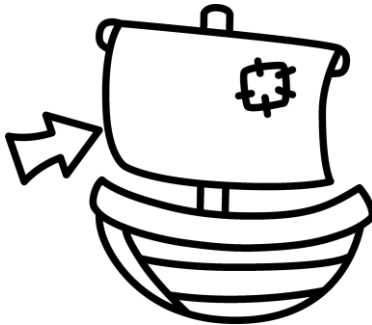

Tara West - Little Minds at Work

Vowel Variants Encoding

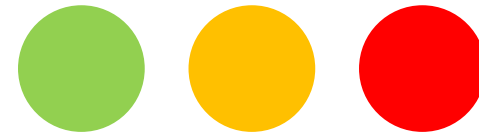

Tara West - Little Minds at Work

Vowel Variants Encoding

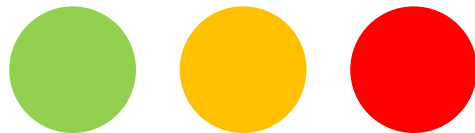
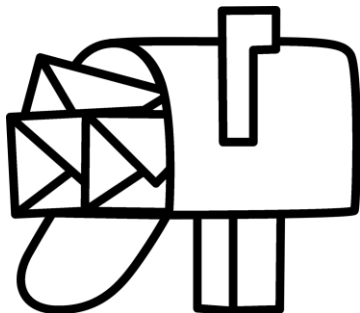

Tara West - Little Minds at Work

Vowel Variants Encoding

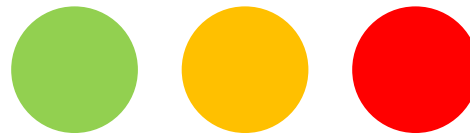
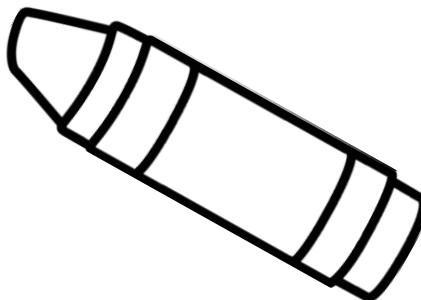

Tara West - Little Minds at Work

Vowel Variants Encoding

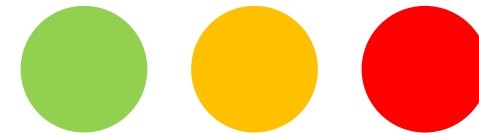
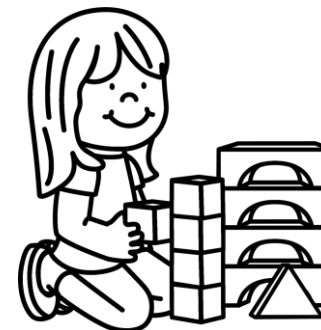

Tara West - Little Minds at Work

Vowel Variants Encoding

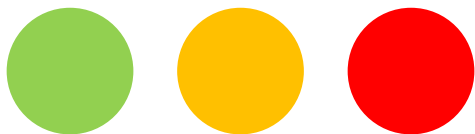
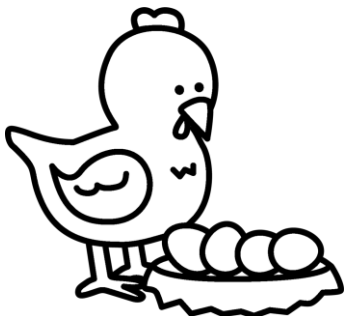

Tara West - Little Minds at Work

Vowel Variants Encoding

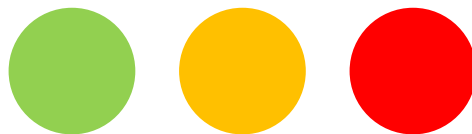

Tara West - Little Minds at Work

Vowel Variants Encoding

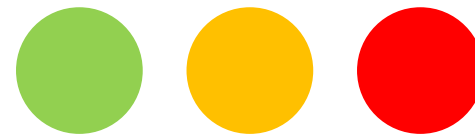
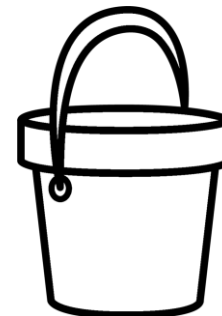

Tara West - Little Minds at Work

Vowel Variants Encoding

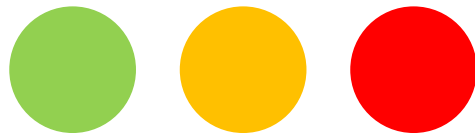

Tara West - Little Minds at Work

Vowel Variants Encoding

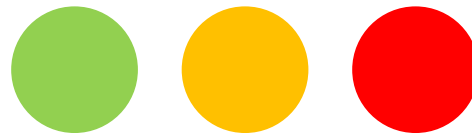
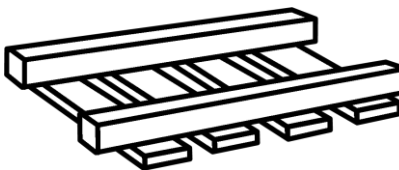

Tara West - Little Minds at Work

Vowel Variants Encoding

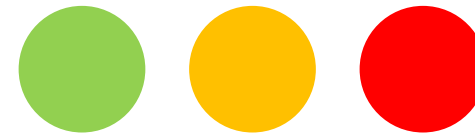
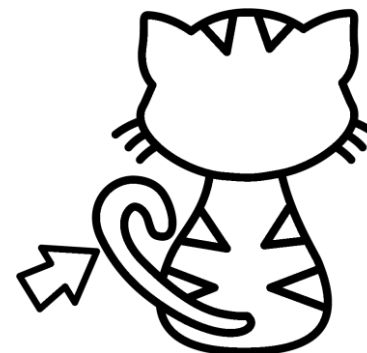

Tara West - Little Minds at Work

Vowel Variants Encoding

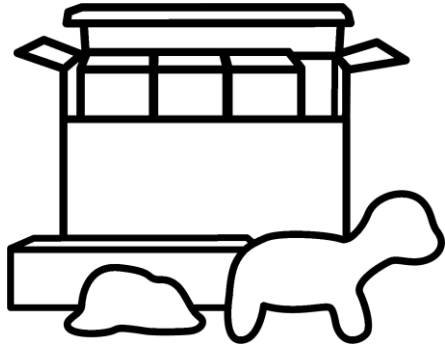

Tara West - Little Minds at Work

Vowel Variants Encoding

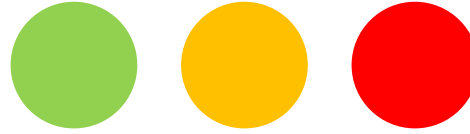

Tara West - Little Minds at Work

Vowel Variants Encoding

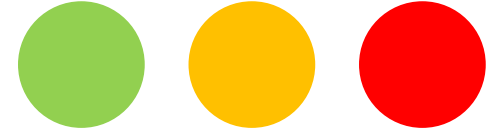
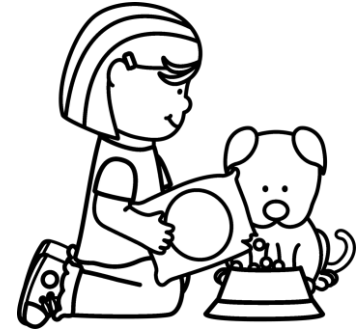

Tara West - Little Minds at Work

Vowel Variants Encoding

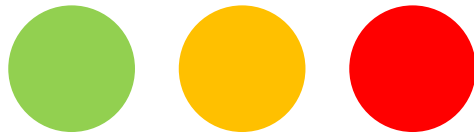
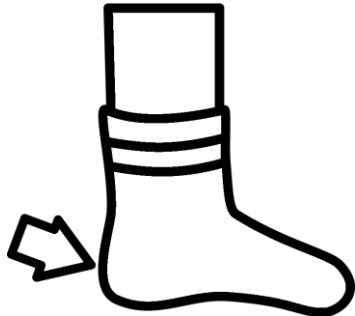

Tara West - Little Minds at Work

Vowel Variants Encoding

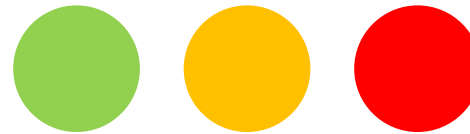

Tara West - Little Minds at Work

Vowel Variants Encoding

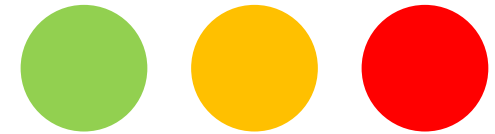
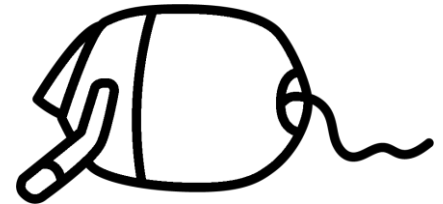

Tara West - Little Minds at Work

Vowel Variants Encoding



Tara West - Little Minds at Work

Vowel Variants Encoding

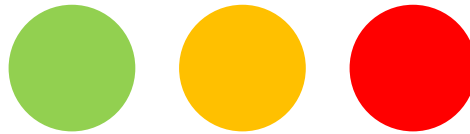

Tara West - Little Minds at Work

Vowel Variants Encoding

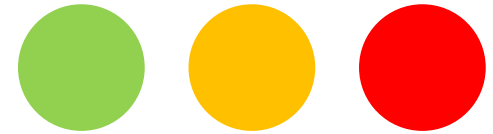
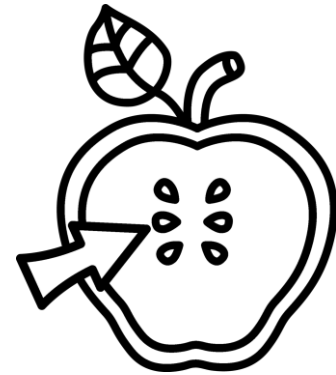

Tara West - Little Minds at Work

Vowel Variants Encoding

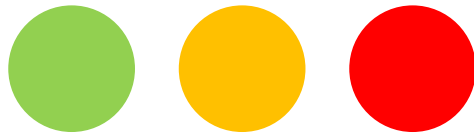
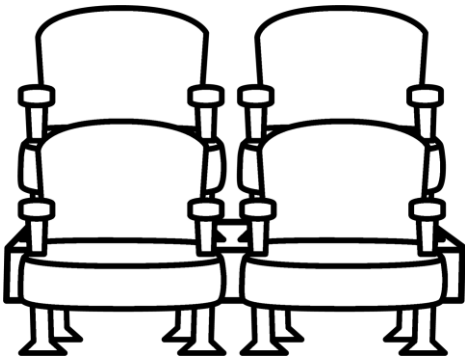

Tara West - Little Minds at Work

Vowel Variants Encoding

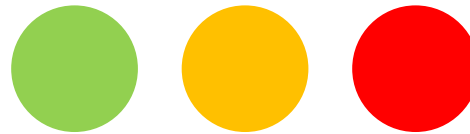
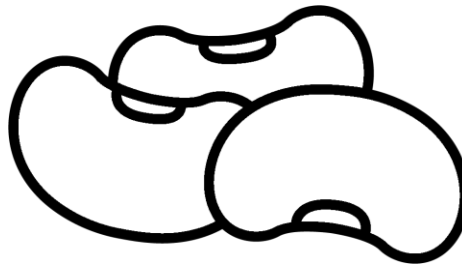

Tara West - Little Minds at Work

Vowel Variants Encoding

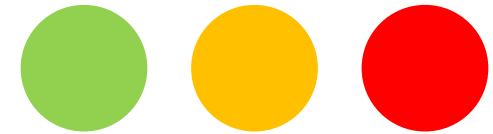
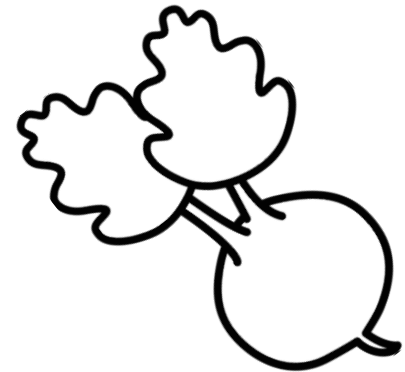

Tara West - Little Minds at Work

Vowel Variants Encoding

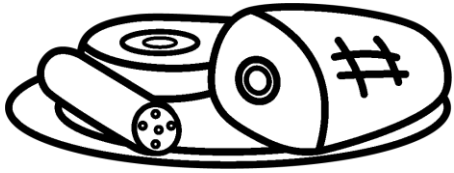

Tara West - Little Minds at Work

Vowel Variants Encoding

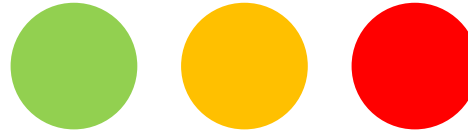
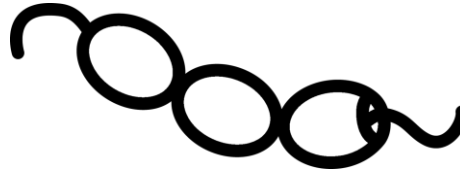

Tara West - Little Minds at Work

Vowel Variants Encoding

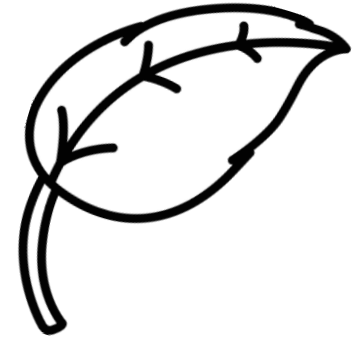

Tara West - Little Minds at Work

Vowel Variants Encoding

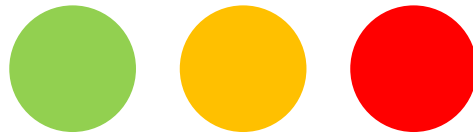
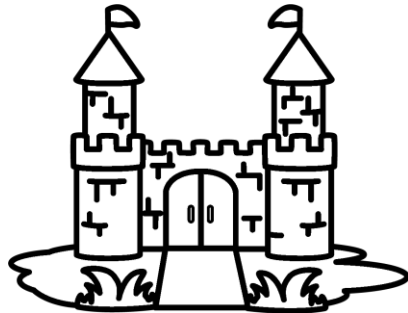

Tara West - Little Minds at Work

Vowel Variants Encoding

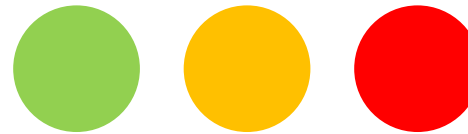
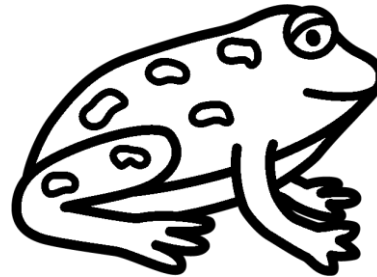

Tara West - Little Minds at Work

Vowel Variants Encoding

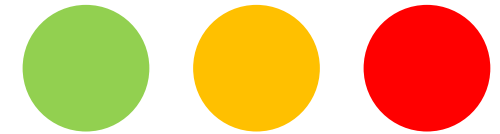

Tara West - Little Minds at Work

Vowel Variants Encoding

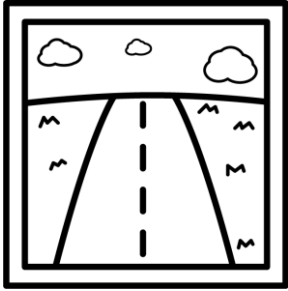

Tara West - Little Minds at Work

Vowel Variants Encoding

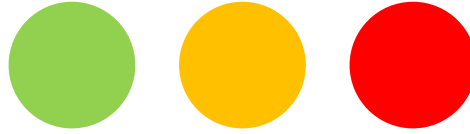
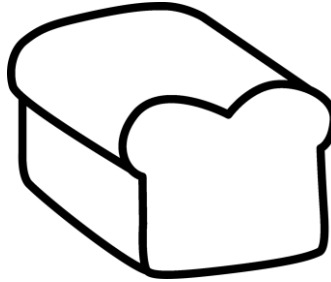

Tara West - Little Minds at Work

Vowel Variants Encoding

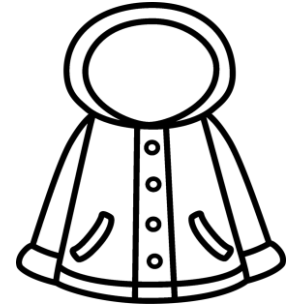

Tara West - Little Minds at Work

Vowel Variants Encoding

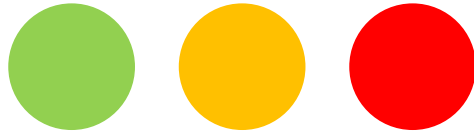

Tara West - Little Minds at Work

Vowel Variants Encoding

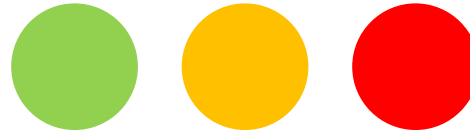
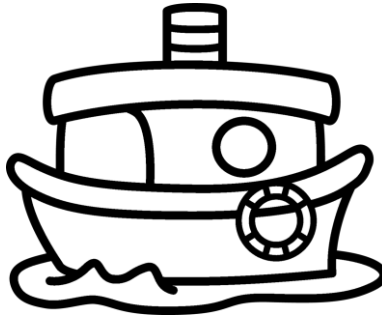

Tara West - Little Minds at Work

Vowel Variants Encoding

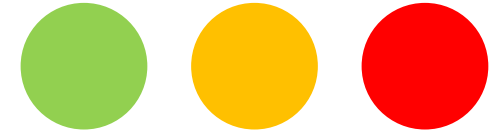
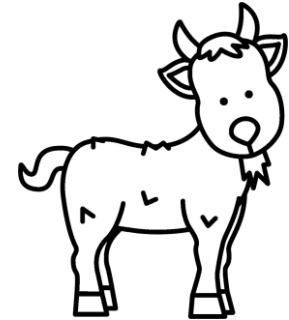

Tara West - Little Minds at Work

Vowel Variants Encoding



Tara West - Little Minds at Work

Vowel Variants Encoding

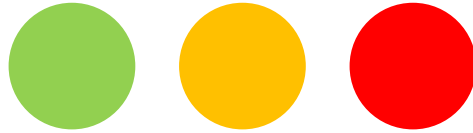
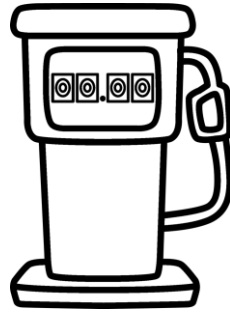

Tara West - Little Minds at Work

Vowel Variants Encoding



Tara West - Little Minds at Work

Vowel Variants Encoding

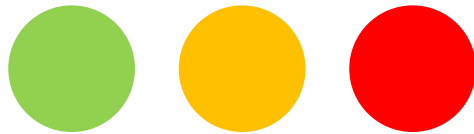

Tara West - Little Minds at Work

Vowel Variants Encoding

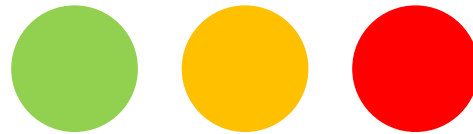
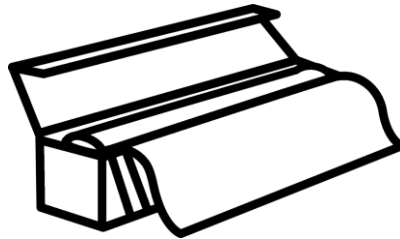

Tara West - Little Minds at Work

Vowel Variants Encoding

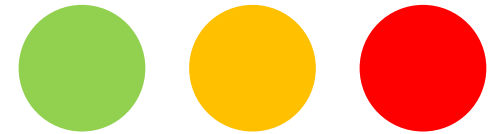
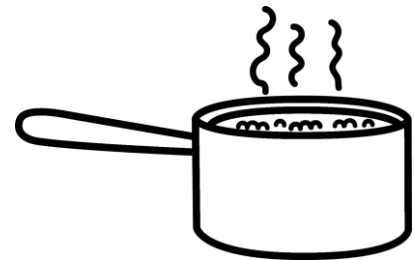

Tara West - Little Minds at Work

Vowel Variants Encoding

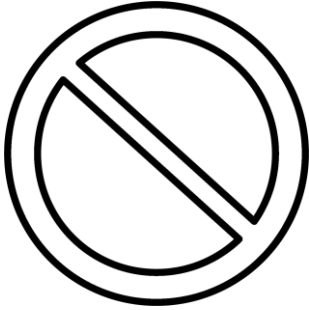

Tara West - Little Minds at Work

Vowel Variants Encoding

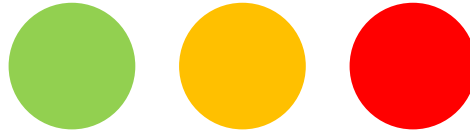
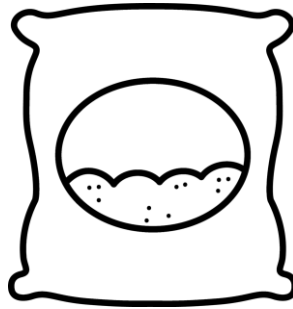

Tara West - Little Minds at Work

Vowel Variants Encoding



Tara West - Little Minds at Work

Vowel Variants Encoding

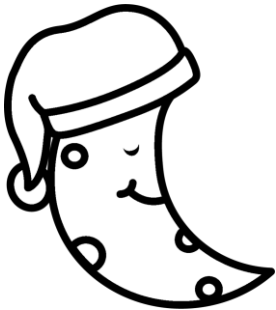

Tara West - Little Minds at Work

Vowel Variants Encoding

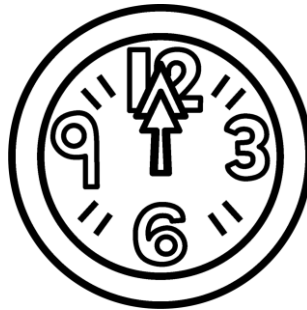

Tara West - Little Minds at Work

Vowel Variants Encoding

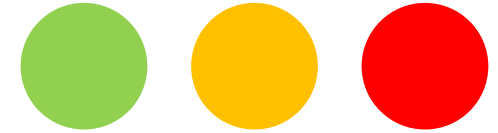
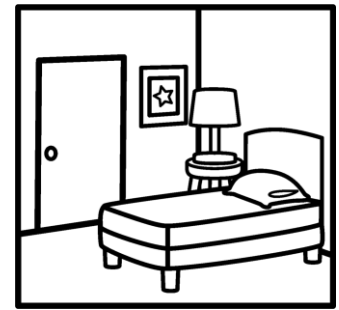

Tara West - Little Minds at Work

Vowel Variants Encoding



Tara West - Little Minds at Work

Vowel Variants Encoding

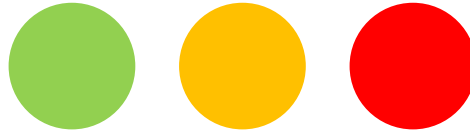
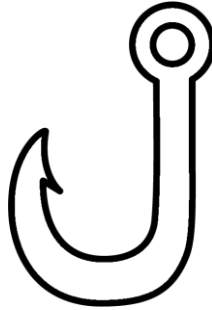

Tara West - Little Minds at Work

Vowel Variants Encoding

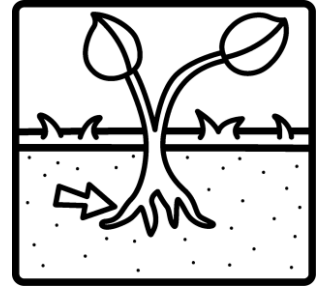

Tara West - Little Minds at Work

Vowel Variants Encoding

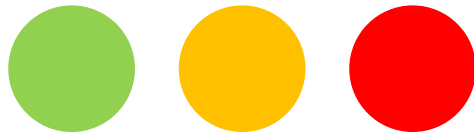

Tara West - Little Minds at Work

Vowel Variants Encoding

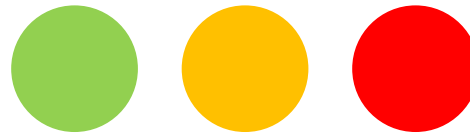
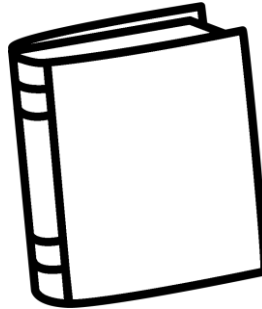

Tara West - Little Minds at Work

Vowel Variants Encoding

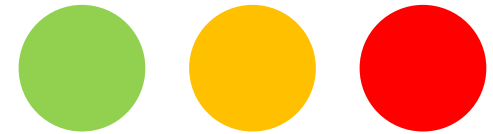
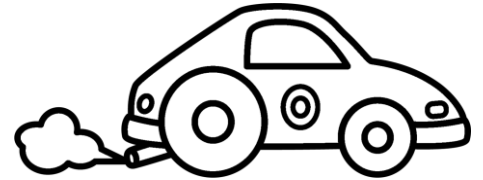

Tara West - Little Minds at Work

Vowel Variants Encoding

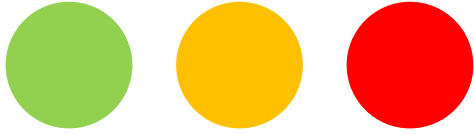

Tara West - Little Minds at Work

Vowel Variants Encoding

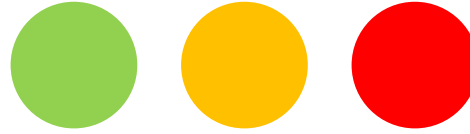
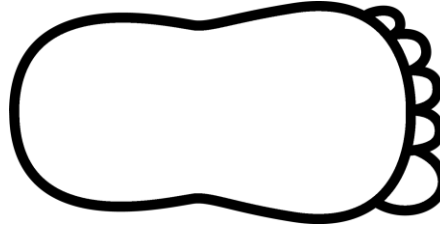

Tara West - Little Minds at Work

Vowel Variants Encoding



Tara West - Little Minds at Work

Vowel Variants Encoding

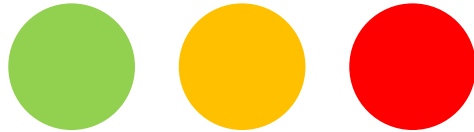
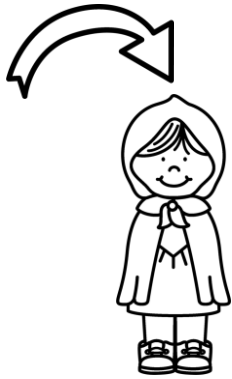

Tara West - Little Minds at Work

CVC Encoding



mat

Tara West - Little Minds at Work

CVC Encoding

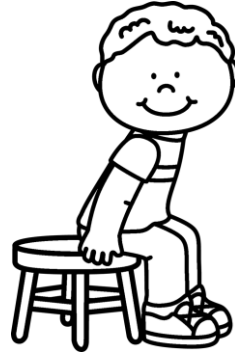

sat

Tara West - Little Minds at Work

CVC Encoding

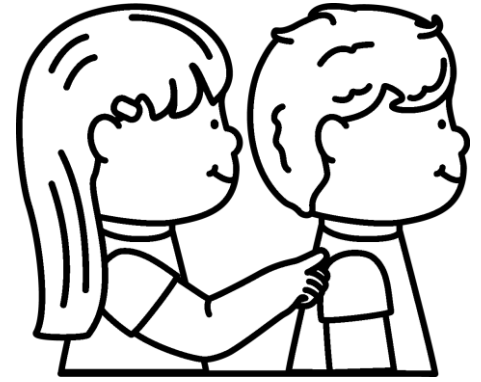

tap

Tara West - Little Minds at Work

CVC Encoding

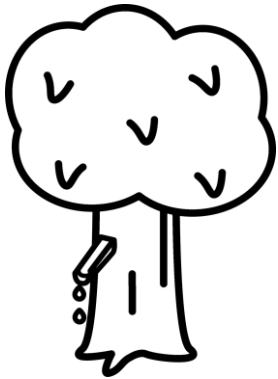

sap

Tara West - Little Minds at Work

CVC Encoding



pat

Tara West - Little Minds at Work

CVC Encoding

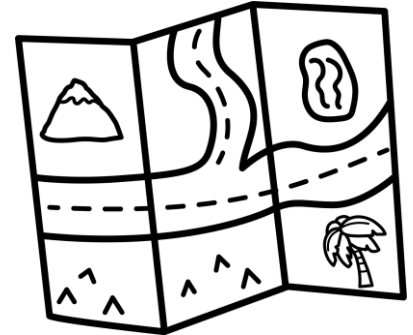

map

Tara West - Little Minds at Work

CVC Encoding

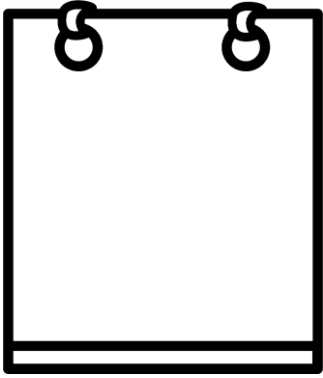

pad

Tara West - Little Minds at Work

CVC Encoding

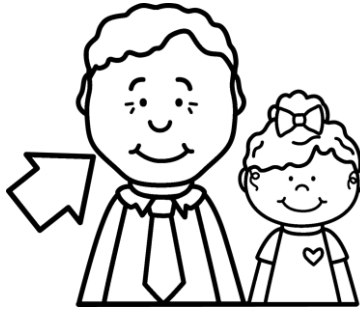

dad

Tara West - Little Minds at Work

CVC Encoding



mad

Tara West - Little Minds at Work

CVC Encoding



sad

Tara West - Little Minds at Work

CVC Encoding



sip

Tara West - Little Minds at Work

CVC Encoding



fit

Tara West - Little Minds at Work

CVC Encoding

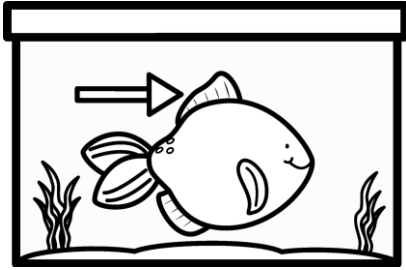

fin

Tara West - Little Minds at Work

CVC Encoding

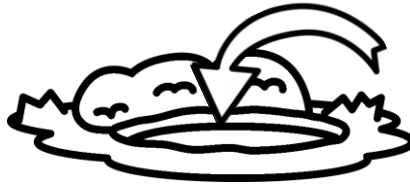

pit

Tara West - Little Minds at Work

CVC Encoding

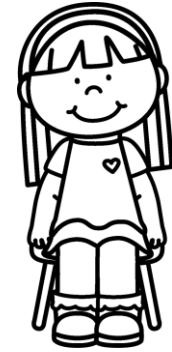

sit

Tara West - Little Minds at Work

CVC Encoding

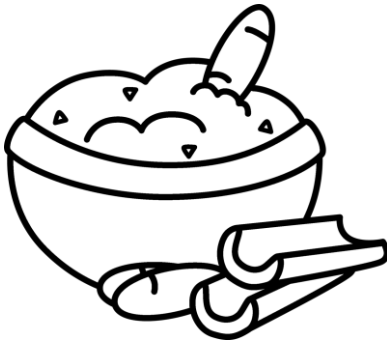

dip

Tara West - Little Minds at Work

CVC Encoding

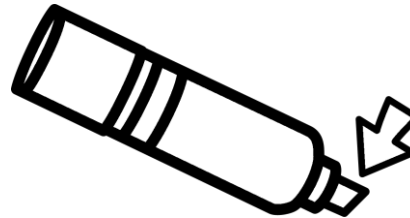

tip

Tara West - Little Minds at Work

CVC Encoding

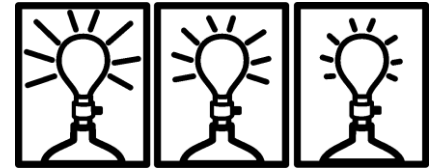

dim

Tara West - Little Minds at Work

CVC Encoding

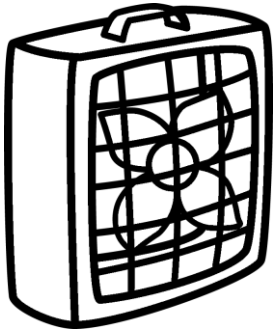

fan

Tara West - Little Minds at Work

CVC Encoding



tin

Tara West - Little Minds at Work

CVC Encoding



man

Tara West - Little Minds at Work

CVC Encoding

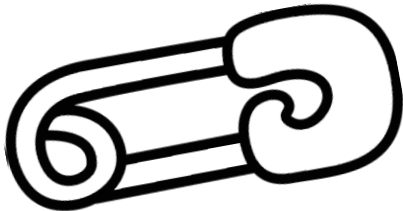

pin

Tara West - Little Minds at Work

CVC Encoding

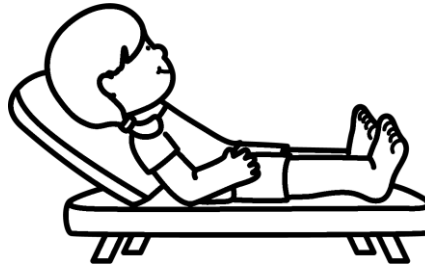

tan

Tara West - Little Minds at Work

CVC Encoding



nap

Tara West - Little Minds at Work

CVC Encoding

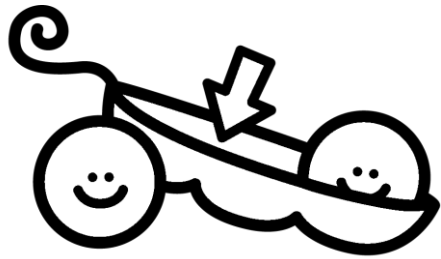

pod

Tara West - Little Minds at Work

CVC Encoding



nod

Tara West - Little Minds at Work

CVC Encoding



pan

Tara West - Little Minds at Work

CVC Encoding

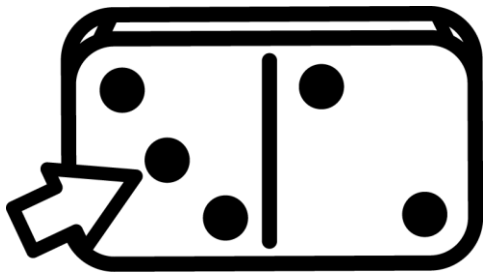

dot

Tara West - Little Minds at Work

CVC Encoding

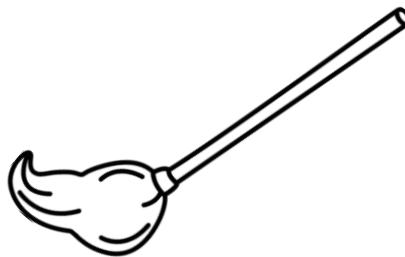

mop

Tara West - Little Minds at Work

CVC Encoding

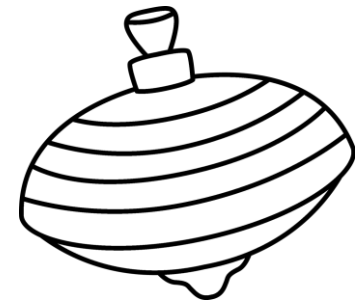

top

Tara West - Little Minds at Work

CVC Encoding

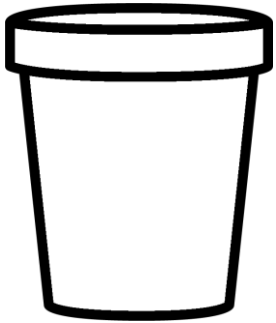

pot

Tara West - Little Minds at Work

CVC Encoding

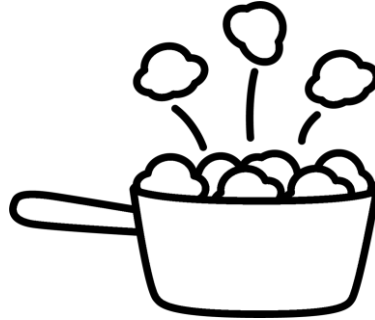

pop

Tara West - Little Minds at Work

CVC Encoding

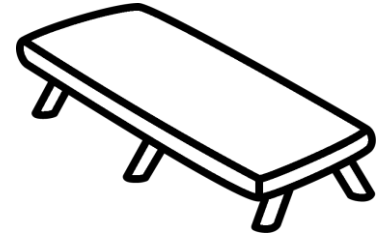

cot

Tara West - Little Minds at Work

CVC Encoding



cap

Tara West - Little Minds at Work

CVC Encoding

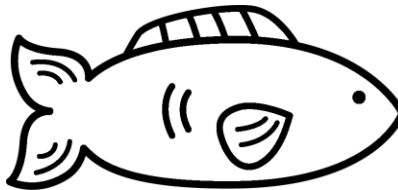

cod

Tara West - Little Minds at Work

CVC Encoding



cop

Tara West - Little Minds at Work

CVC Encoding



kit

Tara West - Little Minds at Work

CVC Encoding

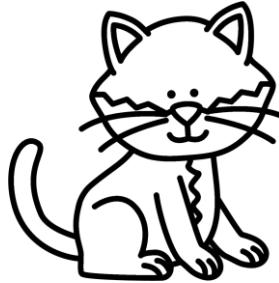

cat

Tara West - Little Minds at Work

CVC Encoding

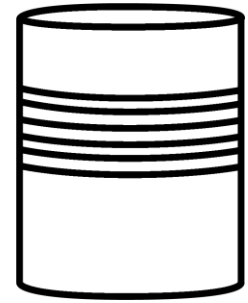

can

Tara West - Little Minds at Work

CVC Encoding

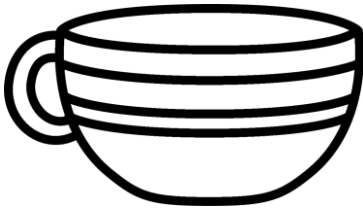

cup

Tara West - Little Minds at Work

CVC Encoding

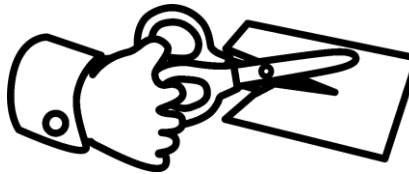

cut

Tara West - Little Minds at Work

CVC Encoding

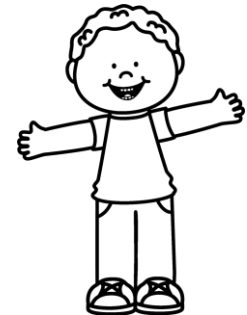

kid

Tara West - Little Minds at Work

CVC Encoding

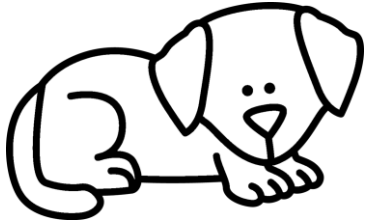

pup

Tara West - Little Minds at Work

CVC Encoding



fun

Tara West - Little Minds at Work

CVC Encoding

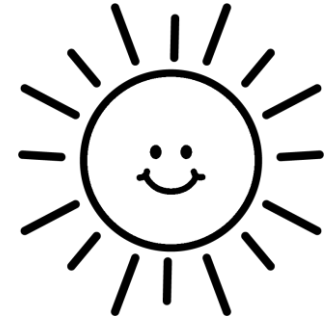

sun

Tara West - Little Minds at Work

CVC Encoding

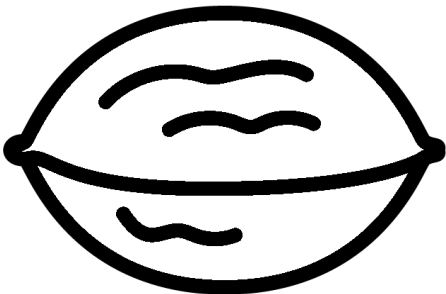

nut

Tara West - Little Minds at Work

CVC Encoding

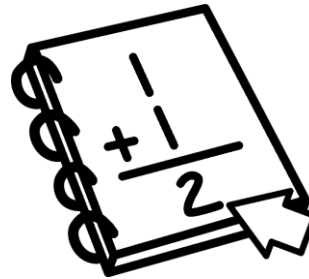

sum

Tara West - Little Minds at Work

CVC Encoding

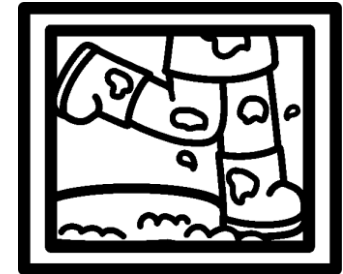

mud

Tara West - Little Minds at Work

CVC Encoding



vet

Tara West - Little Minds at Work

CVC Encoding



fix

Tara West - Little Minds at Work

CVC Encoding

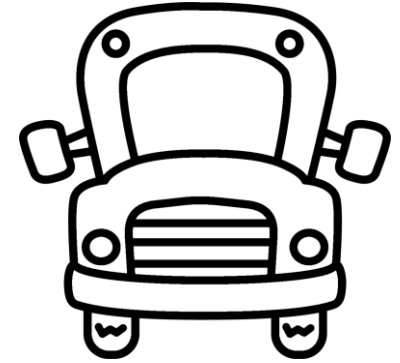

bus

Tara West - Little Minds at Work

CVC Encoding

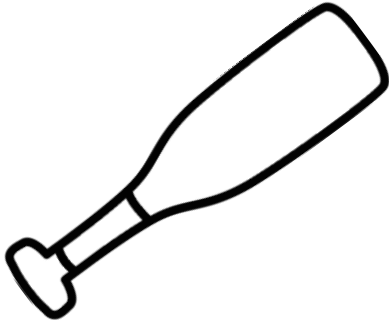

bat

Tara West - Little Minds at Work

CVC Encoding



bit

Tara West - Little Minds at Work

CVC Encoding



bad

Tara West - Little Minds at Work

CVC Encoding



gab

Tara West - Little Minds at Work

CVC Encoding

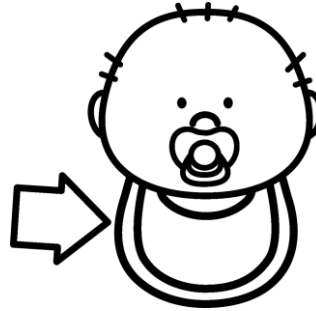

bib

Tara West - Little Minds at Work

CVC Encoding

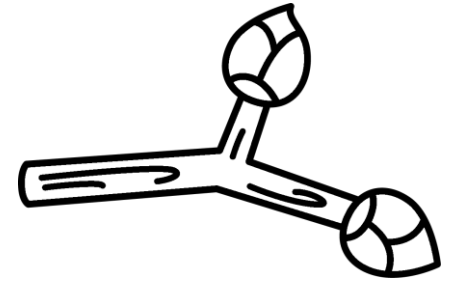

bud

Tara West - Little Minds at Work

CVC Encoding

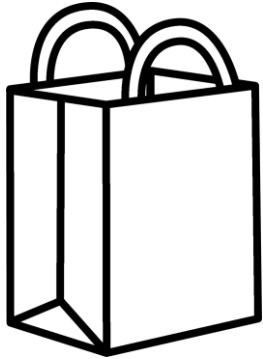

bag

Tara West - Little Minds at Work

CVC Encoding



cab

Tara West - Little Minds at Work

CVC Encoding

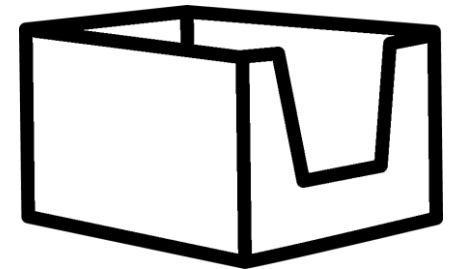

bin

Tara West - Little Minds at Work

CVC Encoding



dig

Tara West - Little Minds at Work

CVC Encoding

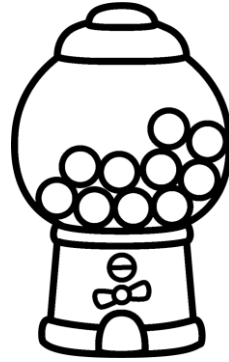

gum

Tara West - Little Minds at Work

CVC Encoding



big

Tara West - Little Minds at Work

CVC Encoding



dog

Tara West - Little Minds at Work

CVC Encoding



bug

Tara West - Little Minds at Work

CVC Encoding

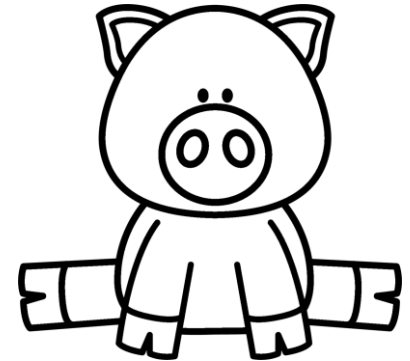

pig

Tara West - Little Minds at Work

CVC Encoding



den

Tara West - Little Minds at Work

CVC Encoding

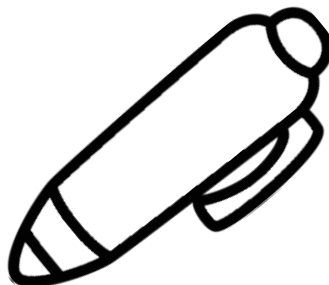

pen

Tara West - Little Minds at Work

CVC Encoding

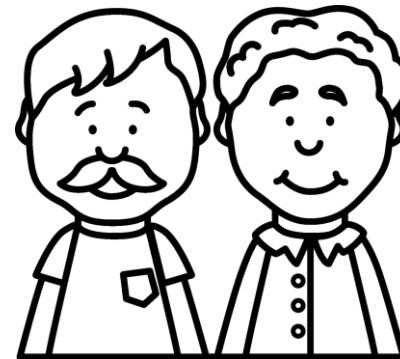

men

Tara West - Little Minds at Work

CVC Encoding

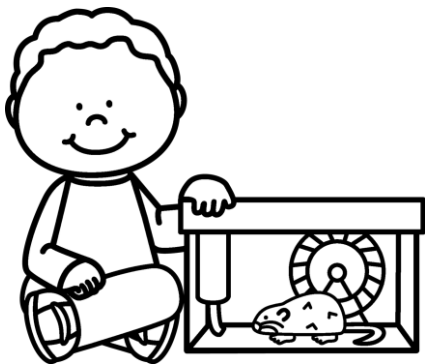

pet

Tara West - Little Minds at Work

CVC Encoding

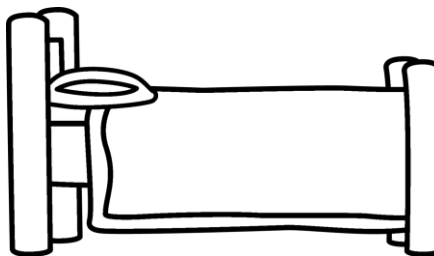

bed

Tara West - Little Minds at Work

CVC Encoding

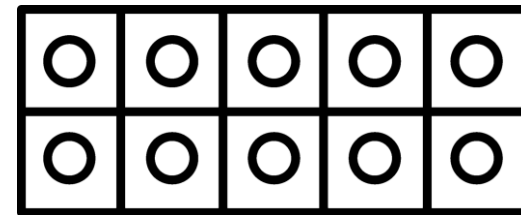

ten

Tara West - Little Minds at Work

CVC Encoding

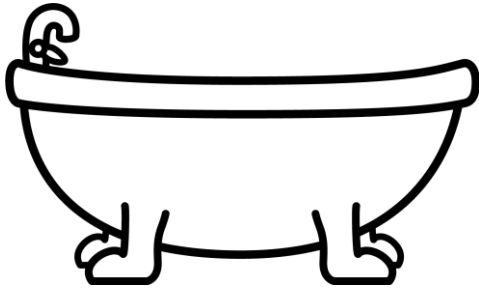

tub

Tara West - Little Minds at Work

CVC Encoding

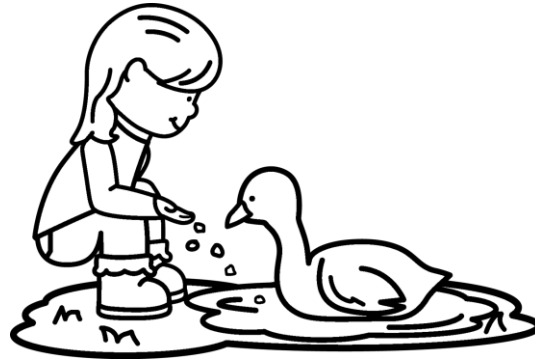

fed

Tara West - Little Minds at Work

CVC Encoding

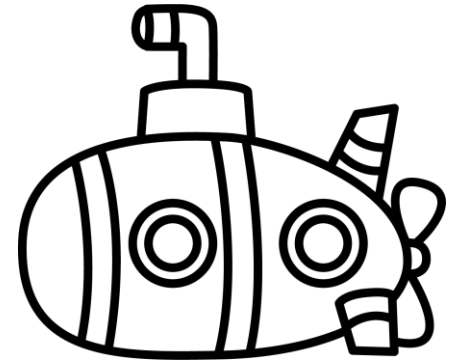

sub

Tara West - Little Minds at Work

CVC Encoding

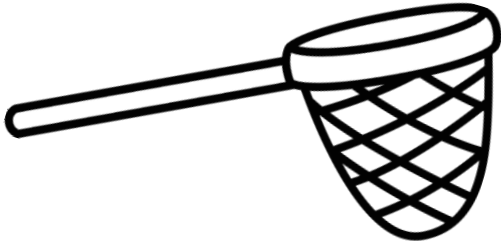

net

Tara West - Little Minds at Work

CVC Encoding



hum

Tara West - Little Minds at Work

CVC Encoding

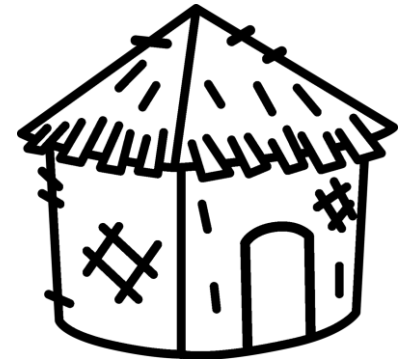

hut

Tara West - Little Minds at Work

CVC Encoding

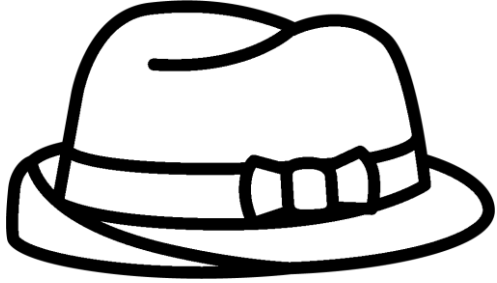

hat

Tara West - Little Minds at Work

CVC Encoding



hug

Tara West - Little Minds at Work

CVC Encoding

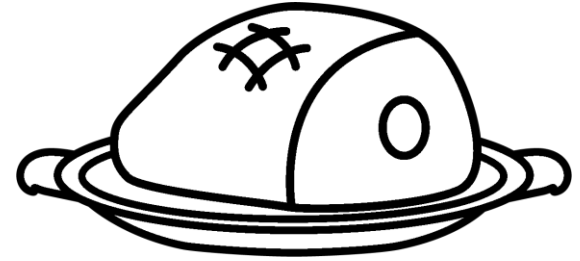

ham

Tara West - Little Minds at Work

CVC Encoding

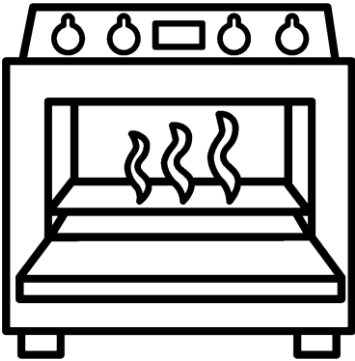

hot

Tara West - Little Minds at Work

CVC Encoding

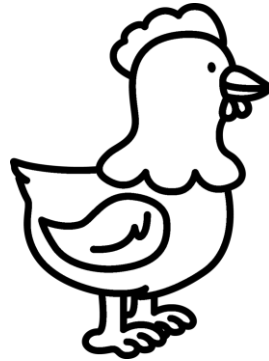

hen

Tara West - Little Minds at Work

CVC Encoding

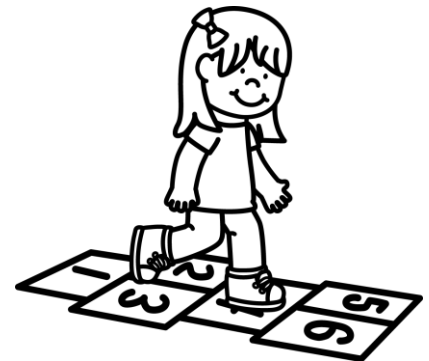

hop

Tara West - Little Minds at Work

CVC Encoding



rag

Tara West - Little Minds at Work

CVC Encoding

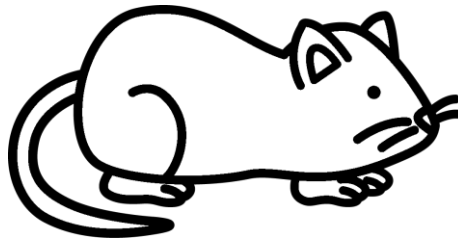

rat

Tara West - Little Minds at Work

CVC Encoding

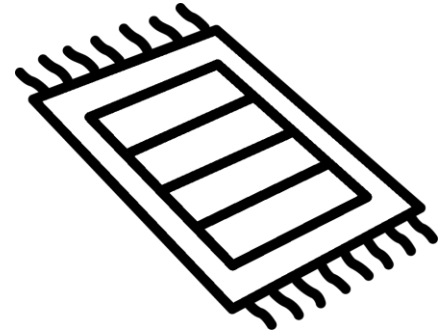

rug

Tara West - Little Minds at Work

CVC Encoding

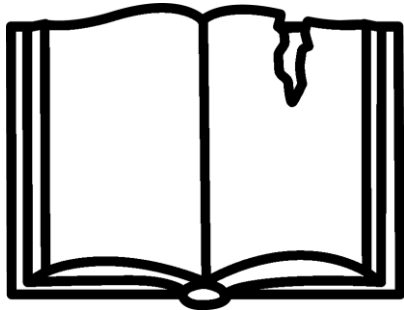

rip

Tara West - Little Minds at Work

CVC Encoding



rot

Tara West - Little Minds at Work

CVC Encoding

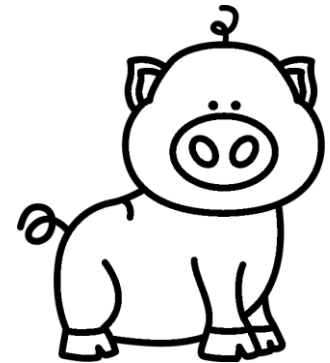

hog

Tara West - Little Minds at Work

CVC Encoding

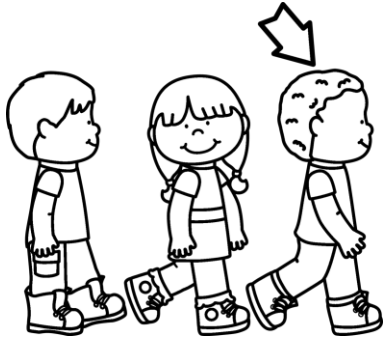

led

Tara West - Little Minds at Work

CVC Encoding

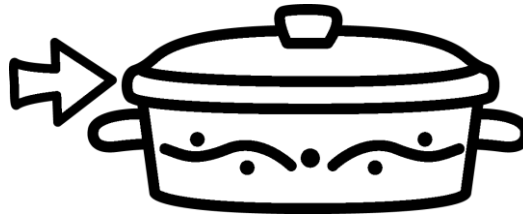

lid

Tara West - Little Minds at Work

CVC Encoding

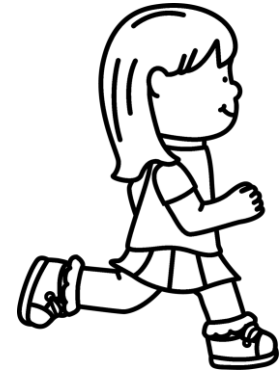

run

Tara West - Little Minds at Work

CVC Encoding

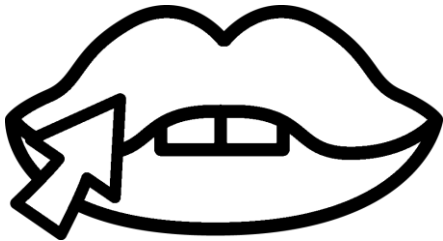

lip

Tara West - Little Minds at Work

CVC Encoding

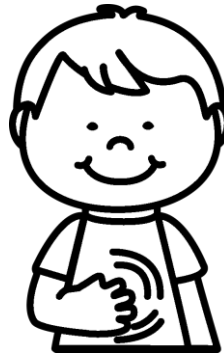

rub

Tara West - Little Minds at Work

CVC Encoding

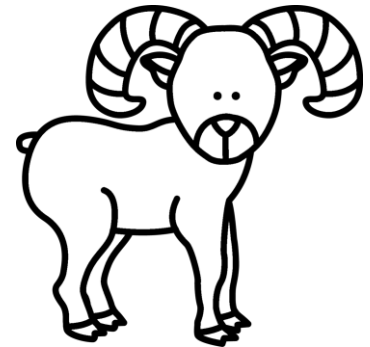

ram

Tara West - Little Minds at Work

CVC Encoding

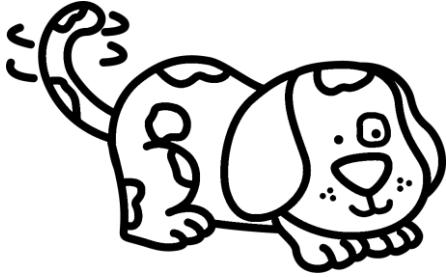

wag

Tara West - Little Minds at Work

CVC Encoding

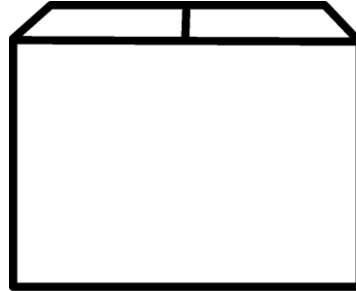

box

Tara West - Little Minds at Work

CVC Encoding



mix

Tara West - Little Minds at Work

CVC Encoding

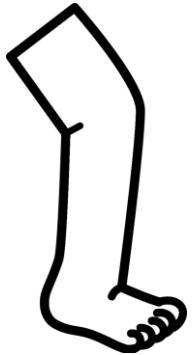

leg

Tara West - Little Minds at Work

CVC Encoding



lab

Tara West - Little Minds at Work

CVC Encoding

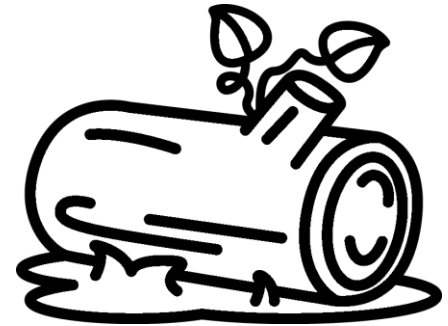

log

Tara West - Little Minds at Work

CVC Encoding



wed

Tara West - Little Minds at Work

CVC Encoding

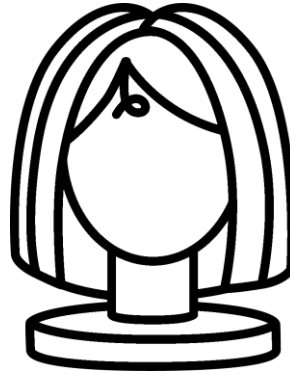

wig

Tara West - Little Minds at Work

CVC Encoding

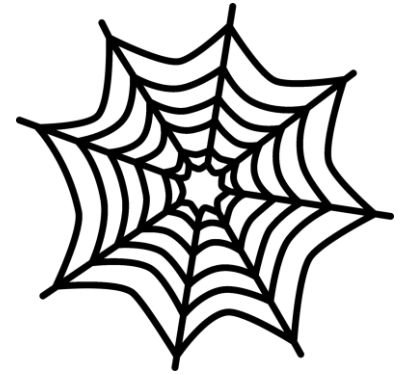

web

Tara West - Little Minds at Work

CVC Encoding

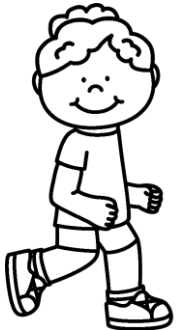

jog

Tara West - Little Minds at Work

CVC Encoding



win

Tara West - Little Minds at Work

CVC Encoding



wet

Tara West - Little Minds at Work

CVC Encoding

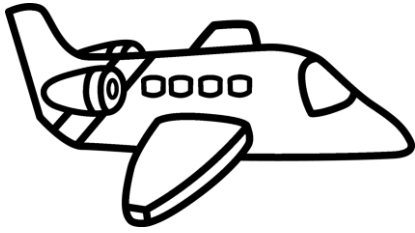

jet

Tara West - Little Minds at Work

CVC Encoding

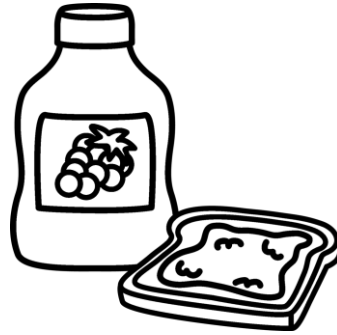

jam

Tara West - Little Minds at Work

CVC Encoding

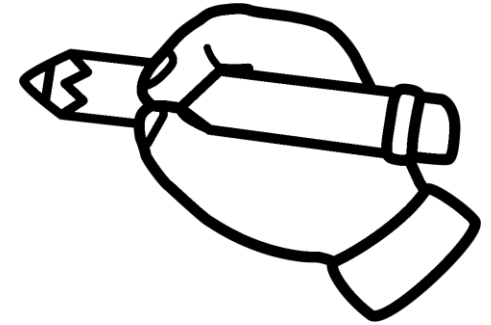

jot

Tara West - Little Minds at Work

CVC Encoding



job

Tara West - Little Minds at Work

CVC Encoding



jug

Tara West - Little Minds at Work

CVC Encoding



yum

Tara West - Little Minds at Work

CVC Encoding

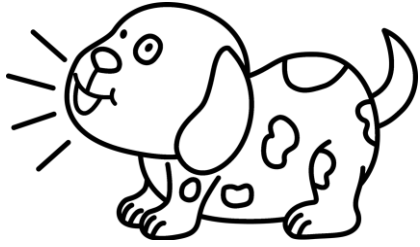

wag

Tara West - Little Minds at Work

CVC Encoding



yes

Tara West - Little Minds at Work

CVC Encoding



wax

Tara West - Little Minds at Work

CVC Encoding

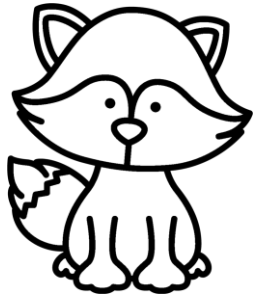

fox

Tara West - Little Minds at Work

CVC Encoding

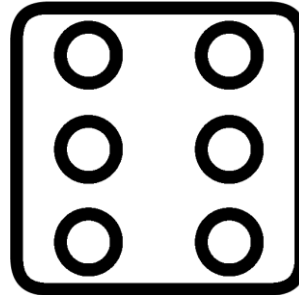

six

Tara West - Little Minds at Work

CVC Encoding



yam

Tara West - Little Minds at Work

CVC Encoding

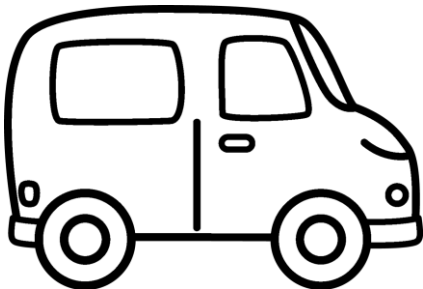

van

Tara West - Little Minds at Work

CVC Encoding

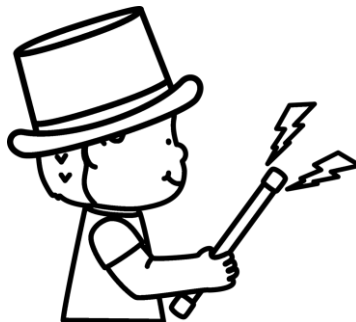

zap

Tara West - Little Minds at Work

CVC Encoding

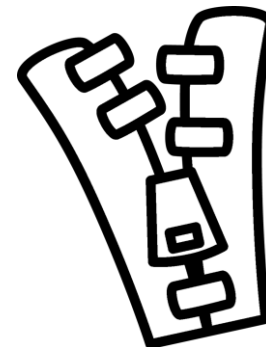

zip

Tara West - Little Minds at Work

CVC Encoding



zag

Tara West - Little Minds at Work

Digraphs Encoding

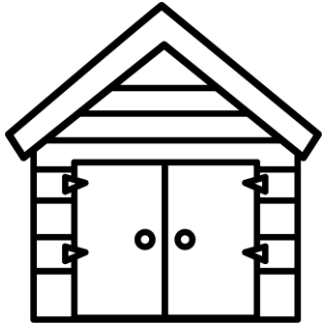

shed

Tara West - Little Minds at Work

Digraphs Encoding



cash

Tara West - Little Minds at Work

Digraphs Encoding



shut

Tara West - Little Minds at Work

Digraphs Encoding

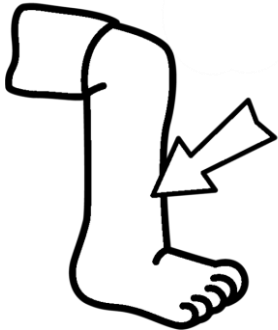

shin

Tara West - Little Minds at Work

Digraphs Encoding



rash

Tara West - Little Minds at Work

Digraphs Encoding



dish

Tara West - Little Minds at Work

Digraphs Encoding

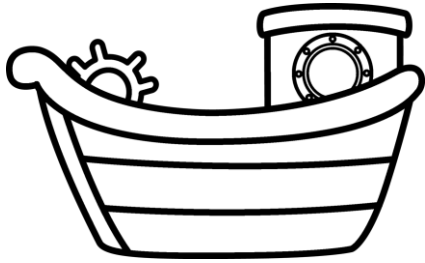

ship

Tara West - Little Minds at Work

Digraphs Encoding



shot

Tara West - Little Minds at Work

Digraphs Encoding

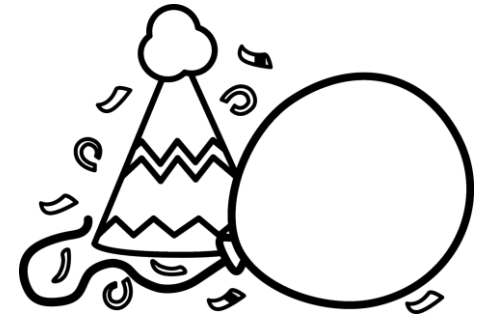

bash

Tara West - Little Minds at Work

Digraphs Encoding



shop

Tara West - Little Minds at Work

Digraphs Encoding

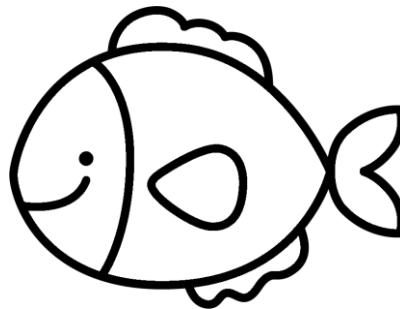

fish

Tara West - Little Minds at Work

Digraphs Encoding

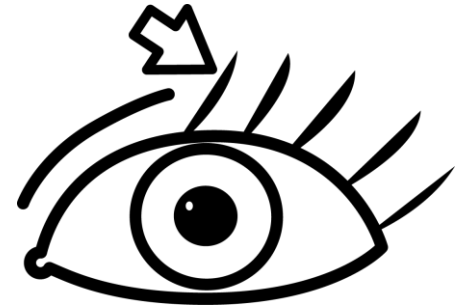

lash

Tara West - Little Minds at Work

Digraphs Encoding



thud

Tara West - Little Minds at Work

Digraphs Encoding

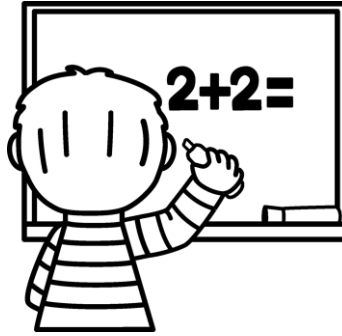

math

Tara West - Little Minds at Work

Digraphs Encoding



bath

Tara West - Little Minds at Work

Digraphs Encoding

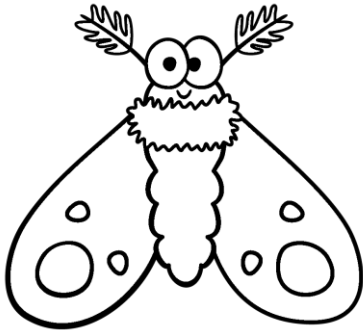

moth

Tara West - Little Minds at Work

Digraphs Encoding

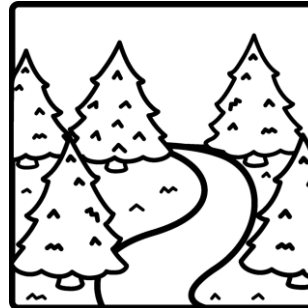

path

Tara West - Little Minds at Work

Digraphs Encoding

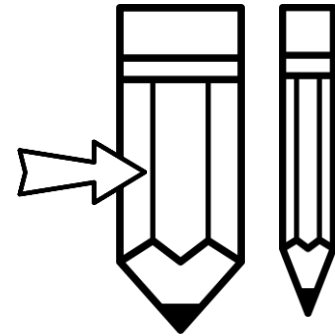

thick

Tara West - Little Minds at Work

Digraphs Encoding



chin

Tara West - Little Minds at Work

Digraphs Encoding



chat

Tara West - Little Minds at Work

Digraphs Encoding



check

Tara West - Little Minds at Work

Digraphs Encoding



chop

Tara West - Little Minds at Work

Digraphs Encoding

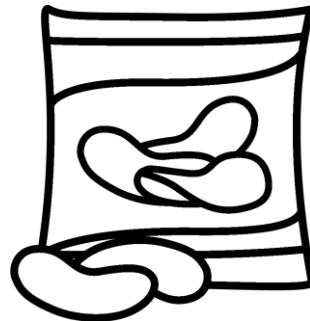

chip

Tara West - Little Minds at Work

Digraphs Encoding

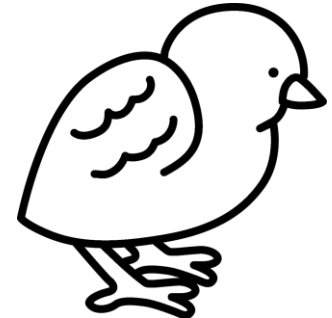

chick

Tara West - Little Minds at Work

Digraphs Encoding

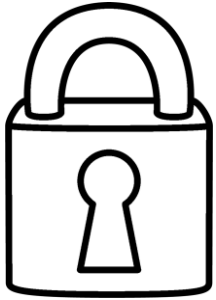

lock

Tara West - Little Minds at Work

Digraphs Encoding



pack

Tara West - Little Minds at Work

Digraphs Encoding



sack

Tara West - Little Minds at Work

Digraphs Encoding

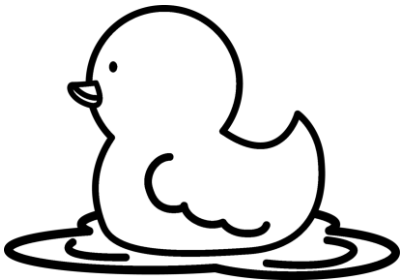

duck

Tara West - Little Minds at Work

Digraphs Encoding



sick

Tara West - Little Minds at Work

Digraphs Encoding

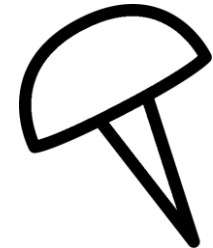

tack

Tara West - Little Minds at Work

Double Endings Encoding

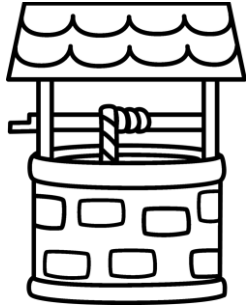

well

Tara West - Little Minds at Work

Double Endings Encoding



hill

Tara West - Little Minds at Work

Double Endings Encoding



yell

Tara West - Little Minds at Work

Double Endings Encoding



pill

Tara West - Little Minds at Work

Double Endings Encoding

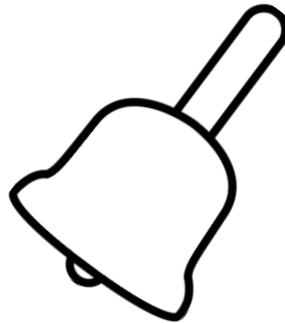

bell

Tara West - Little Minds at Work

Double Endings Encoding

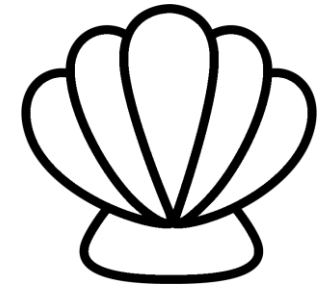

shell

Tara West - Little Minds at Work

Double Endings Encoding



whiff

Tara West - Little Minds at Work

Double Endings Encoding

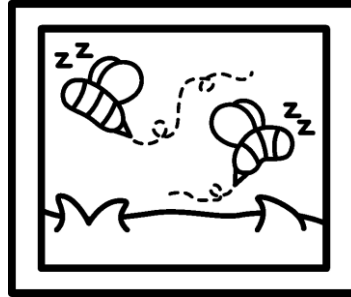

buzz

Tara West - Little Minds at Work

Double Endings Encoding

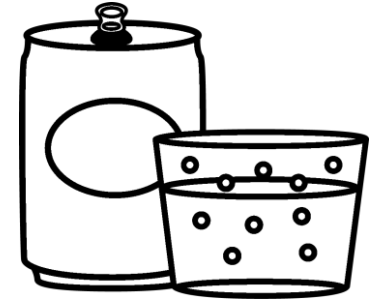

fizz

Tara West - Little Minds at Work

Double Endings Encoding

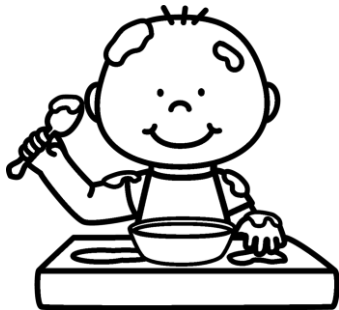

mess

Tara West - Little Minds at Work

Double Endings Encoding

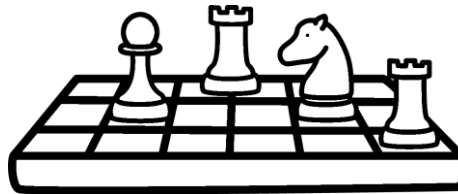

chess

Tara West - Little Minds at Work

Double Endings Encoding

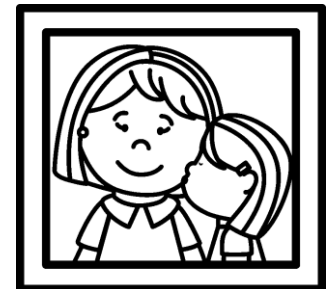

kiss

Tara West - Little Minds at Work

CCVC Encoding

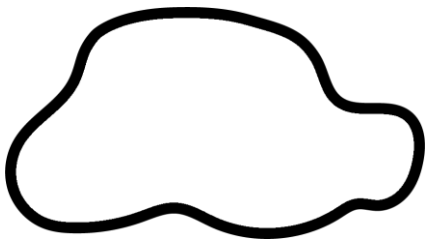

blob

Tara West - Little Minds at Work

CCVC Encoding



slip

Tara West - Little Minds at Work

CCVC Encoding

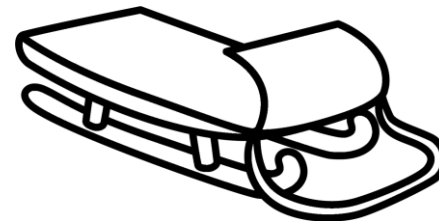

sled

Tara West - Little Minds at Work

CCVC Encoding



glad

Tara West - Little Minds at Work

CCVC Encoding

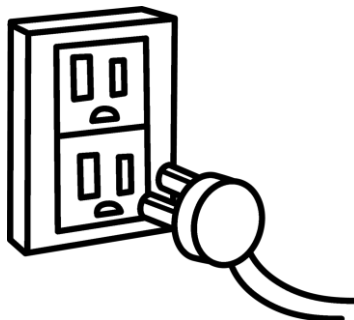

plug

Tara West - Little Minds at Work

CCVC Encoding

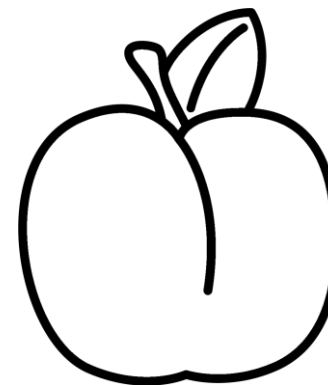

plum

Tara West - Little Minds at Work

CCVC Encoding

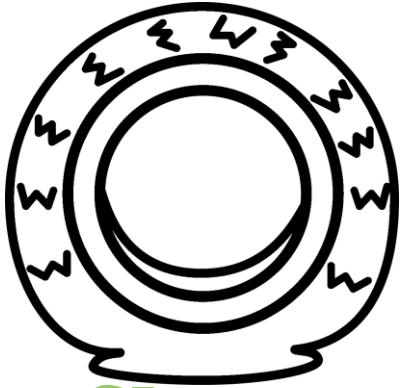

flat

Tara West - Little Minds at Work

CCVC Encoding

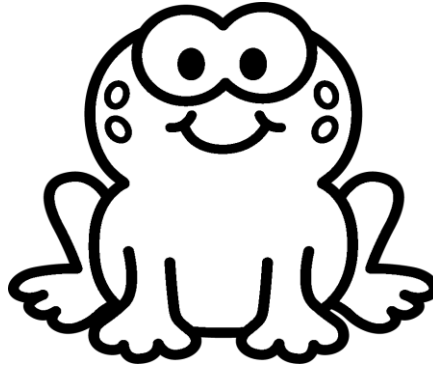

frog

Tara West - Little Minds at Work

CCVC Encoding

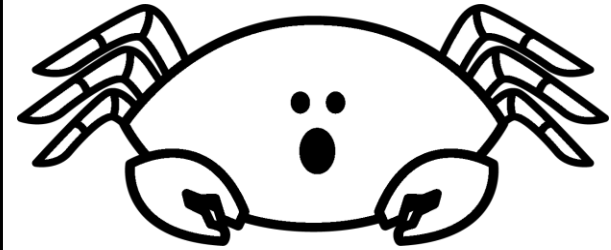

crab

Tara West - Little Minds at Work

CCVC Encoding

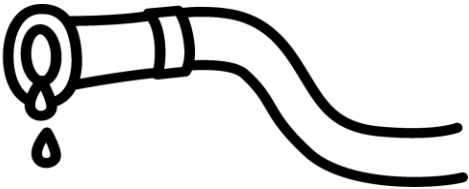

drip

Tara West - Little Minds at Work

CCVC Encoding

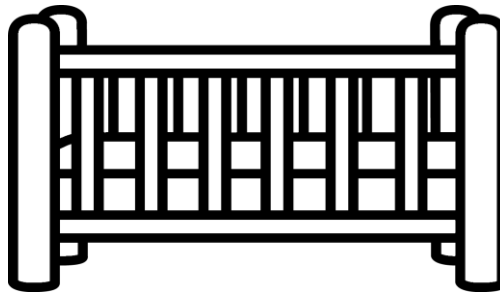

crib

Tara West - Little Minds at Work

CCVC Encoding



snap

Tara West - Little Minds at Work

CCVC Encoding

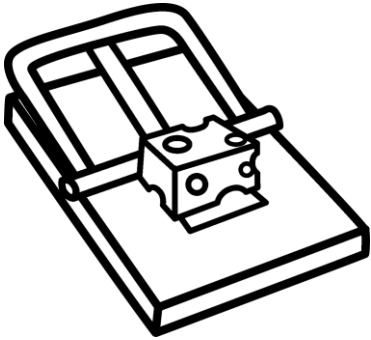

trap

Tara West - Little Minds at Work

CCVC Encoding

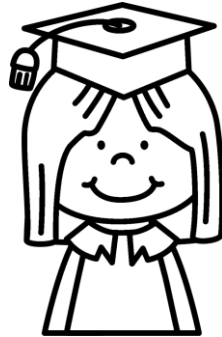

grad

Tara West - Little Minds at Work

CCVC Encoding



drag

Tara West - Little Minds at Work

CCVC Encoding

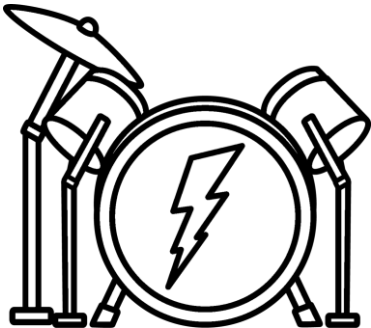

drum

Tara West - Little Minds at Work

CCVC Encoding



trip

Tara West - Little Minds at Work

CCVC Encoding

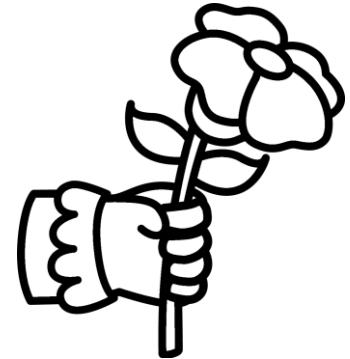

grab

Tara West - Little Minds at Work

CCVC Encoding

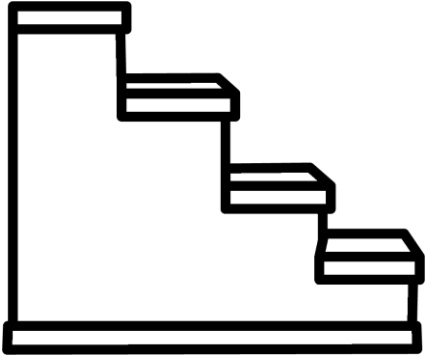

step

Tara West - Little Minds at Work

CCVC Encoding



spin

Tara West - Little Minds at Work

CCVC Encoding

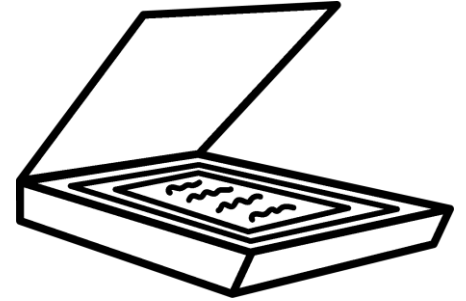

scan

Tara West - Little Minds at Work

CCVC Encoding

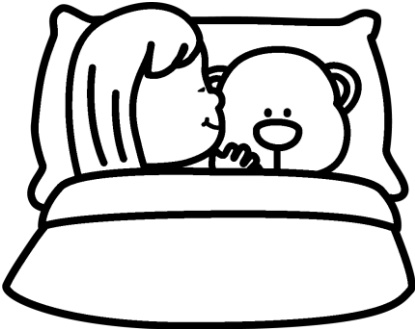

snug

Tara West - Little Minds at Work

CCVC Encoding



swim

Tara West - Little Minds at Work

CCVC Encoding



skip

Tara West - Little Minds at Work

CVCE Encoding

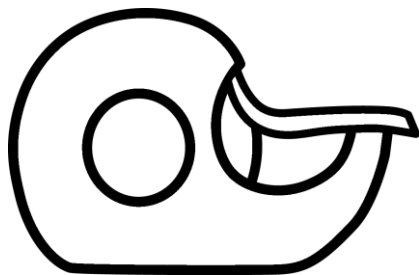

tape

Tara West - Little Minds at Work

CVCE Encoding

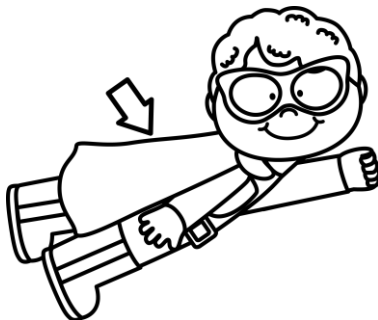

cape

Tara West - Little Minds at Work

CVCE Encoding



rake

Tara West - Little Minds at Work

CVCE Encoding

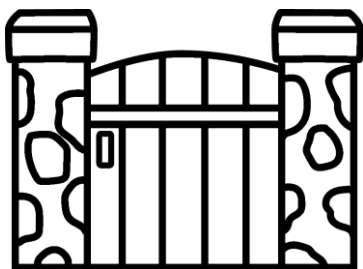

gate

Tara West - Little Minds at Work

CVCE Encoding



cake

Tara West - Little Minds at Work

CVCE Encoding

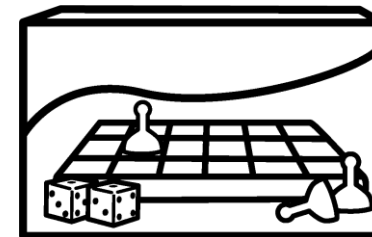

game

Tara West - Little Minds at Work

CVCE Encoding



cane

Tara West - Little Minds at Work

CVCE Encoding



wave

Tara West - Little Minds at Work

CVCE Encoding



mane

Tara West - Little Minds at Work

CVCE Encoding

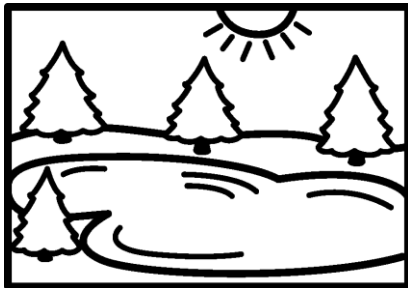

lake

Tara West - Little Minds at Work

CVCE Encoding



vase

Tara West - Little Minds at Work

CVCE Encoding



cave

Tara West - Little Minds at Work

CVCE Encoding



tame

Tara West - Little Minds at Work

CVCE Encoding

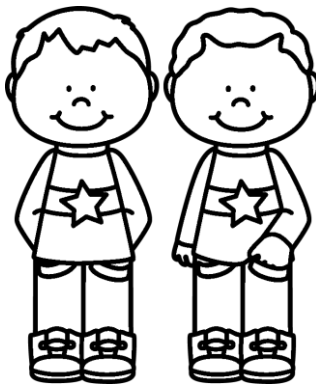

same

Tara West - Little Minds at Work

CVCE Encoding

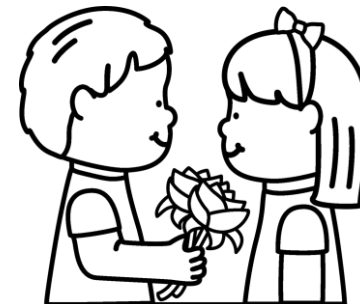

gave

Tara West - Little Minds at Work

CVCE Encoding



five

Tara West - Little Minds at Work

CVCE Encoding



name

Tara West - Little Minds at Work

CVCE Encoding

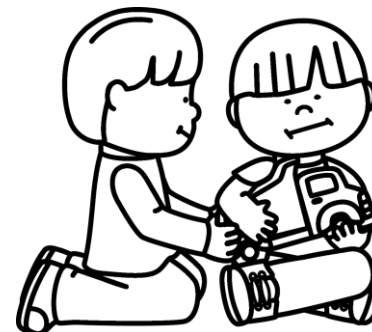

take

Tara West - Little Minds at Work

CVCE Encoding

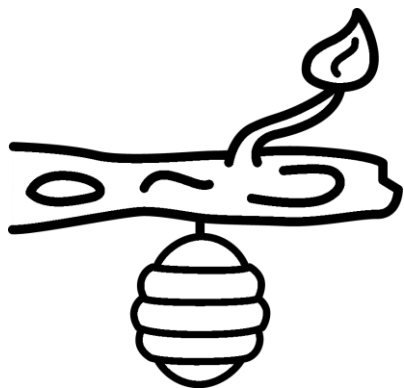

hive

Tara West - Little Minds at Work

CVCE Encoding

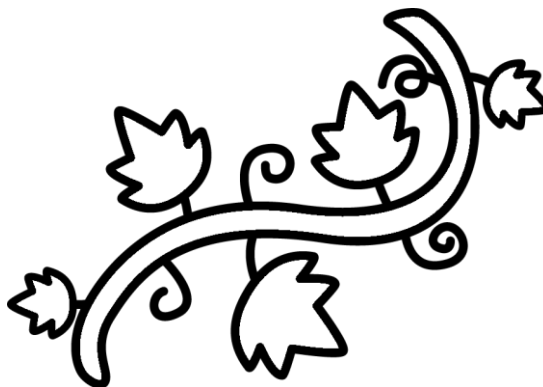

vine

Tara West - Little Minds at Work

CVCE Encoding

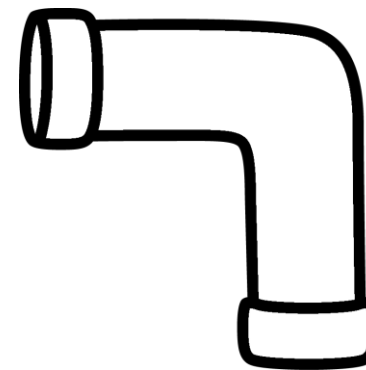

pipe

Tara West - Little Minds at Work

CVCE Encoding



bite

Tara West - Little Minds at Work

CVCE Encoding

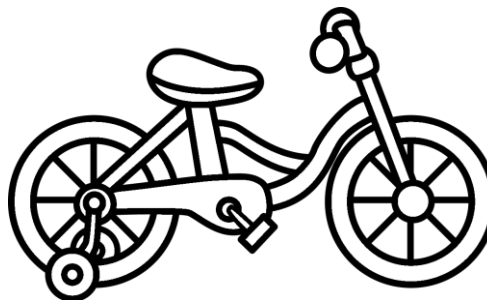

bike

Tara West - Little Minds at Work

CVCE Encoding



hike

Tara West - Little Minds at Work

CVCE Encoding

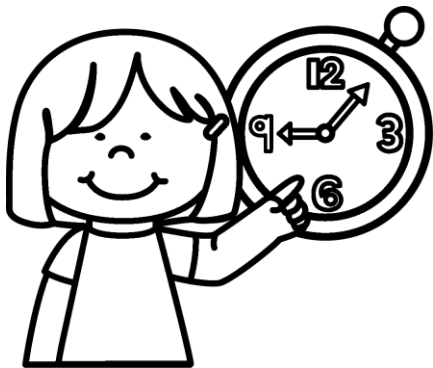

time

Tara West - Little Minds at Work

CVCE Encoding



nine

Tara West - Little Minds at Work

CVCE Encoding



dime

Tara West - Little Minds at Work

CVCE Encoding



hide

Tara West - Little Minds at Work

CVCE Encoding

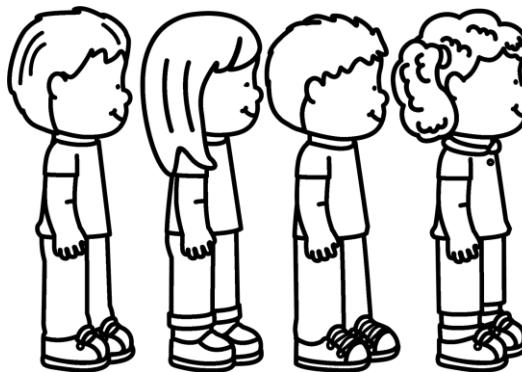

line

Tara West - Little Minds at Work

CVCE Encoding

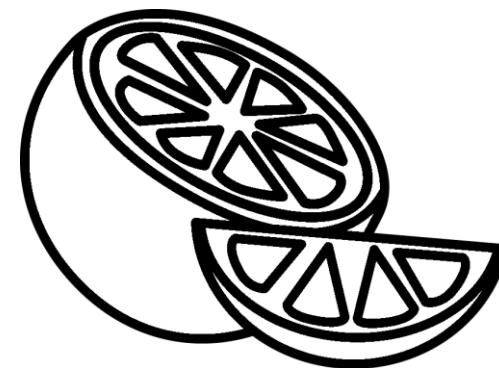

lime

Tara West - Little Minds at Work

CVCE Encoding



wipe

Tara West - Little Minds at Work

CVCE Encoding



like

Tara West - Little Minds at Work

CVCE Encoding

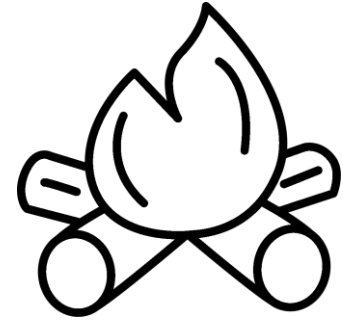

fire

Tara West - Little Minds at Work

CVCE Encoding

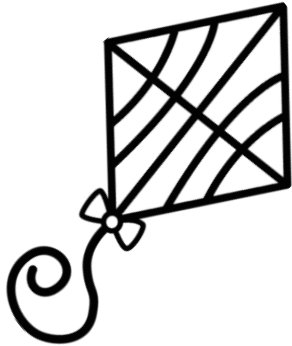

kite

Tara West - Little Minds at Work

CVCE Encoding



pine

Tara West - Little Minds at Work

CVCE Encoding

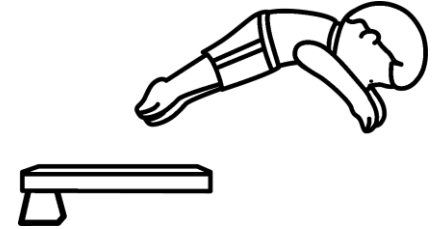

dive

Tara West - Little Minds at Work

CVCE Encoding

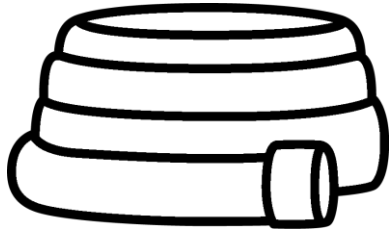

hose

Tara West - Little Minds at Work

CVCE Encoding

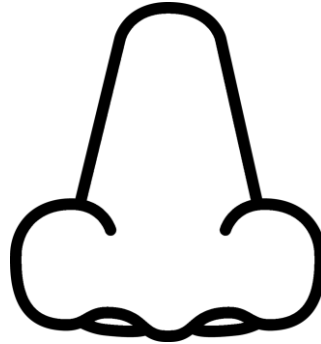

nose

Tara West - Little Minds at Work

CVCE Encoding

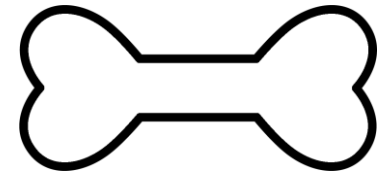

bone

Tara West - Little Minds at Work

CVCE Encoding



rose

Tara West - Little Minds at Work

CVCE Encoding

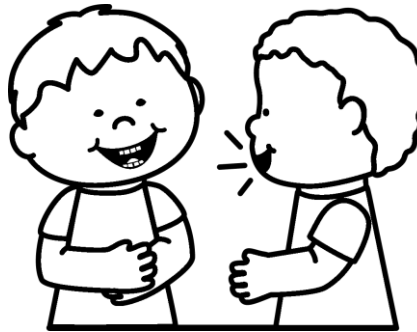

joke

Tara West - Little Minds at Work

CVCE Encoding



home

Tara West - Little Minds at Work

CVCE Encoding

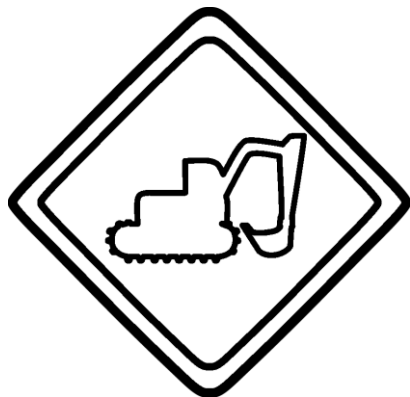

zone

Tara West - Little Minds at Work

CVCE Encoding



lobe

Tara West - Little Minds at Work

CVCE Encoding

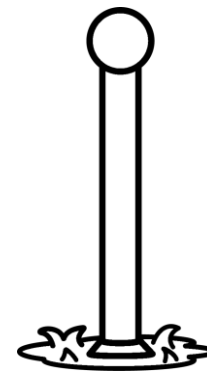

pole

Tara West - Little Minds at Work

CVCE Encoding

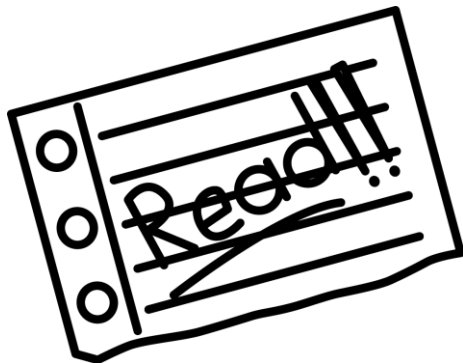

note

Tara West - Little Minds at Work

CVCE Encoding

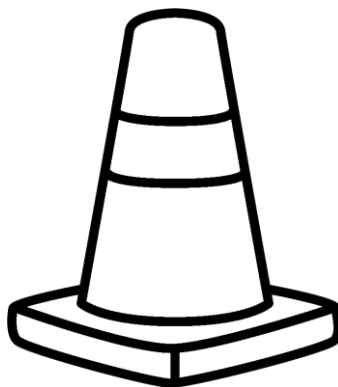

cone

Tara West - Little Minds at Work

CVCE Encoding



mole

Tara West - Little Minds at Work

CVCE Encoding

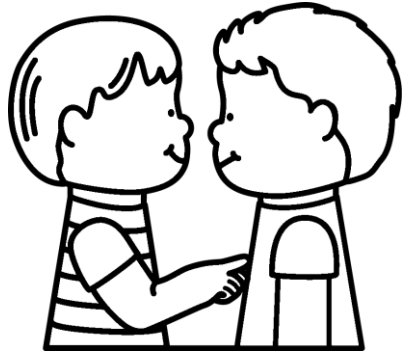

poke

Tara West - Little Minds at Work

CVCE Encoding



woke

Tara West - Little Minds at Work

CVCE Encoding

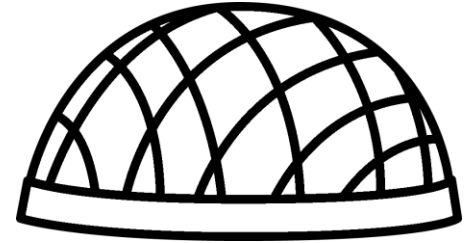

dome

Tara West - Little Minds at Work

CVCE Encoding

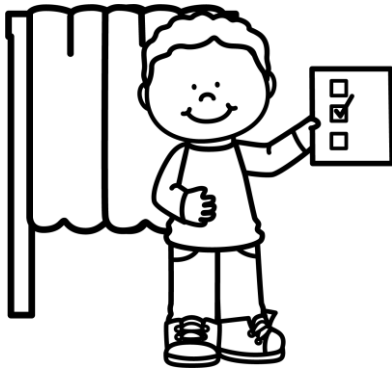

vote

Tara West - Little Minds at Work

CVCE Encoding



tote

Tara West - Little Minds at Work

CVCE Encoding

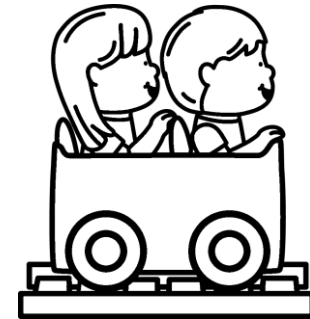

rode

Tara West - Little Minds at Work

CVCE Encoding

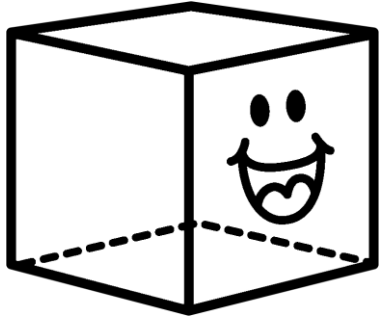

cube

Tara West - Little Minds at Work

CVCE Encoding

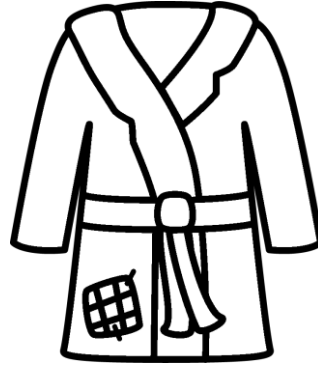

robe

Tara West - Little Minds at Work

CVCE Encoding



code

Tara West - Little Minds at Work

CVCE Encoding



dune

Tara West - Little Minds at Work

CVCE Encoding

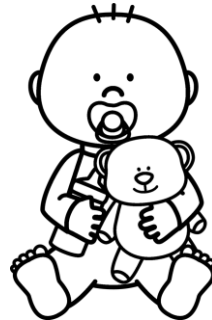

cute

Tara West - Little Minds at Work

CVCE Encoding



tube

Tara West - Little Minds at Work

CVCE Encoding



mute

Tara West - Little Minds at Work

CVCE Encoding

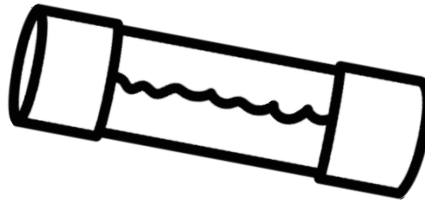

fuse

Tara West - Little Minds at Work

CVCE Encoding



tune

Tara West - Little Minds at Work

CVCE Encoding



fume

Tara West - Little Minds at Work

CVCE Encoding

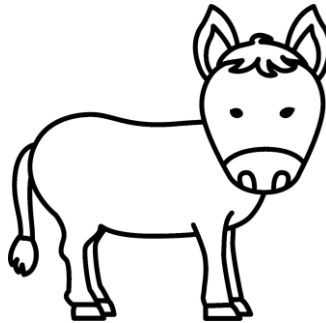

mule

Tara West - Little Minds at Work

CVCE Encoding



dude

Tara West - Little Minds at Work

CVCE Encoding

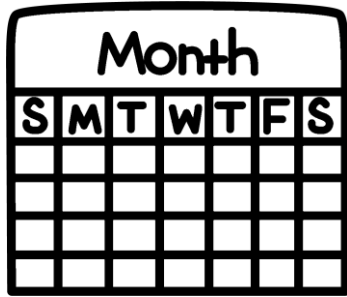

June

Tara West - Little Minds at Work

CVCE Encoding



rule

Tara West - Little Minds at Work

CVCE Encoding

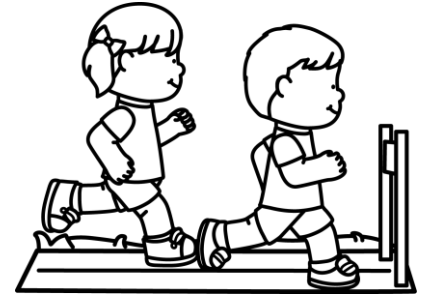

race

Tara West - Little Minds at Work

CVCE Encoding

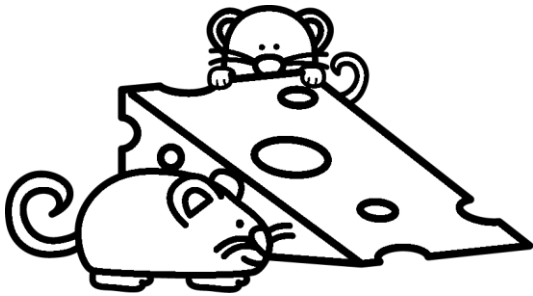

mice

Tara West - Little Minds at Work

CVCE Encoding



nice

Tara West - Little Minds at Work

CVCE Encoding



lace

Tara West - Little Minds at Work

CVCE Encoding



rage

Tara West - Little Minds at Work

CVCE Encoding

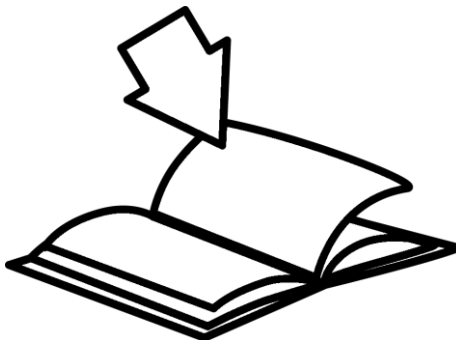

page

Tara West - Little Minds at Work

CVCE Encoding

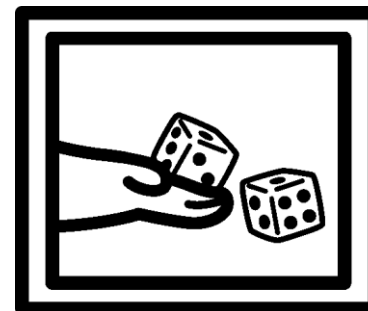

dice

Tara West - Little Minds at Work

CVCE Encoding

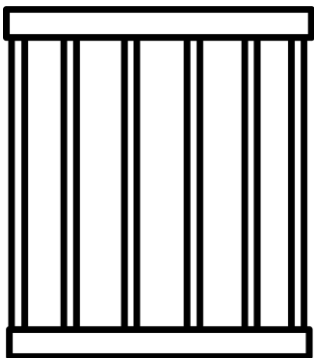

cage

Tara West - Little Minds at Work

CVCE Encoding

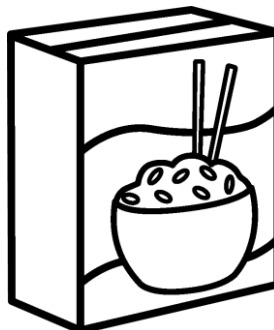

rice

Tara West - Little Minds at Work

CVCE Encoding



huge

Tara West - Little Minds at Work

CVCC Encoding

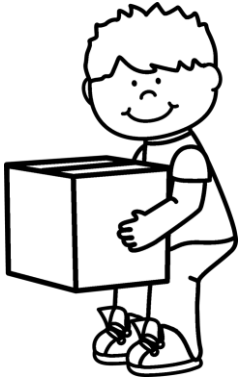

lift

Tara West - Little Minds at Work

CVCC Encoding

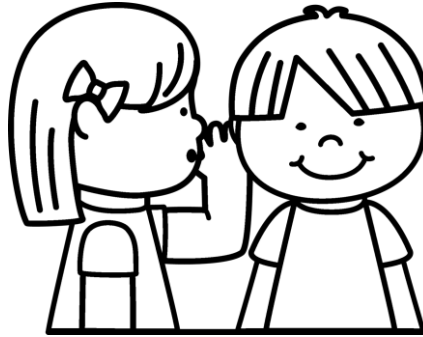

told

Tara West - Little Minds at Work

CVCC Encoding

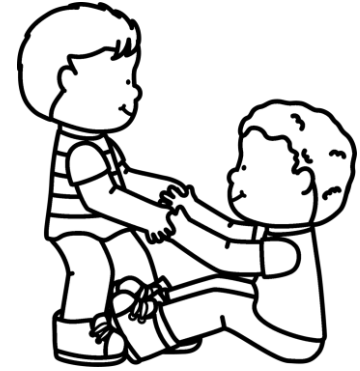

help

Tara West - Little Minds at Work

CVCC Encoding

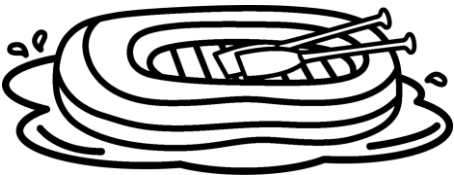

raft

Tara West - Little Minds at Work

CVCC Encoding



gulp

Tara West - Little Minds at Work

CVCC Encoding



fold

Tara West - Little Minds at Work

CVCC Encoding



golf

Tara West - Little Minds at Work

CVCC Encoding

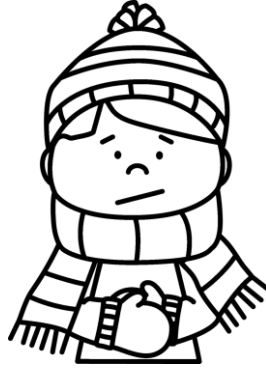

cold

Tara West - Little Minds at Work

CVCC Encoding



gift

Tara West - Little Minds at Work

CVCC Encoding

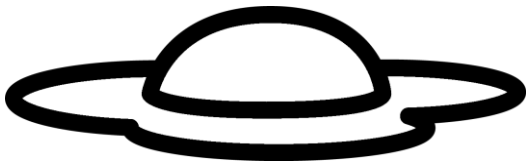

yolk

Tara West - Little Minds at Work

CVCC Encoding



melt

Tara West - Little Minds at Work

CVCC Encoding

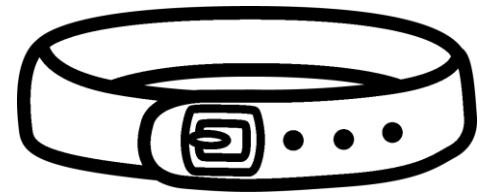

belt

Tara West - Little Minds at Work

CVCC Encoding



sand

Tara West - Little Minds at Work

CVCC Encoding

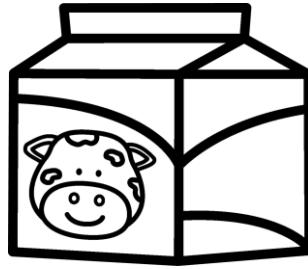

milk

Tara West - Little Minds at Work

CVCC Encoding



self

Tara West - Little Minds at Work

CVCC Encoding

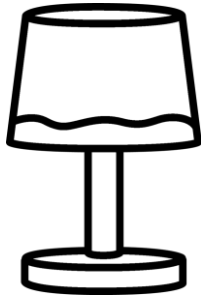

lamp

Tara West - Little Minds at Work

CVCC Encoding



dump

Tara West - Little Minds at Work

CVCC Encoding

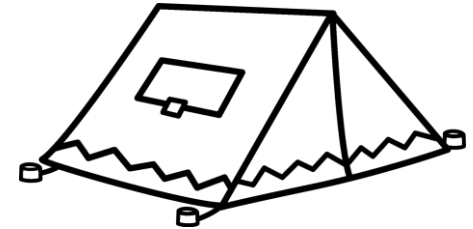

tent

Tara West - Little Minds at Work

CVCC Encoding

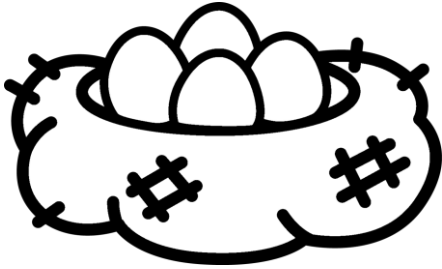

nest

Tara West - Little Minds at Work

CVCC Encoding



mask

Tara West - Little Minds at Work

CVCC Encoding

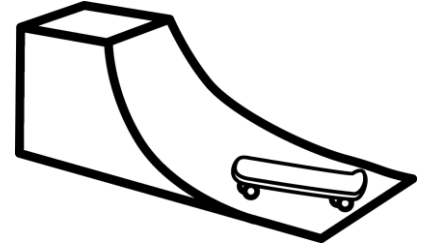

ramp

Tara West - Little Minds at Work

CVCC Encoding

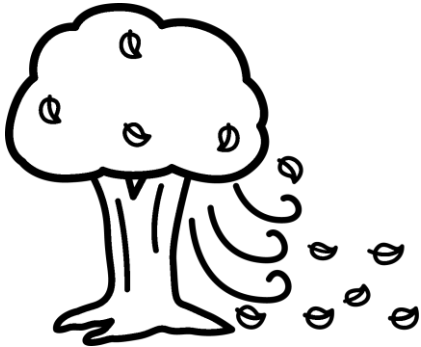

wind

Tara West - Little Minds at Work

CVCC Encoding

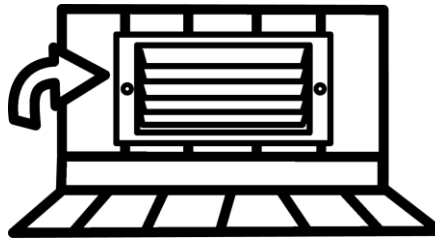

vent

Tara West - Little Minds at Work

CVCC Encoding



hand

Tara West - Little Minds at Work

CVCC Encoding

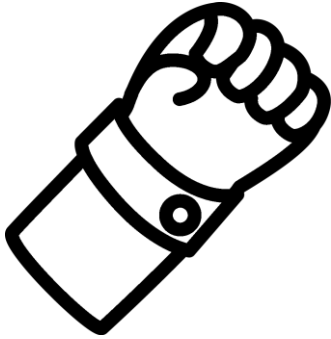

fist

Tara West - Little Minds at Work

CVCC Encoding



gasp

Tara West - Little Minds at Work

CVCC Encoding



vest

Tara West - Little Minds at Work

CVCC Encoding



cast

Tara West - Little Minds at Work

CVCC Encoding

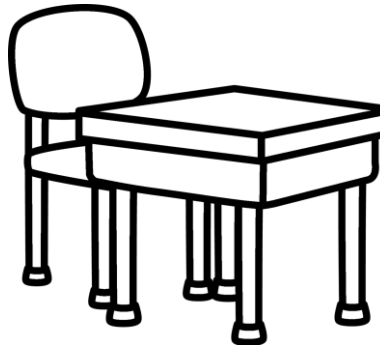

desk

Tara West - Little Minds at Work

CVCC Encoding



wept

Tara West - Little Minds at Work

CVCC Encoding

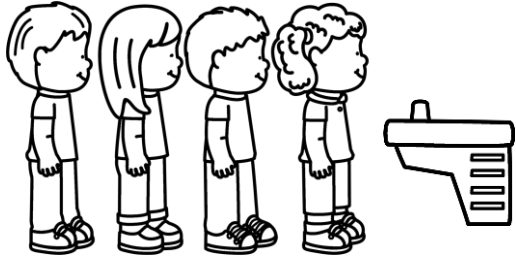

next

Tara West - Little Minds at Work

CVCC Encoding

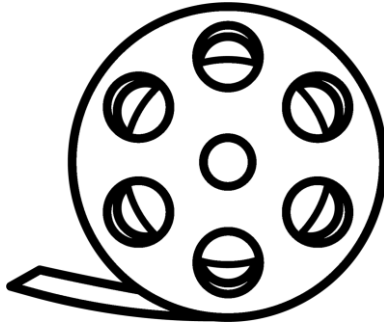

film

Tara West - Little Minds at Work

CVCC Encoding

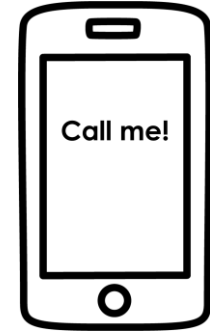

test

Tara West - Little Minds at Work

CVCC Encoding

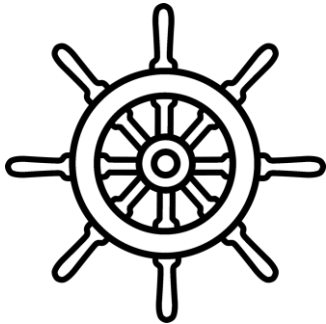

helm

Tara West - Little Minds at Work

R-Controlled Encoding



harp

Tara West - Little Minds at Work

R-Controlled Encoding

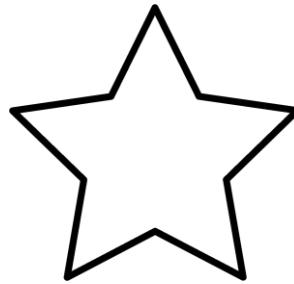

star

Tara West - Little Minds at Work

R-Controlled Encoding



barn

Tara West - Little Minds at Work

R-Controlled Encoding

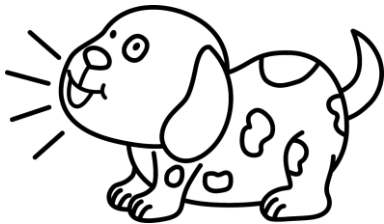

bark

Tara West - Little Minds at Work

R-Controlled Encoding

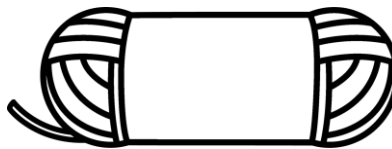

yarn

Tara West - Little Minds at Work

R-Controlled Encoding

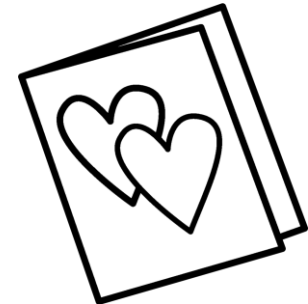

card

Tara West - Little Minds at Work

R-Controlled Encoding



fork

Tara West - Little Minds at Work

R-Controlled Encoding

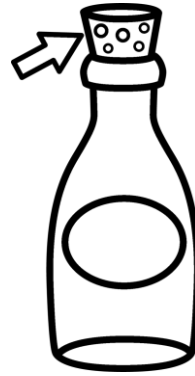

cork

Tara West - Little Minds at Work

R-Controlled Encoding



park

Tara West - Little Minds at Work

R-Controlled Encoding

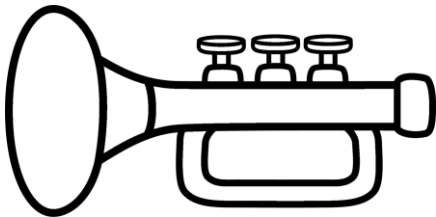

horn

Tara West - Little Minds at Work

R-Controlled Encoding

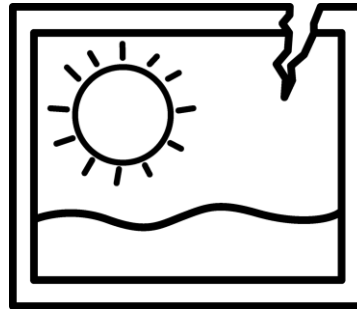

torn

Tara West - Little Minds at Work

R-Controlled Encoding

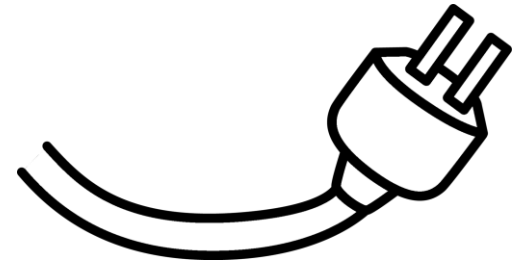

cord

Tara West - Little Minds at Work

R-Controlled Encoding

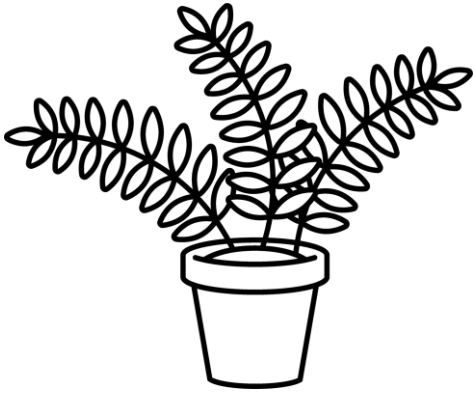

fern

Tara West - Little Minds at Work

R-Controlled Encoding



perm

Tara West - Little Minds at Work

R-Controlled Encoding

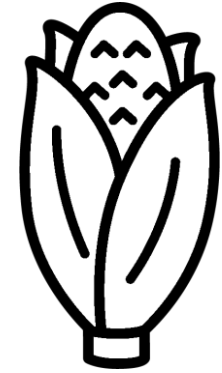

corn

Tara West - Little Minds at Work

R-Controlled Encoding

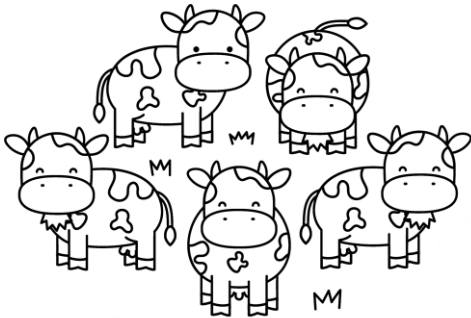

herd

Tara West - Little Minds at Work

R-Controlled Encoding

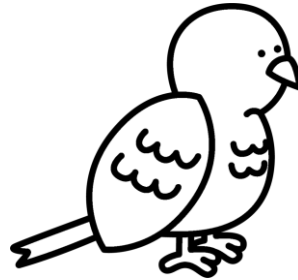

bird

Tara West - Little Minds at Work

R-Controlled Encoding



dirt

Tara West - Little Minds at Work

R-Controlled Encoding

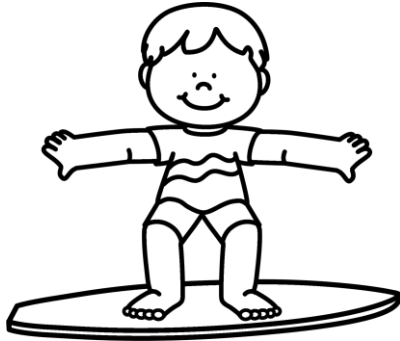

surf

Tara West - Little Minds at Work

R-Controlled Encoding

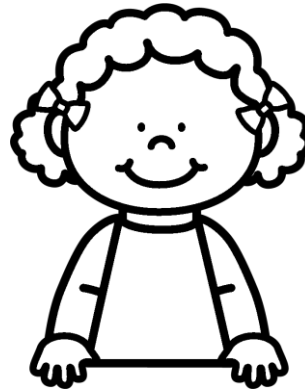

girl

Tara West - Little Minds at Work

R-Controlled Encoding



stir

Tara West - Little Minds at Work

R-Controlled Encoding

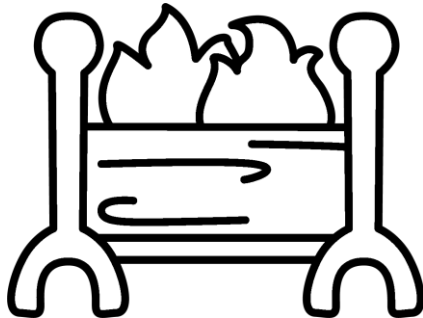

burn

Tara West - Little Minds at Work

R-Controlled Encoding

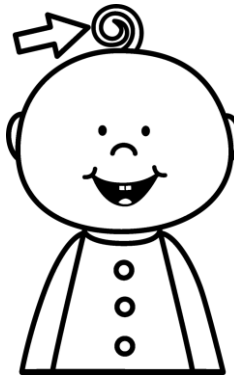

curl

Tara West - Little Minds at Work

R-Controlled Encoding



hurl

Tara West - Little Minds at Work

R-Controlled Encoding

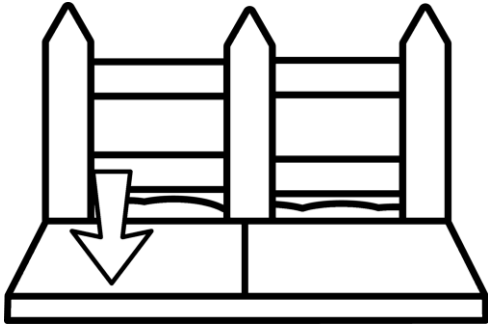

curb

Tara West - Little Minds at Work

R-Controlled Encoding

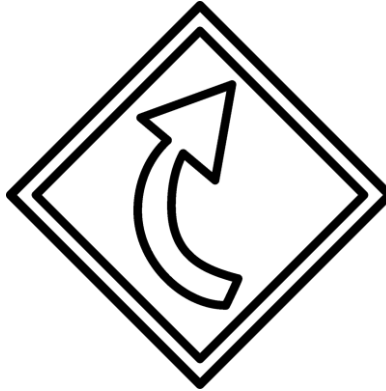

turn

Tara West - Little Minds at Work

R-Controlled Encoding

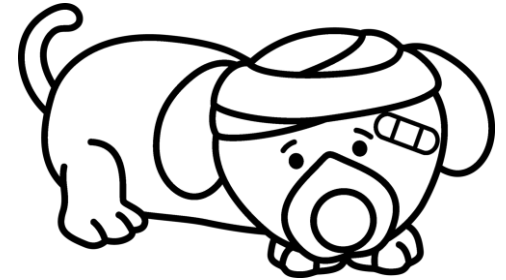

hurt

Tara West - Little Minds at Work

R-Controlled Encoding



burn

Tara West - Little Minds at Work

Vowel Variants Encoding



rain

Tara West - Little Minds at Work

Vowel Variants Encoding

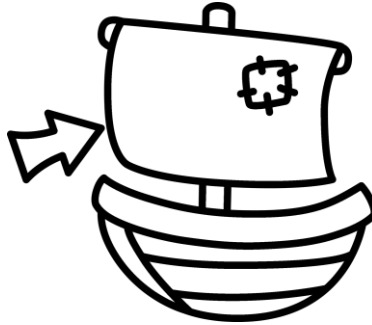

sail

Tara West - Little Minds at Work

Vowel Variants Encoding



tray

Tara West - Little Minds at Work

Vowel Variants Encoding

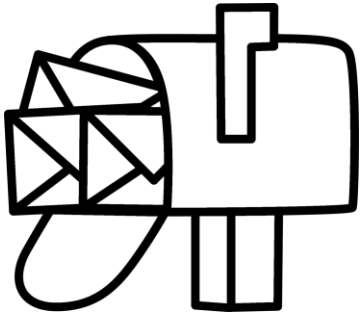

mail

Tara West - Little Minds at Work

Vowel Variants Encoding

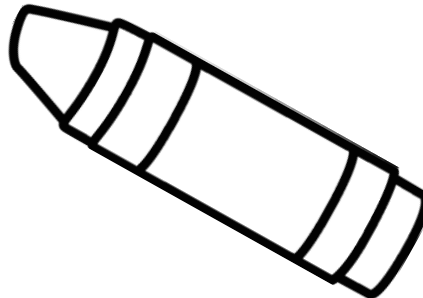

gray

Tara West - Little Minds at Work

Vowel Variants Encoding



play

Tara West - Little Minds at Work

Vowel Variants Encoding

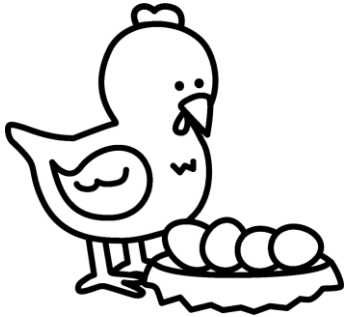

laid

Tara West - Little Minds at Work

Vowel Variants Encoding



paid

Tara West - Little Minds at Work

Vowel Variants Encoding

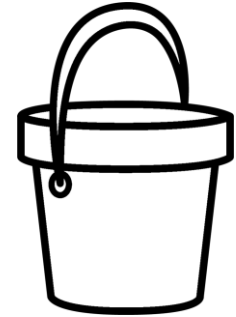

pail

Tara West - Little Minds at Work

Vowel Variants Encoding



pain

Tara West - Little Minds at Work

Vowel Variants Encoding

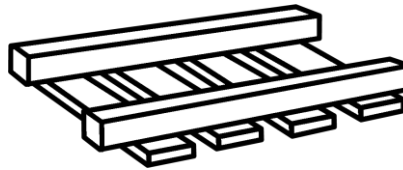

rail

Tara West - Little Minds at Work

Vowel Variants Encoding

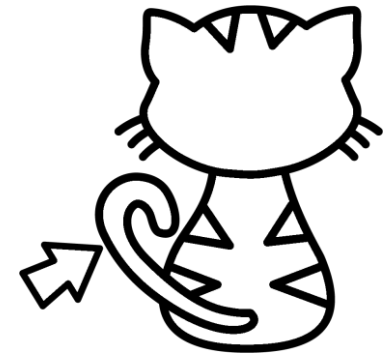

tail

Tara West - Little Minds at Work

Vowel Variants Encoding

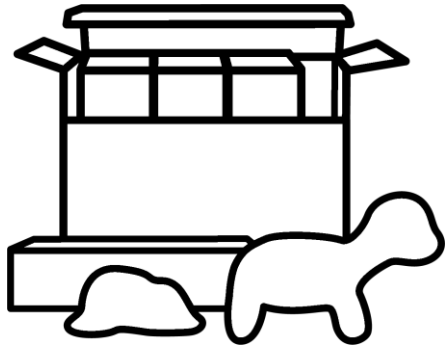

clay

Tara West - Little Minds at Work

Vowel Variants Encoding



weed

Tara West - Little Minds at Work

Vowel Variants Encoding

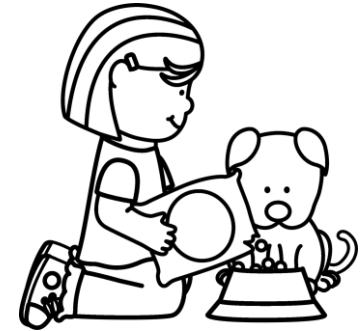

feed

Tara West - Little Minds at Work

Vowel Variants Encoding



heel

Tara West - Little Minds at Work

Vowel Variants Encoding



peek

Tara West - Little Minds at Work

Vowel Variants Encoding

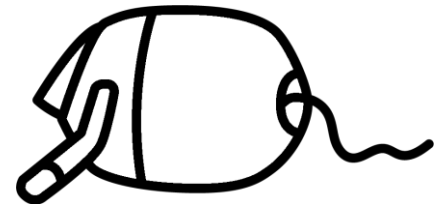

reel

Tara West - Little Minds at Work

Vowel Variants Encoding



leak

Tara West - Little Minds at Work

Vowel Variants Encoding



read

Tara West - Little Minds at Work

Vowel Variants Encoding

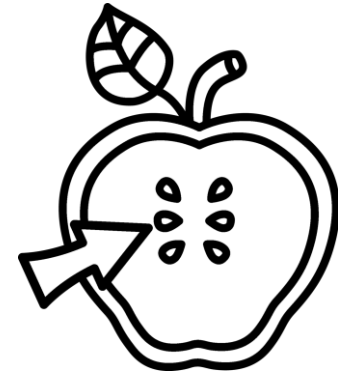

seed

Tara West - Little Minds at Work

Vowel Variants Encoding

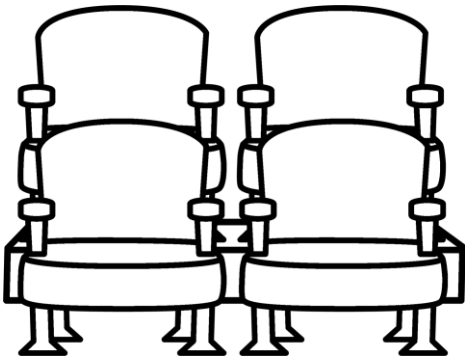

seat

Tara West - Little Minds at Work

Vowel Variants Encoding

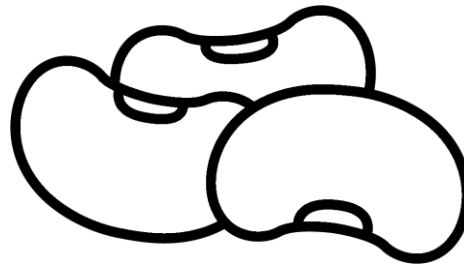

bean

Tara West - Little Minds at Work

Vowel Variants Encoding

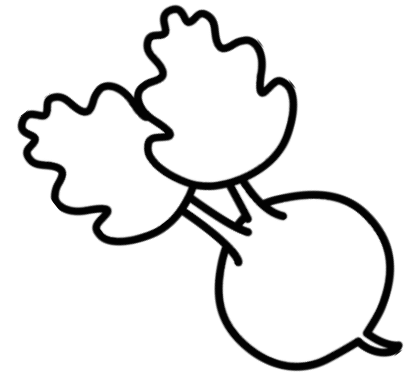

beet

Tara West - Little Minds at Work

Vowel Variants Encoding

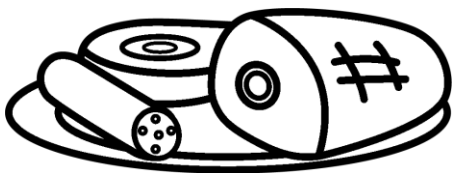

meat

Tara West - Little Minds at Work

Vowel Variants Encoding



bead

Tara West - Little Minds at Work

Vowel Variants Encoding

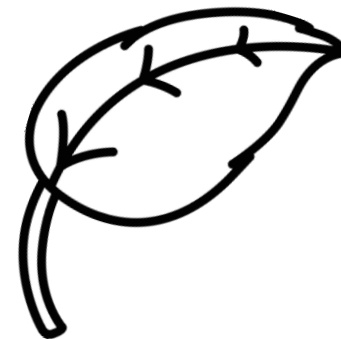

leaf

Tara West - Little Minds at Work

Vowel Variants Encoding

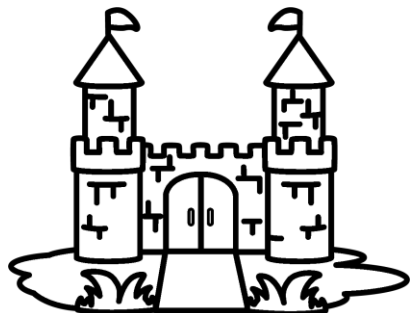

moat

Tara West - Little Minds at Work

Vowel Variants Encoding

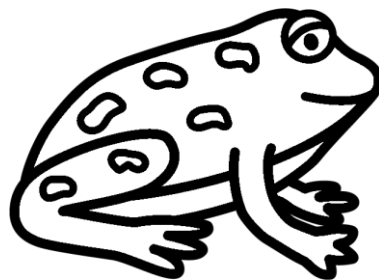

toad

Tara West - Little Minds at Work

Vowel Variants Encoding



load

Tara West - Little Minds at Work

Vowel Variants Encoding



road

Tara West - Little Minds at Work

Vowel Variants Encoding

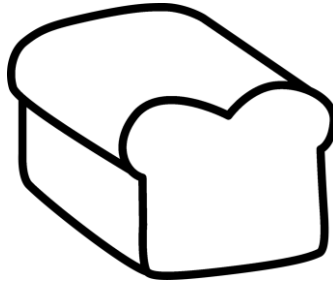

loaf

Tara West - Little Minds at Work

Vowel Variants Encoding

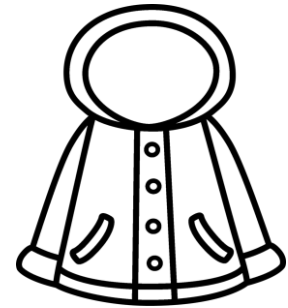

coat

Tara West - Little Minds at Work

Vowel Variants Encoding



soap

Tara West - Little Minds at Work

Vowel Variants Encoding

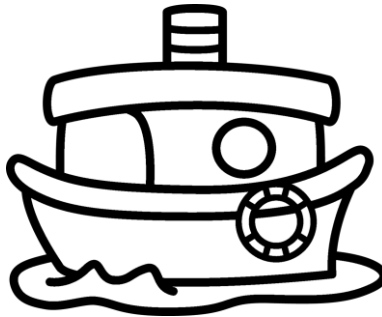

boat

Tara West - Little Minds at Work

Vowel Variants Encoding

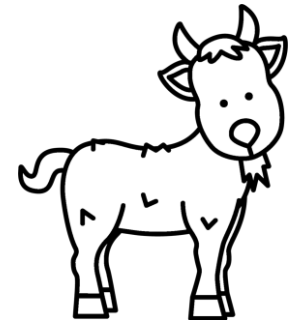

goat

Tara West - Little Minds at Work

Vowel Variants Encoding



haul

Tara West - Little Minds at Work

Vowel Variants Encoding

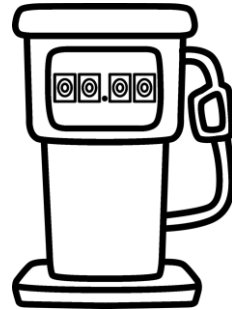

fuel

Tara West - Little Minds at Work

Vowel Variants Encoding

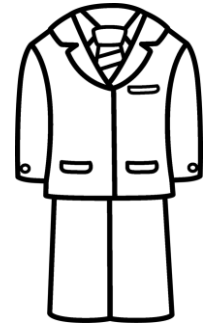

suit

Tara West - Little Minds at Work

Vowel Variants Encoding



coin

Tara West - Little Minds at Work

Vowel Variants Encoding

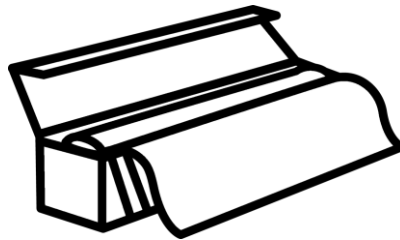

foil

Tara West - Little Minds at Work

Vowel Variants Encoding

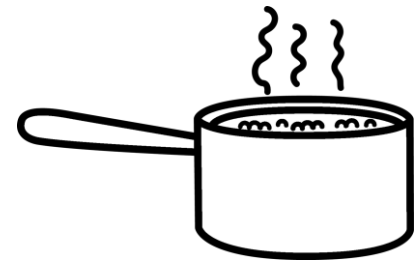

boil

Tara West - Little Minds at Work

Vowel Variants Encoding

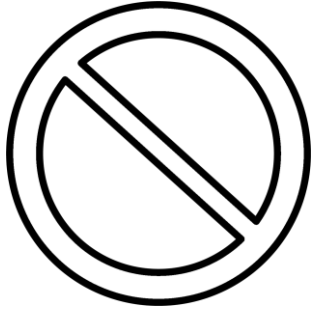

void

Tara West - Little Minds at Work

Vowel Variants Encoding

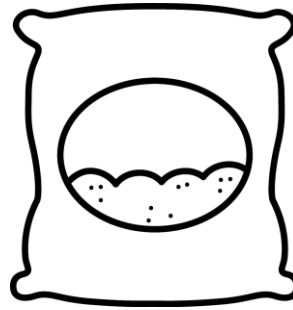

soil

Tara West - Little Minds at Work

Vowel Variants Encoding



boot

Tara West - Little Minds at Work

Vowel Variants Encoding



moon

Tara West - Little Minds at Work

Vowel Variants Encoding

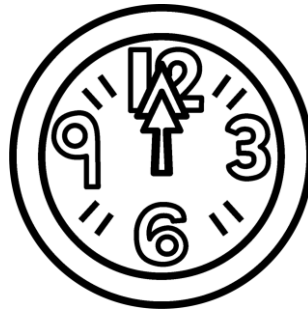

noon

Tara West - Little Minds at Work

Vowel Variants Encoding

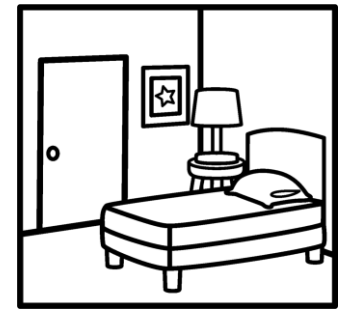

room

Tara West - Little Minds at Work

Vowel Variants Encoding



hoop

Tara West - Little Minds at Work

Vowel Variants Encoding

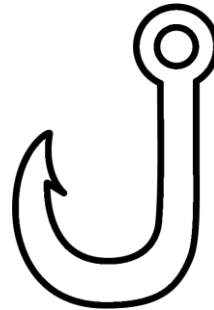

hook

Tara West - Little Minds at Work

Vowel Variants Encoding

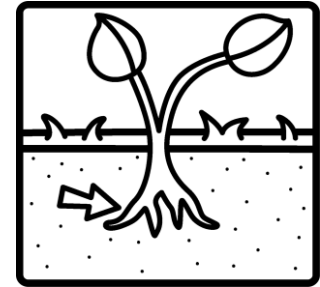

root

Tara West - Little Minds at Work

Vowel Variants Encoding



wood

Tara West - Little Minds at Work

Vowel Variants Encoding

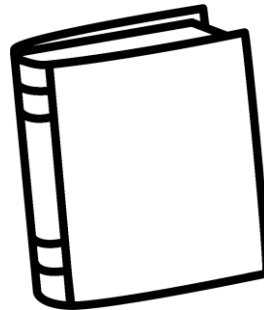

book

Tara West - Little Minds at Work

Vowel Variants Encoding

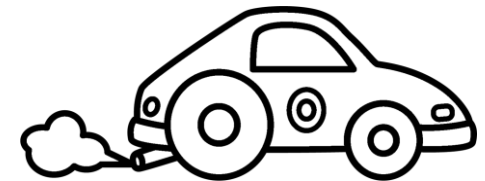

zoom

Tara West - Little Minds at Work

Vowel Variants Encoding



cook

Tara West - Little Minds at Work

Vowel Variants Encoding

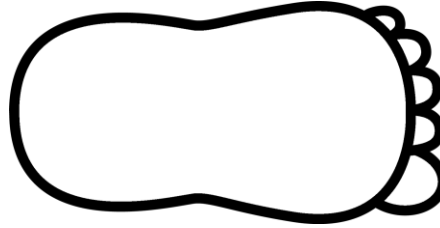

foot

Tara West - Little Minds at Work

Vowel Variants Encoding



look

Tara West - Little Minds at Work

Vowel Variants Encoding



hood

Tara West - Little Minds at Work







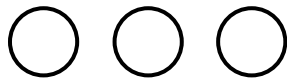
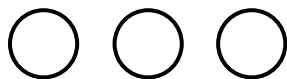
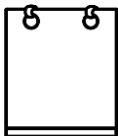
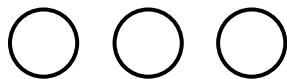
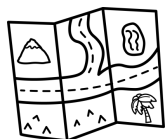
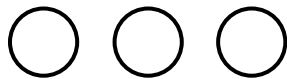
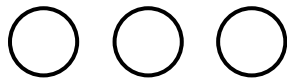
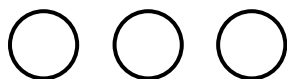
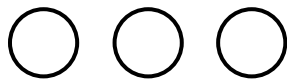
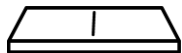

Say it.





Tap it.

Map it. Graph it.

Write it.

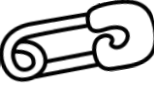

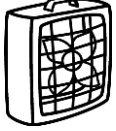
Say it.	Tap it.	Map it. Graph it.			Write it.
	○ ○ ○				
	○ ○ ○				
	○ ○ ○				
	○ ○ ○				
	○ ○ ○				
	○ ○ ○				
	○ ○ ○				
	○ ○ ○				

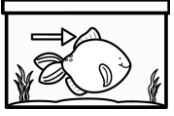
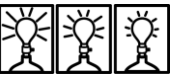
Say it.	Tap it.	Map it. Graph it.			Write it.
	○ ○ ○				
	○ ○ ○				
	○ ○ ○				
	○ ○ ○				
	○ ○ ○				
	○ ○ ○				
	○ ○ ○				
	○ ○ ○				







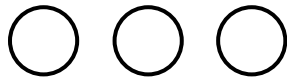
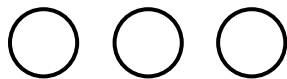
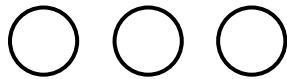
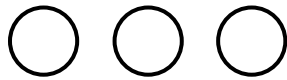
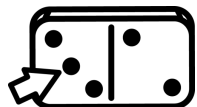
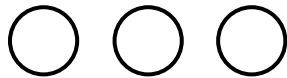
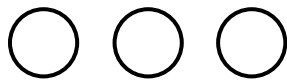
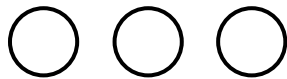
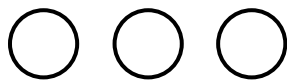

Say it.





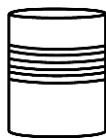



Tap it.









Map it. Graph it.

Write it.

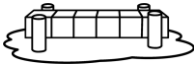

Say it.	Tap it.	Map it. Graph it.			Write it.
	○ ○ ○				
	○ ○ ○				
	○ ○ ○				
	○ ○ ○				
	○ ○ ○				
	○ ○ ○				
	○ ○ ○				
	○ ○ ○				

Say it.	Tap it.	Map it. Graph it.			Write it.
	○ ○ ○				
	○ ○ ○				
	○ ○ ○				
	○ ○ ○				
	○ ○ ○				
	○ ○ ○				
	○ ○ ○				
	○ ○ ○				

Say it.	Tap it.	Map it. Graph it.			Write it.
	○ ○ ○				
	○ ○ ○				
	○ ○ ○				
	○ ○ ○				
	○ ○ ○				
	○ ○ ○				
	○ ○ ○				
	○ ○ ○				







Say it.

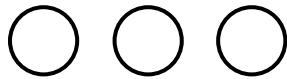
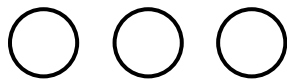
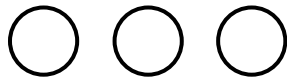
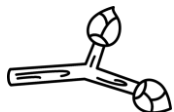
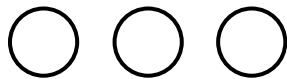
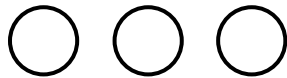
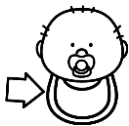
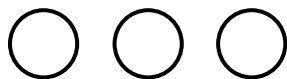
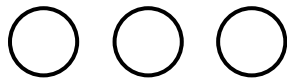
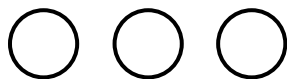

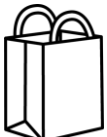

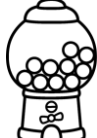
Tap it.

Map it. Graph it.

Write it.

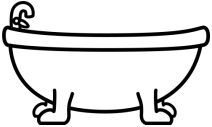

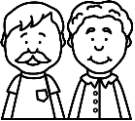
Say it.	Tap it.	Map it. Graph it.			Write it.
	○ ○ ○				
	○ ○ ○				
	○ ○ ○				
	○ ○ ○				
	○ ○ ○				
	○ ○ ○				
	○ ○ ○				
	○ ○ ○				

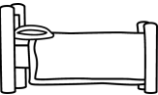
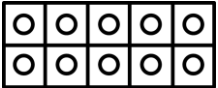
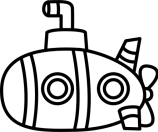
Say it.	Tap it.	Map it. Graph it.			Write it.
	○ ○ ○				
	○ ○ ○				
	○ ○ ○				
	○ ○ ○				
	○ ○ ○				
	○ ○ ○				
	○ ○ ○				
	○ ○ ○				







Say it.

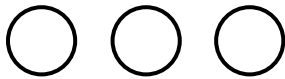
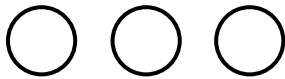
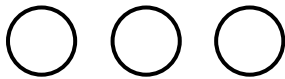
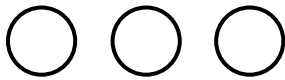
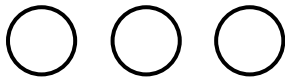
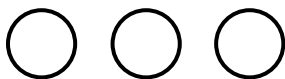
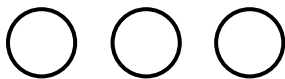
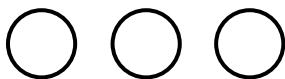



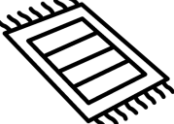

Tap it.

Map it. Graph it.

Write it.

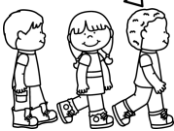

Say it.	Tap it.	Map it. Graph it.			Write it.
	○ ○ ○				
	○ ○ ○				
	○ ○ ○				
	○ ○ ○				
	○ ○ ○				
	○ ○ ○				
	○ ○ ○				
	○ ○ ○				

Say it.	Tap it.	Map it. Graph it.			Write it.
	○ ○ ○				
	○ ○ ○				
	○ ○ ○				
	○ ○ ○				
	○ ○ ○				
	○ ○ ○				
	○ ○ ○				
	○ ○ ○				

Say it.

Tap it.

Map it. Graph it.

Write it.

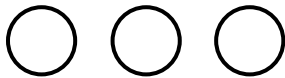
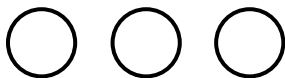
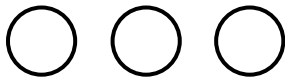
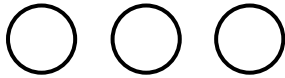
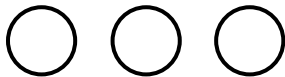
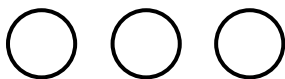
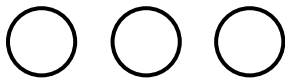
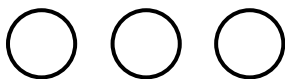

Say it.

Tap it.

Map it. Graph it.

Write it.

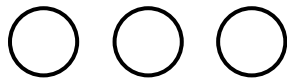
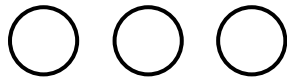
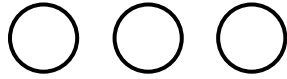
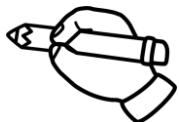
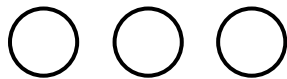
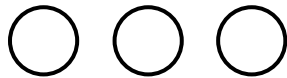
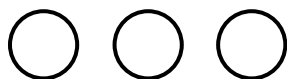
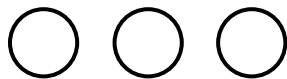
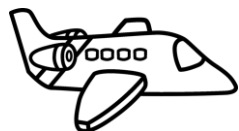
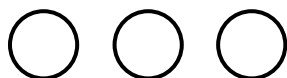







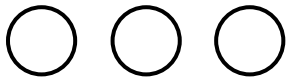
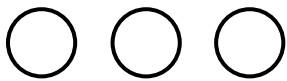
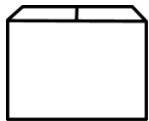
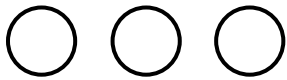
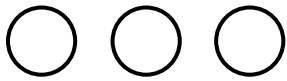
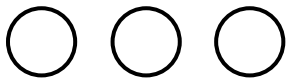
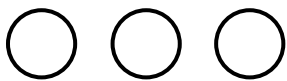
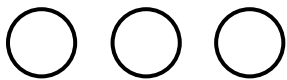
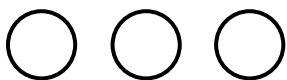
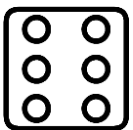

Say it.









Tap it.

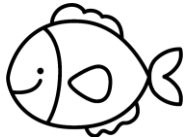







Map it. Graph it.

Write it.



Say it.	Tap it.	Map it. Graph it.			Write it.
	○ ○ ○				
	○ ○ ○				
	○ ○ ○				
	○ ○ ○				
	○ ○ ○				
	○ ○ ○				
	○ ○ ○				
	○ ○ ○				

Say it.	Tap it.	Map it. Graph it.			Write it.
	○ ○ ○				
	○ ○ ○				
	○ ○ ○				
	○ ○ ○				
	○ ○ ○				
	○ ○ ○				
	○ ○ ○				
	○ ○ ○				

Say it.	Tap it.	Map it. Graph it.			Write it.
	○ ○ ○				
	○ ○ ○				
	○ ○ ○				
	○ ○ ○				
	○ ○ ○				
	○ ○ ○				
	○ ○ ○				
	○ ○ ○				







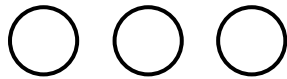
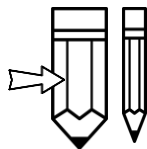
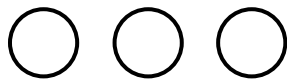
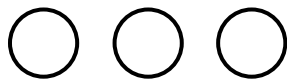
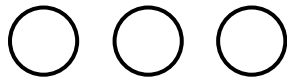
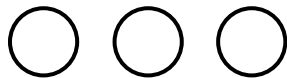
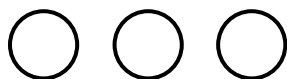
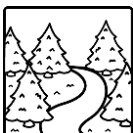
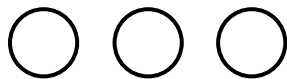
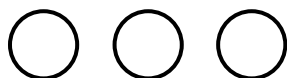

Say it.







Tap it.

Map it. Graph it.

Write it.

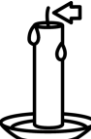

Say it.	Tap it.	Map it. Graph it.			Write it.
	○ ○ ○				
	○ ○ ○				
	○ ○ ○				
	○ ○ ○				
	○ ○ ○				
	○ ○ ○				
	○ ○ ○				
	○ ○ ○				

Say it.	Tap it.	Map it. Graph it.			Write it.
	○ ○ ○				
	○ ○ ○				
	○ ○ ○				
	○ ○ ○				
	○ ○ ○				
	○ ○ ○				
	○ ○ ○				
	○ ○ ○				

Say it.

Tap it.

Map it. Graph it.

Write it.

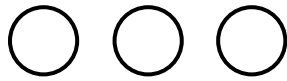
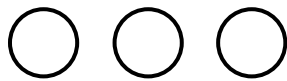
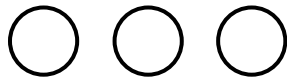
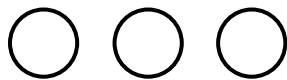
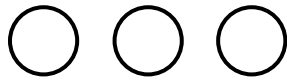
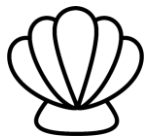
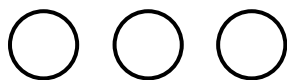
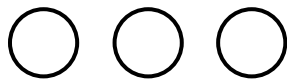
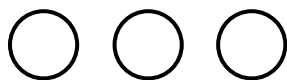

Say it.

Tap it.

Map it. Graph it.

Write it.

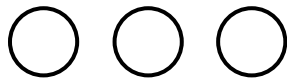
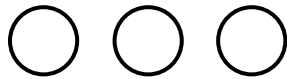
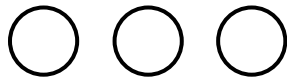
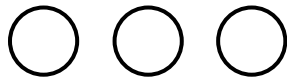
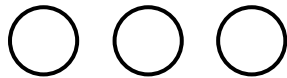
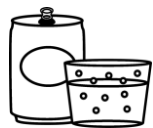
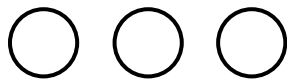
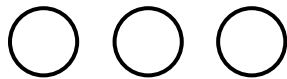
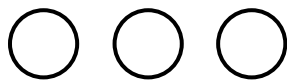







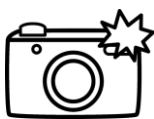

Say it.





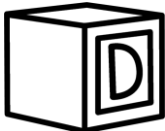
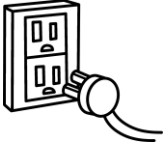

Tap it.

Map it. Graph it.

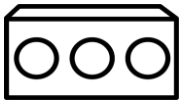
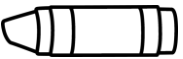
Write it.



Say it.	Tap it.	Map it. Graph it.				Write it.
	○ ○ ○ ○					
	○ ○ ○ ○					
	○ ○ ○ ○					
	○ ○ ○ ○					
	○ ○ ○ ○					
	○ ○ ○ ○					
	○ ○ ○ ○					
	○ ○ ○ ○					

Say it.	Tap it.	Map it. Graph it.				Write it.
	○ ○ ○ ○					
	○ ○ ○ ○					
	○ ○ ○ ○					
	○ ○ ○ ○					
	○ ○ ○ ○					
	○ ○ ○ ○					
	○ ○ ○ ○					
	○ ○ ○ ○					







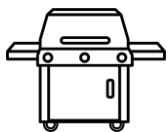
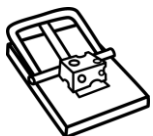

Say it.







Tap it.



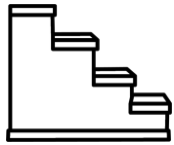





Map it. Graph it.

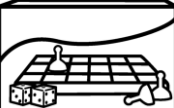







Write it.

















Say it.	Tap it.	Map it. Graph it.				Write it.
	○ ○ ○ ○					
	○ ○ ○ ○					
	○ ○ ○ ○					
	○ ○ ○ ○					
	○ ○ ○ ○					
	○ ○ ○ ○					
	○ ○ ○ ○					
	○ ○ ○ ○					



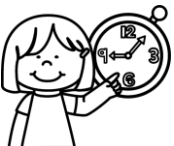

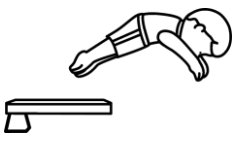

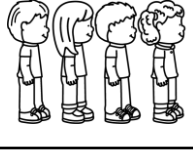

Say it.	Tap it.	Map it. Graph it.				Write it.
	○ ○ ○ ○					
	○ ○ ○ ○					
	○ ○ ○ ○					
	○ ○ ○ ○					
	○ ○ ○ ○					
	○ ○ ○ ○					
	○ ○ ○ ○					
	○ ○ ○ ○					



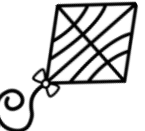

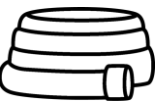

Say it.	Tap it.	Map it. Graph it.			Write it.
	○ ○ ○ (e)			e	
	○ ○ ○ (e)			e	
	○ ○ ○ (e)			e	
	○ ○ ○ (e)			e	
	○ ○ ○ (e)			e	
	○ ○ ○ (e)			e	
	○ ○ ○ (e)			e	
	○ ○ ○ (e)			e	



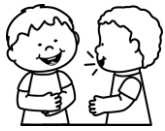

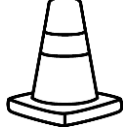

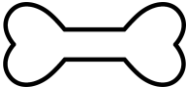

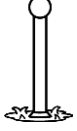
Say it.	Tap it.	Map it. Graph it.		Write it.
	○ ○ ○ (e)			e
	○ ○ ○ (e)			e
	○ ○ ○ (e)			e
	○ ○ ○ (e)			e
	○ ○ ○ (e)			e
	○ ○ ○ (e)			e
	○ ○ ○ (e)			e
	○ ○ ○ (e)			e









Say it.	Tap it.	Map it. Graph it.		Write it.
	○ ○ ○ (e)			e
	○ ○ ○ (e)			e
	○ ○ ○ (e)			e
	○ ○ ○ (e)			e
	○ ○ ○ (e)			e
	○ ○ ○ (e)			e
	○ ○ ○ (e)			e
	○ ○ ○ (e)			e





Say it.	Tap it.	Map it. Graph it.		Write it.
	○ ○ ○ e			e
	○ ○ ○ e			e
	○ ○ ○ e			e
	○ ○ ○ e			e
	○ ○ ○ e			e
	○ ○ ○ e			e
	○ ○ ○ e			e
	○ ○ ○ e			e

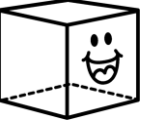



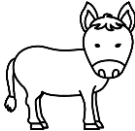
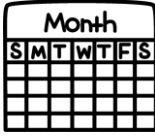
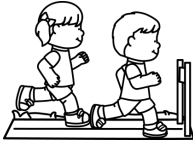



Say it.	Tap it.	Map it. Graph it.		Write it.
	○ ○ ○ (e)			e
	○ ○ ○ (e)			e
	○ ○ ○ (e)			e
	○ ○ ○ (e)			e
	○ ○ ○ (e)			e
	○ ○ ○ (e)			e
	○ ○ ○ (e)			e
	○ ○ ○ (e)			e









Say it.	Tap it.	Map it. Graph it.			Write it.
	○ ○ ○ (e)			e	
	○ ○ ○ (e)			e	
	○ ○ ○ (e)			e	
	○ ○ ○ (e)			e	
	○ ○ ○ (e)			e	
	○ ○ ○ (e)			e	
	○ ○ ○ (e)			e	
	○ ○ ○ (e)			e	

Say it.	Tap it.	Map it. Graph it.			Write it.
	○ ○ ○ (e)			e	
	○ ○ ○ (e)			e	
	○ ○ ○ (e)			e	
	○ ○ ○ (e)			e	
	○ ○ ○ (e)			e	
	○ ○ ○ (e)			e	
	○ ○ ○ (e)			e	
	○ ○ ○ (e)			e	

Say it.	Tap it.	Map it. Graph it.		Write it.
	○ ○ ○ (e)			e
	○ ○ ○ (e)			e
	○ ○ ○ (e)			e
	○ ○ ○ (e)			e
	○ ○ ○ (e)			e
	○ ○ ○ (e)			e
	○ ○ ○ (e)			e
	○ ○ ○ (e)			e

Say it.	Tap it.	Map it. Graph it.			Write it.
	○ ○ ○ (e)			e	
	○ ○ ○ (e)			e	
	○ ○ ○ (e)			e	
	○ ○ ○ (e)			e	
	○ ○ ○ (e)			e	
	○ ○ ○ (e)			e	
	○ ○ ○ (e)			e	
	○ ○ ○ (e)			e	

Say it.	Tap it.	Map it. Graph it.				Write it.
	○ ○ ○ ○					
	○ ○ ○ ○					
	○ ○ ○ ○					
	○ ○ ○ ○					
	○ ○ ○ ○					
	○ ○ ○ ○					
	○ ○ ○ ○					
	○ ○ ○ ○					

Say it.	Tap it.	Map it. Graph it.				Write it.
	○ ○ ○ ○					
	○ ○ ○ ○					
	○ ○ ○ ○					
	○ ○ ○ ○					
	○ ○ ○ ○					
	○ ○ ○ ○					
	○ ○ ○ ○					
	○ ○ ○ ○					







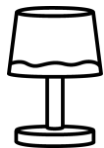
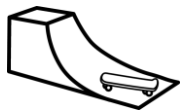
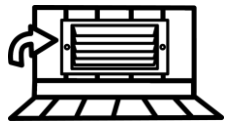

Say it.

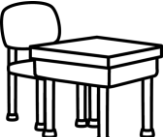







Tap it.

Map it. Graph it.

Write it.



Say it.	Tap it.	Map it. Graph it.				Write it.
	○ ○ ○ ○					
	○ ○ ○ ○					
	○ ○ ○ ○					
	○ ○ ○ ○					
	○ ○ ○ ○					
	○ ○ ○ ○					
	○ ○ ○ ○					
	○ ○ ○ ○					

Say it.	Tap it.	Map it. Graph it.			Write it.
	○ ○ ○				
	○ ○ ○				
	○ ○ ○				
	○ ○ ○				
	○ ○ ○				
	○ ○ ○				
	○ ○ ○				
	○ ○ ○				

Say it.

Tap it.

Map it. Graph it.

Write it.

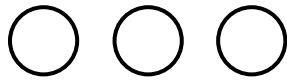
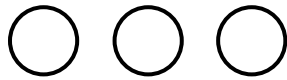
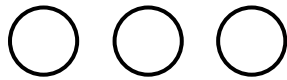
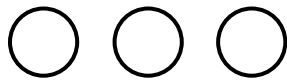
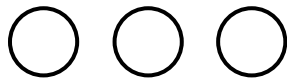
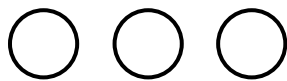
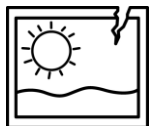
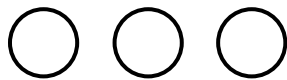
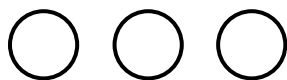







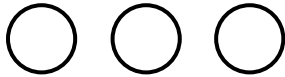
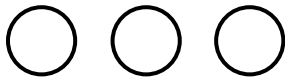
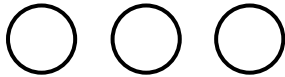
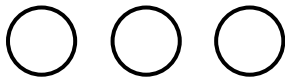
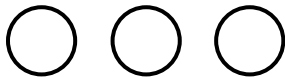
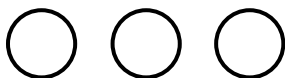
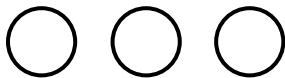
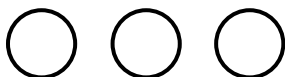

Say it.





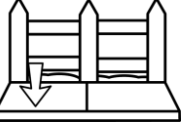

Tap it.





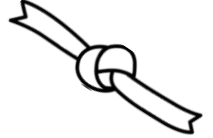

Map it. Graph it.



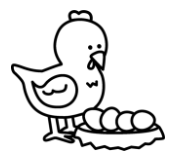
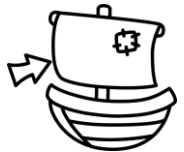



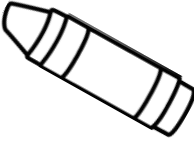
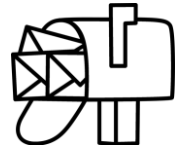

Write it.

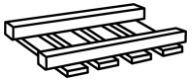

Say it.	Tap it.	Map it. Graph it.			Write it.
	○ ○ ○				
	○ ○ ○				
	○ ○ ○				
	○ ○ ○				
	○ ○ ○				
	○ ○ ○				
	○ ○ ○				
	○ ○ ○				

Say it.	Tap it.	Map it. Graph it.			Write it.
	○ ○ ○				
	○ ○ ○				
	○ ○ ○				
	○ ○ ○				
	○ ○ ○				
	○ ○ ○				
	○ ○ ○				
	○ ○ ○				

Say it.	Tap it.	Map it. Graph it.			Write it.
	○ ○ ○				
	○ ○ ○				
	○ ○ ○				
	○ ○ ○				
	○ ○ ○				
	○ ○ ○				
	○ ○ ○				
	○ ○ ○				

Say it.	Tap it.	Map it. Graph it.			Write it.
	○ ○ ○				
	○ ○ ○				
	○ ○ ○				
	○ ○ ○				
	○ ○ ○				
	○ ○ ○				
	○ ○ ○				
	○ ○ ○				

Say it.

Tap it.

Map it. Graph it.

Write it.

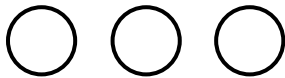
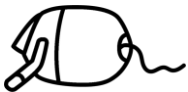
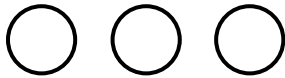
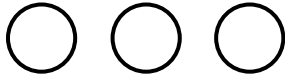
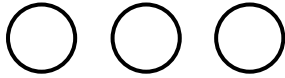
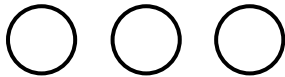
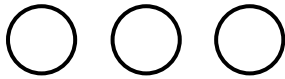
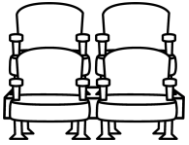
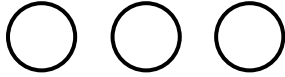
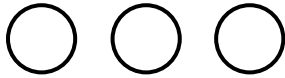





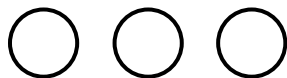
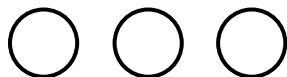
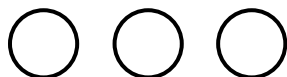
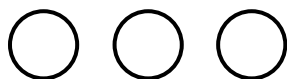
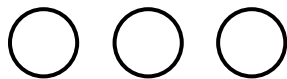
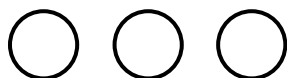

Say it.

Tap it.

Map it. Graph it.

Write it.

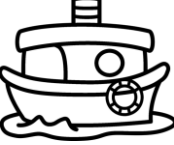
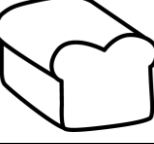
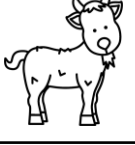
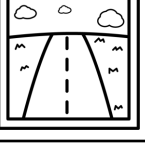

Say it.	Tap it.	Map it. Graph it.			Write it.
	○ ○ ○				
	○ ○ ○				
	○ ○ ○				
	○ ○ ○				
	○ ○ ○				
	○ ○ ○				
	○ ○ ○				
	○ ○ ○				

Say it.

Tap it.

Map it. Graph it.

Write it.

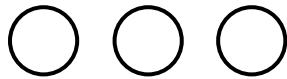
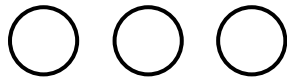
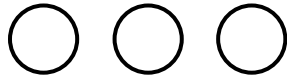
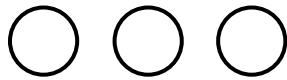
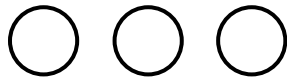
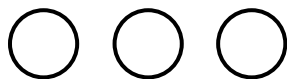
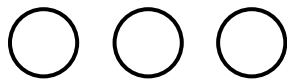
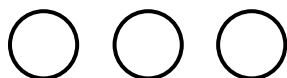







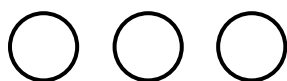
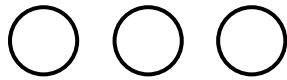
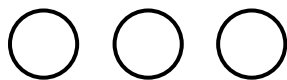
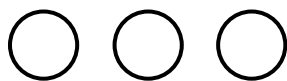
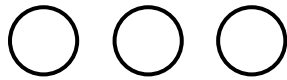
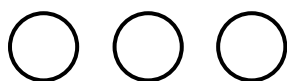
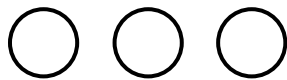
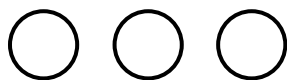
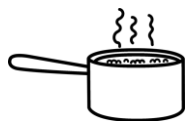

Say it.

Tap it.

Map it. Graph it.

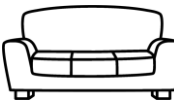
Write it.



Say it.	Tap it.	Map it. Graph it.			Write it.
	○ ○ ○				
	○ ○ ○				
	○ ○ ○				
	○ ○ ○				
	○ ○ ○				
	○ ○ ○				
	○ ○ ○				
	○ ○ ○				

Say it.

Tap it.

Map it. Graph it.

Write it.

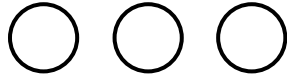
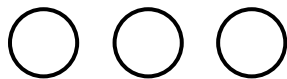
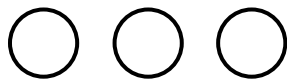
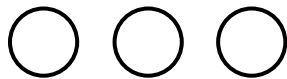
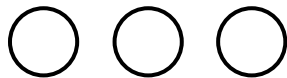
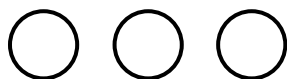
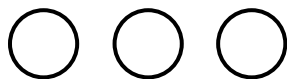
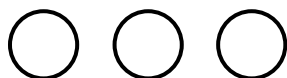

Say it.

Tap it.

Map it. Graph it.

Write it.

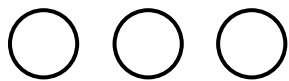
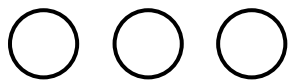
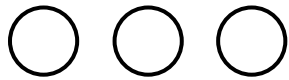
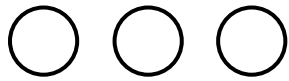
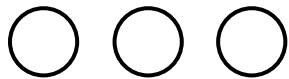
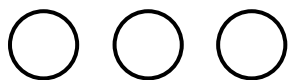
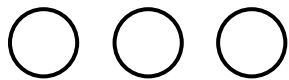
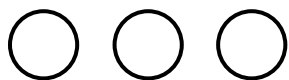

Name:

Illustrate your story.

Say, tap, map, and graph the story words.

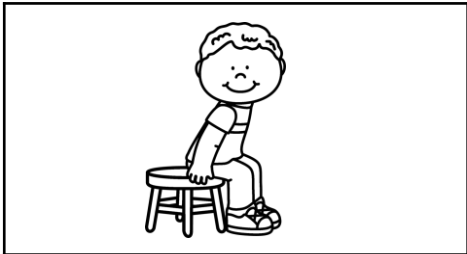

Three circles arranged horizontally above three empty rectangular boxes arranged horizontally, intended for graphing the words from the illustration.

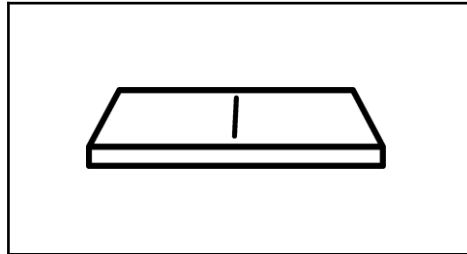

Three circles arranged horizontally above three empty rectangular boxes arranged horizontally, intended for graphing the words from the illustration.

Use the words in your story.

Three sets of handwriting lines, each consisting of a solid top line, a dashed middle line, and a solid bottom line, for practicing writing words from the story.

Name:

Say, tap, map, and graph the story words.

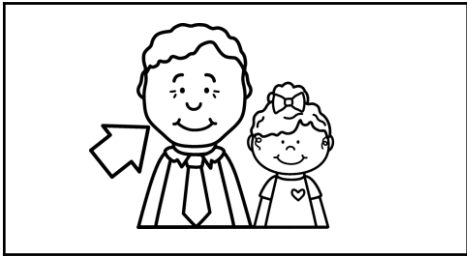

○	○	○

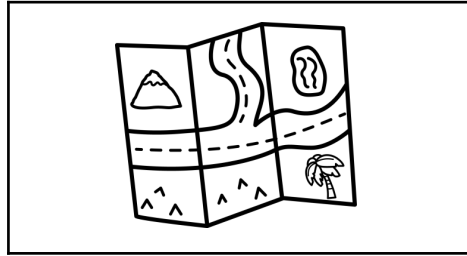

○	○	○

Illustrate your story.

Use the words in your story.

Name:

Say, tap, map, and graph the story words.

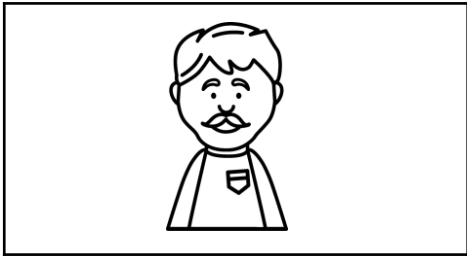

Three circles above three empty rectangular boxes for graphing.

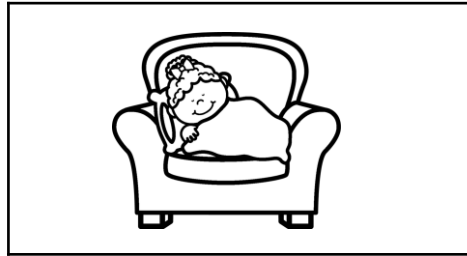

Three circles above three empty rectangular boxes for graphing.

Illustrate your story.

Use the words in your story.

Four sets of handwriting lines, each consisting of a solid top line, a dashed middle line, and a solid bottom line.

Name:

Say, tap, map, and graph the story words.

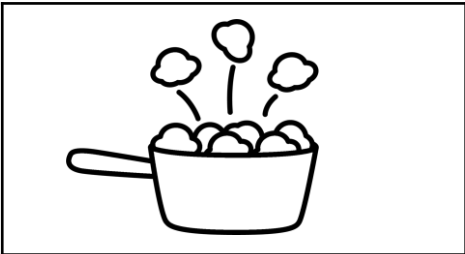

Three circles above three empty rectangular boxes for graphing.

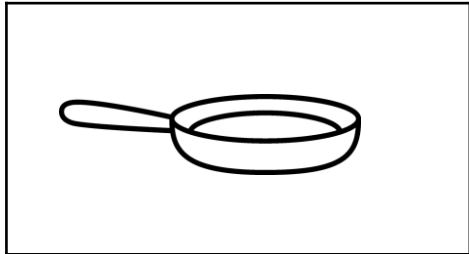

Three circles above three empty rectangular boxes for graphing.

Illustrate your story.

Use the words in your story.

Three sets of handwriting lines, each consisting of a solid top line, a dashed middle line, and a solid bottom line.

Name:

Illustrate your story.

Say, tap, map, and graph the story words.

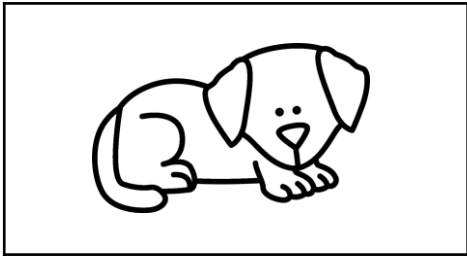

Three circles above three empty boxes for graphing.



Three circles above three empty boxes for graphing.

Use the words in your story.

Four sets of handwriting lines, each consisting of a solid top line, a dashed middle line, and a solid bottom line.

Name:

Say, tap, map, and graph the story words.

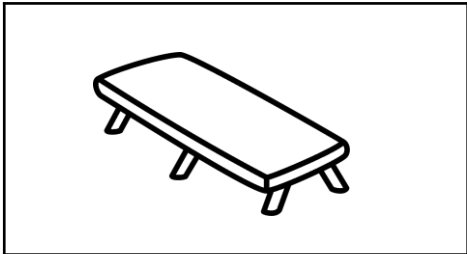

Three circles arranged horizontally above three empty rectangular boxes arranged horizontally, for graphing the word 'table'.

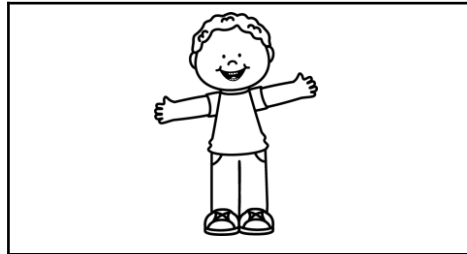

Three circles arranged horizontally above three empty rectangular boxes arranged horizontally, for graphing the word 'boy'.

Illustrate your story.

Use the words in your story.

Four sets of handwriting lines, each consisting of a solid top line, a dashed middle line, and a solid bottom line.

Name:

Say, tap, map, and graph the story words.

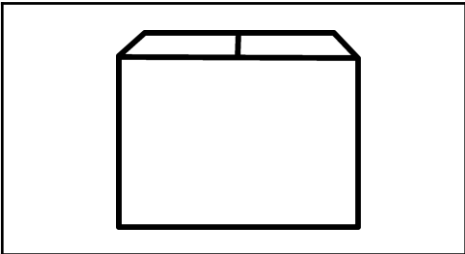

Three circles arranged horizontally above a row of three empty rectangular boxes, used for graphing the words.



Three circles arranged horizontally above a row of three empty rectangular boxes, used for graphing the words.

Illustrate your story.

Use the words in your story.

Four sets of handwriting lines, each consisting of a solid top line, a dashed middle line, and a solid bottom line, for practicing writing the words from the story.

Name:

Illustrate your story.

Say, tap, map, and graph the story words.

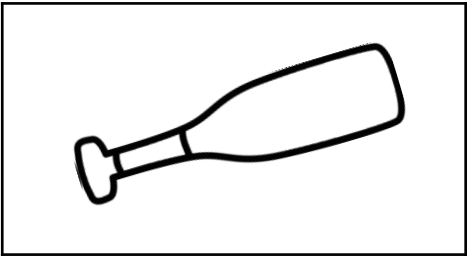

○	○	○

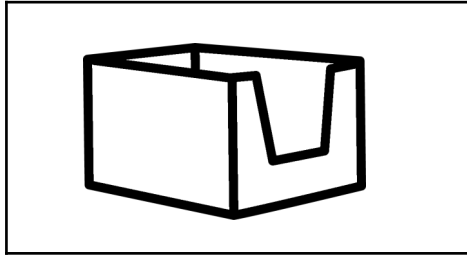

○	○	○

Use the words in your story.

Handwriting practice lines consisting of three sets of solid top and bottom lines with a dashed middle line.

Name:

Illustrate your story.

Say, tap, map, and graph the story words.

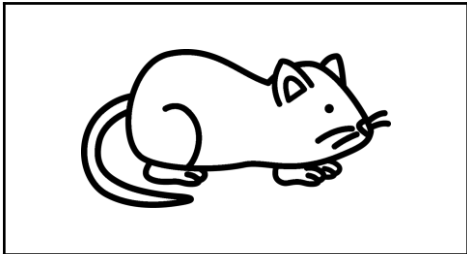

Three circles above three empty rectangular boxes, used for graphing the word 'cat'.

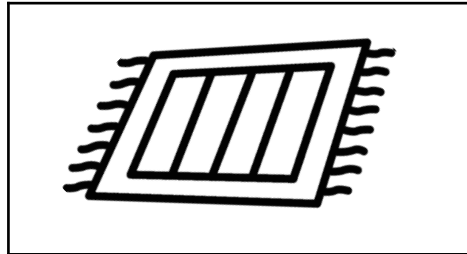

Three circles above three empty rectangular boxes, used for graphing the word 'rug'.

Use the words in your story.

Four sets of handwriting lines, each consisting of a solid top line, a dashed middle line, and a solid bottom line.

Name:

Illustrate your story.

Say, tap, map, and graph the story words.



Three circles arranged horizontally above three empty rectangular boxes arranged horizontally, for graphing the words in the first illustration.

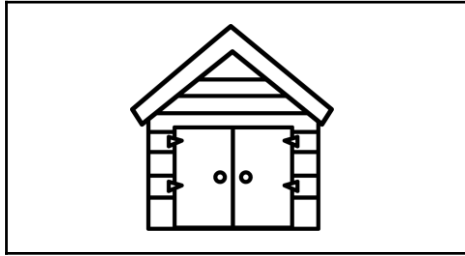

Three circles arranged horizontally above three empty rectangular boxes arranged horizontally, for graphing the words in the second illustration.

Use the words in your story.

Four sets of handwriting lines, each consisting of a solid top line, a dashed middle line, and a solid bottom line, for writing the story words.

Name:

Say, tap, map, and graph the story words.



Three circles above three empty rectangular boxes, used for graphing the words in the first illustration.

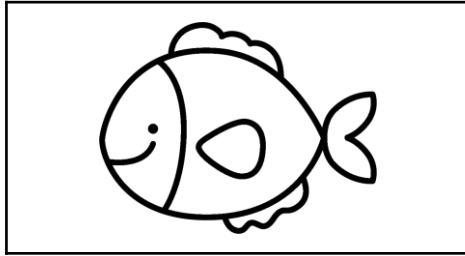

Three circles above three empty rectangular boxes, used for graphing the words in the second illustration.

Illustrate your story.

Use the words in your story.

Four sets of handwriting lines, each consisting of a solid top line, a dashed middle line, and a solid bottom line.

Name:

Illustrate your story.

Say, tap, map, and graph the story words.

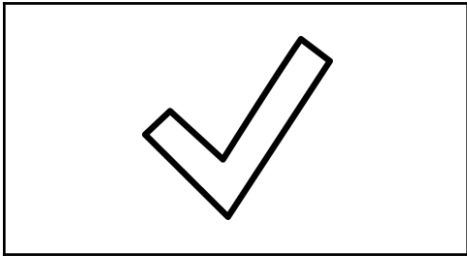

○	○	○

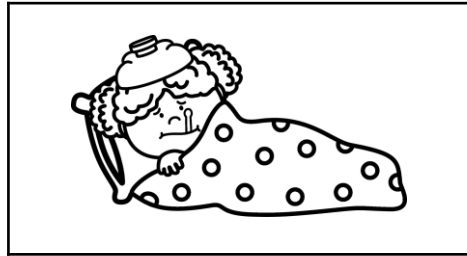

○	○	○

Use the words in your story.

Handwriting practice lines consisting of three sets of solid top and bottom lines with a dashed middle line.

Name:

Illustrate your story.

Say, tap, map, and graph the story words.

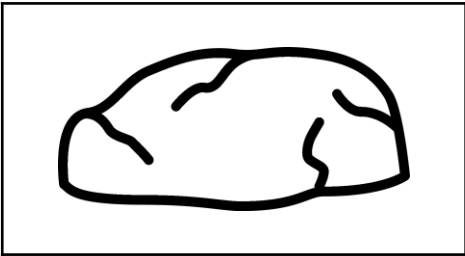

Three circles arranged horizontally above a row of three empty rectangular boxes, intended for graphing the letters of the word 'bread'.

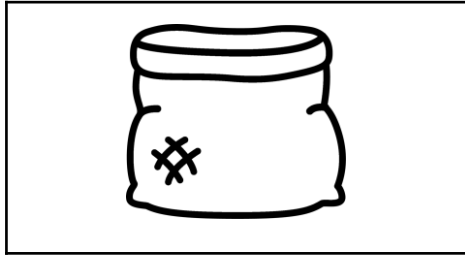

Three circles arranged horizontally above a row of three empty rectangular boxes, intended for graphing the letters of the word 'flour'.

Use the words in your story.

Four sets of handwriting lines, each consisting of a solid top line, a dashed middle line, and a solid bottom line, for practicing writing words.

Name:

Illustrate your story.

Say, tap, map, and graph the story words.

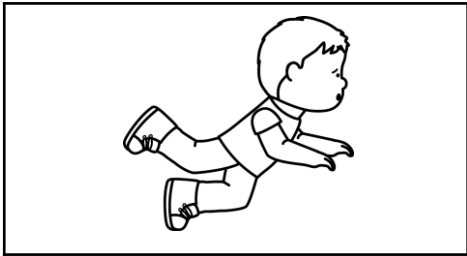

Three circles above three empty rectangular boxes, used for graphing the words in the first illustration.

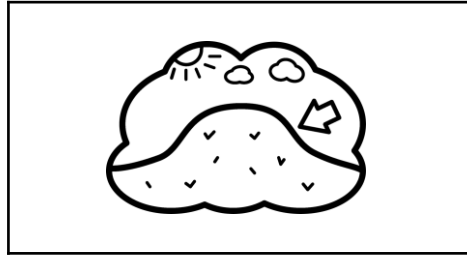

Three circles above three empty rectangular boxes, used for graphing the words in the second illustration.

Use the words in your story.

Four sets of handwriting lines, each consisting of a solid top line, a dashed middle line, and a solid bottom line.

Name: _____

Say, tap, map, and graph the story words.



○ ○ ○

--	--	--

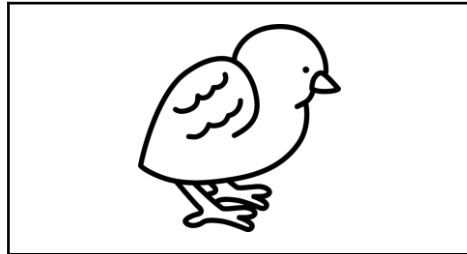

○ ○ ○

--	--	--

Illustrate your story.

Use the words in your story.

Name:

Illustrate your story.

Say, tap, map, and graph the story words.

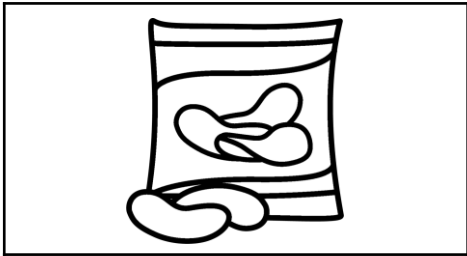

Three circles above three empty rectangular boxes for graphing.

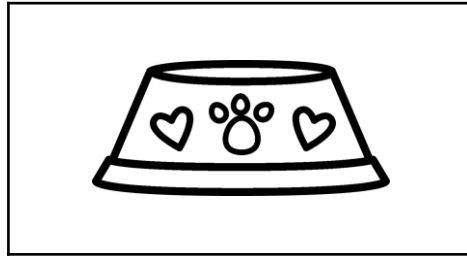

Three circles above three empty rectangular boxes for graphing.

Use the words in your story.

Four sets of handwriting lines, each consisting of a solid top line, a dashed middle line, and a solid bottom line.

Name:

Say, tap, map, and graph the story words.



○	○	○

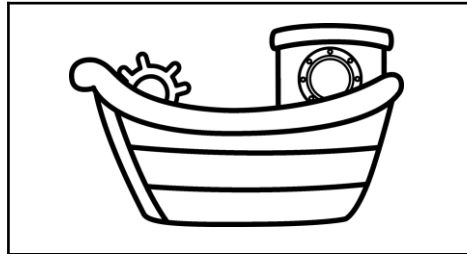

○	○	○

Illustrate your story.

Use the words in your story.

Handwriting practice lines consisting of three sets of solid top and bottom lines with a dashed middle line.

Name:

Say, tap, map, and graph the story words.

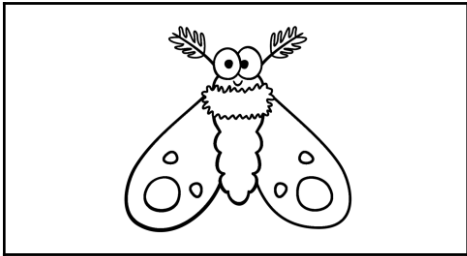

○	○	○

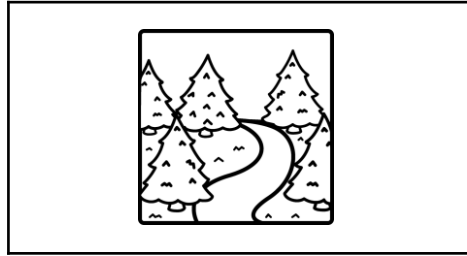

○	○	○

Illustrate your story.

Use the words in your story.

Handwriting practice lines consisting of three sets of solid top and bottom lines with a dashed middle line.

Name: _____

Illustrate your story.

Say, tap, map, and graph the story words.



○ ○ ○ (e)

--	--	--

e

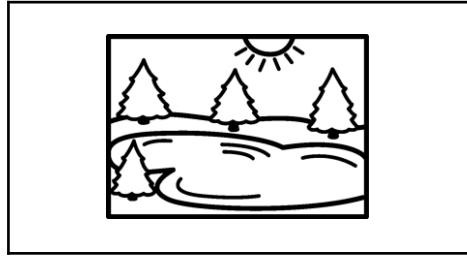

○ ○ ○ (e)

--	--	--

e

Use the words in your story.

Name: _____

Illustrate your story.

Say, tap, map, and graph the story words.

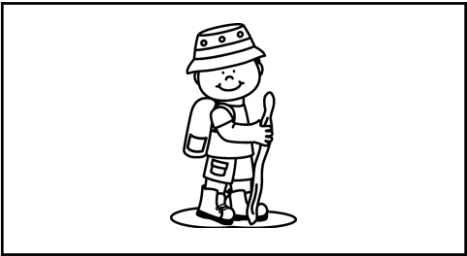

○ ○ ○ (e)
□ □ □ e

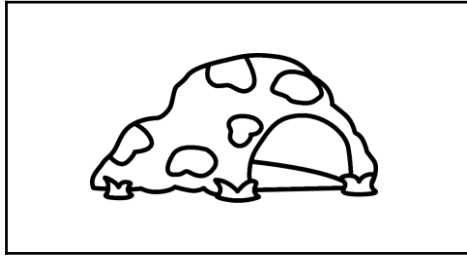

○ ○ ○ (e)
□ □ □ e

Use the words in your story.

Name:

Illustrate your story.

Say, tap, map, and graph the story words.

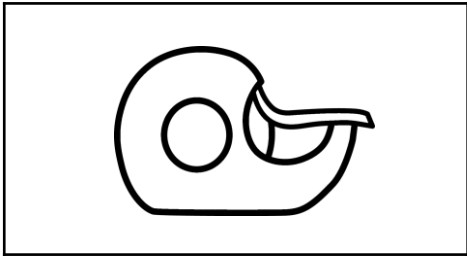

○ ○ ○ (e)
□ □ □ e

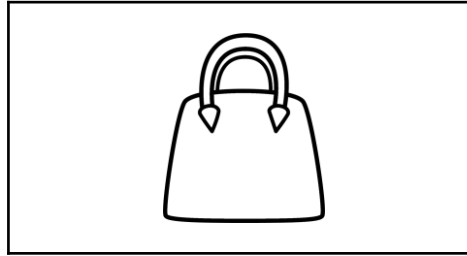

○ ○ ○ (e)
□ □ □ e

Use the words in your story.

Handwriting practice lines consisting of three sets of solid top and bottom lines with a dashed middle line.

Name: _____

Illustrate your story.

Say, tap, map, and graph the story words.



○ ○ ○ (e)
□ □ □ (e)

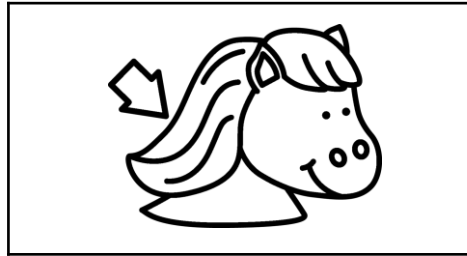

○ ○ ○ (e)
□ □ □ (e)

Use the words in your story.

Name: _____

Illustrate your story.

Say, tap, map, and graph the story words.

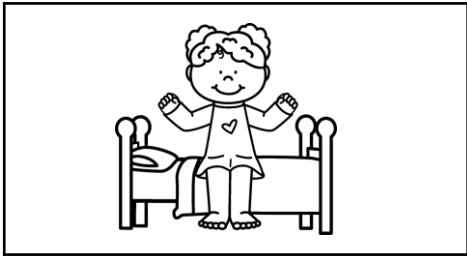

○ ○ ○ (e)

--	--	--

e

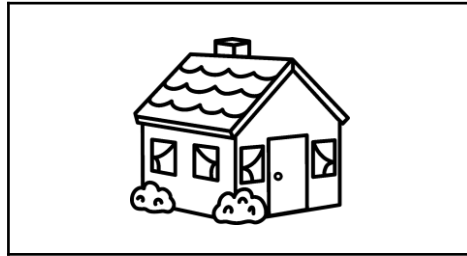

○ ○ ○ (e)

--	--	--

e

Use the words in your story.

Name: _____

Illustrate your story.

Say, tap, map, and graph the story words.

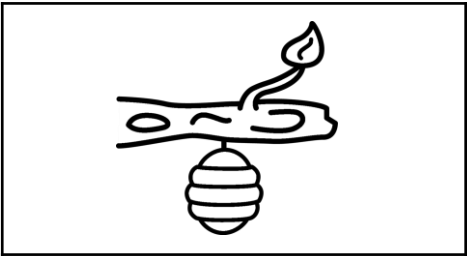

○ ○ ○ (e)
□ □ □ (e)

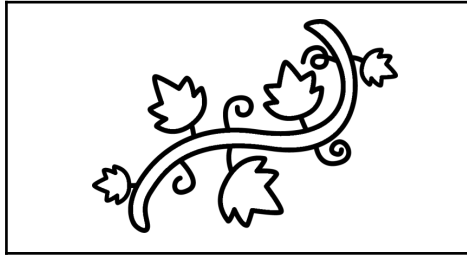

○ ○ ○ (e)
□ □ □ (e)

Use the words in your story.

Name: _____

Illustrate your story.

Say, tap, map, and graph the story words.

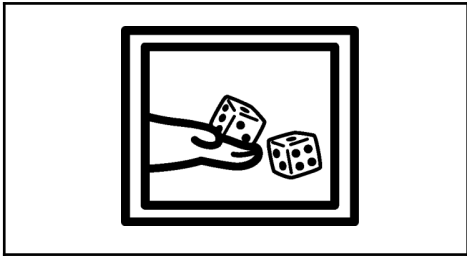

○ ○ ○ (e)

--	--	--

e



○ ○ ○ (e)

--	--	--

e

Use the words in your story.

Name: _____

Illustrate your story.

Say, tap, map, and graph the story words.

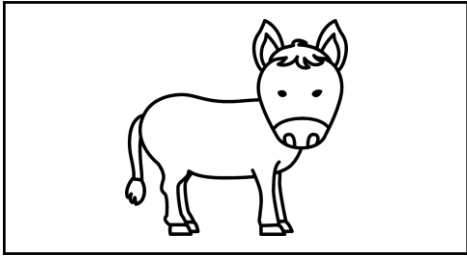

e

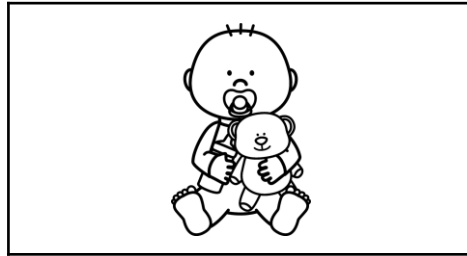

e

Use the words in your story.

Name: _____

Illustrate your story.

Say, tap, map, and graph the story words.

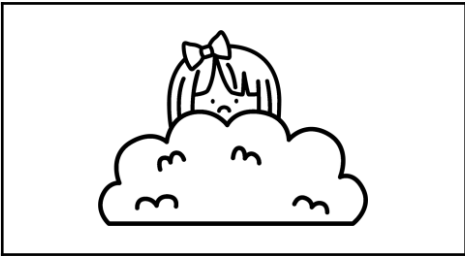

○ ○ ○ (e)
□ □ □ e

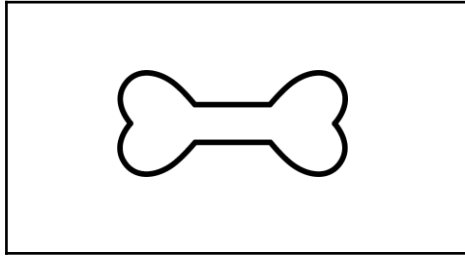

○ ○ ○ (e)
□ □ □ e

Use the words in your story.

Name: _____

Illustrate your story.

Say, tap, map, and graph the story words.

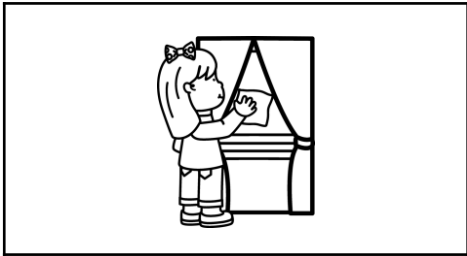

○ ○ ○ (e)
□ □ □ e

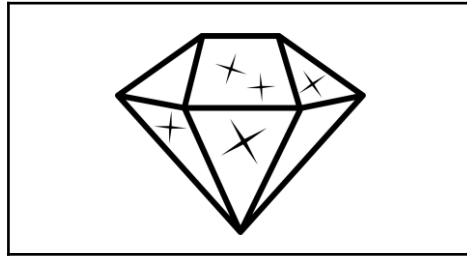

○ ○ ○ (e)
□ □ □ e

Use the words in your story.

Name:

Say, tap, map, and graph the story words.

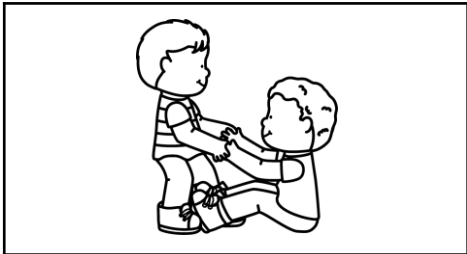

○ ○ ○ ○

--	--	--	--

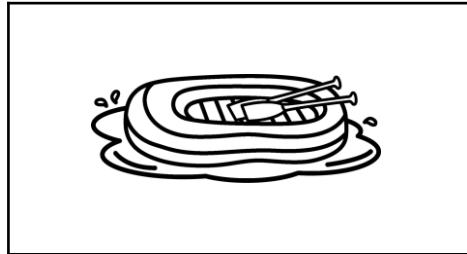

○ ○ ○ ○

--	--	--	--

Illustrate your story.

Use the words in your story.

Handwriting practice lines consisting of solid top and bottom lines with a dashed middle line. There are four sets of these lines provided for writing.

Name:

Illustrate your story.

Say, tap, map, and graph the story words.

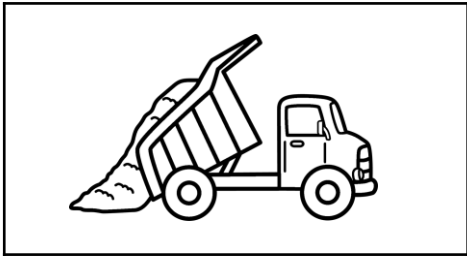

Four circles in a row above four empty rectangular boxes in a row.



Four circles in a row above four empty rectangular boxes in a row.

Use the words in your story.

Four sets of handwriting lines, each consisting of a solid top line, a dashed middle line, and a solid bottom line.

Name: _____

Illustrate your story.

Say, tap, map, and graph the story words.



○ ○ ○ ○

--	--	--	--

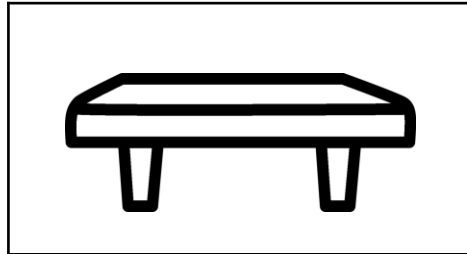

○ ○ ○ ○

--	--	--	--

Use the words in your story.

Name:

Illustrate your story.

Say, tap, map, and graph the story words.

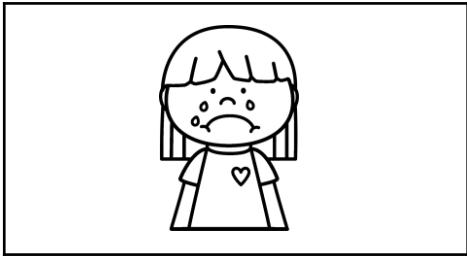

○ ○ ○ ○

--	--	--	--



○ ○ ○ ○

--	--	--	--

Use the words in your story.

Name:

Say, tap, map, and graph the story words.

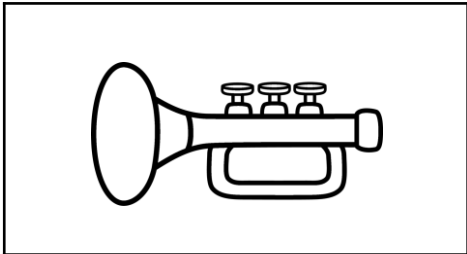

Three circles above three empty rectangular boxes for graphing.

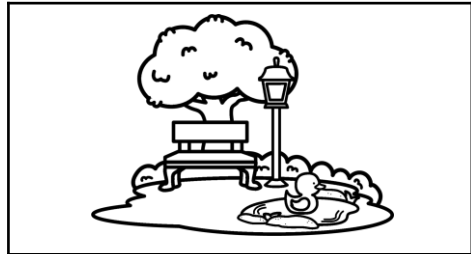

Three circles above three empty rectangular boxes for graphing.

Illustrate your story.

Use the words in your story.

Three sets of handwriting lines, each consisting of a solid top line, a dashed middle line, and a solid bottom line.

Name: _____

Say, tap, map, and graph the story words.

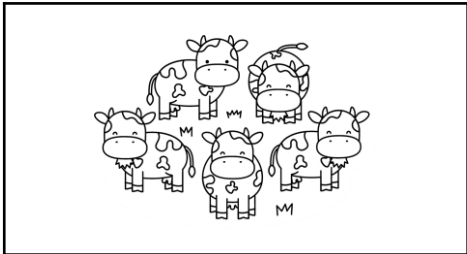

○	○	○

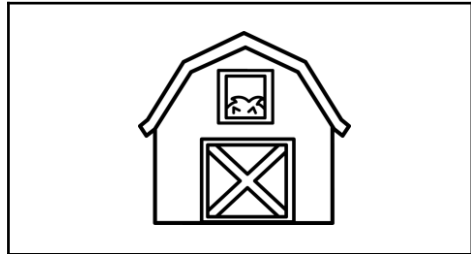

○	○	○

Illustrate your story.

Use the words in your story.

Name:

Say, tap, map, and graph the story words.

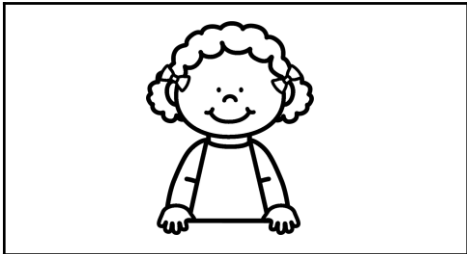

Three circles above three empty rectangular boxes, used for graphing the words.



Three circles above three empty rectangular boxes, used for graphing the words.

Illustrate your story.

Use the words in your story.

Handwriting practice lines consisting of solid top and bottom lines with a dashed middle line.

Name:

Say, tap, map, and graph the story words.

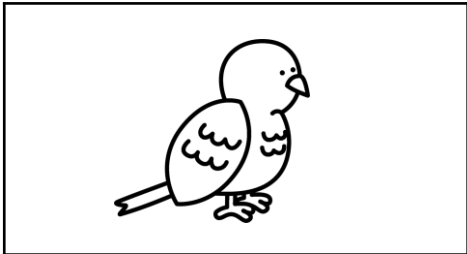

Three circles arranged horizontally above three empty rectangular boxes arranged horizontally, intended for graphing the story words.

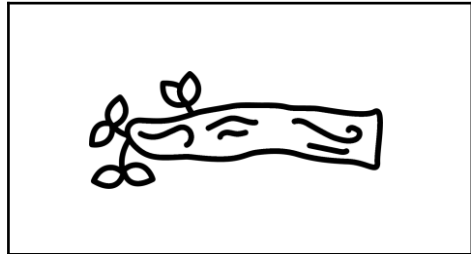

Three circles arranged horizontally above three empty rectangular boxes arranged horizontally, intended for graphing the story words.

Illustrate your story.

Use the words in your story.

Four sets of handwriting lines, each consisting of a solid top line, a dashed middle line, and a solid bottom line.

Name:

Illustrate your story.

Say, tap, map, and graph the story words.



○ ○ ○

--	--	--

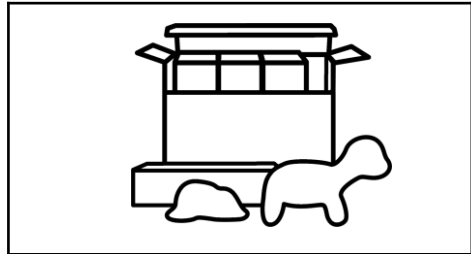

○ ○ ○

--	--	--

Use the words in your story.

Name:

Say, tap, map, and graph the story words.

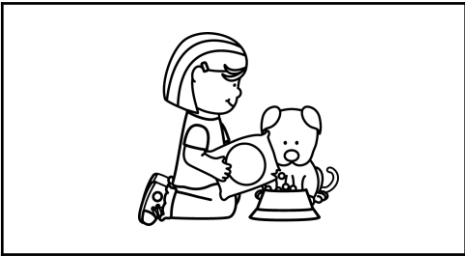

○ ○ ○

--	--	--

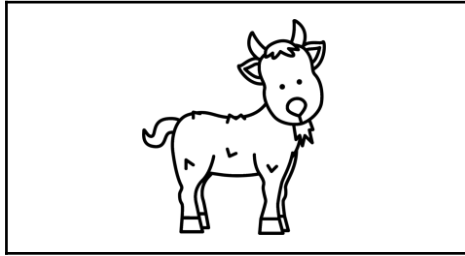

○ ○ ○

--	--	--

Illustrate your story.

Use the words in your story.

Name:

Say, tap, map, and graph the story words.

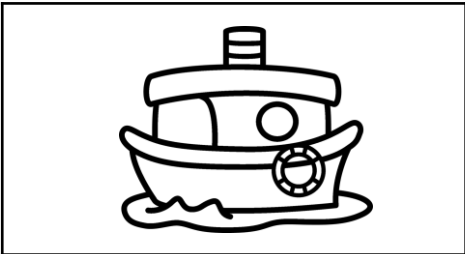

Three circles above three empty rectangular boxes, used for graphing the words 'boat'.

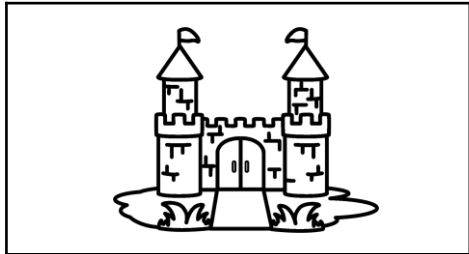

Three circles above three empty rectangular boxes, used for graphing the words 'castle'.

Illustrate your story.

Use the words in your story.

Four sets of handwriting lines, each consisting of a solid top line, a dashed middle line, and a solid bottom line.

Name:

Say, tap, map, and graph the story words.

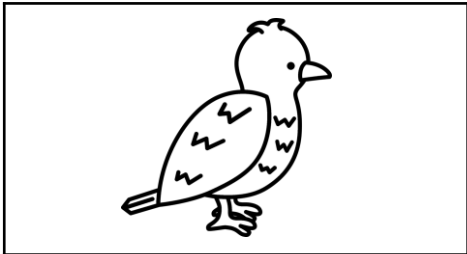

Three circles above three empty rectangular boxes, used for graphing the bird's name.

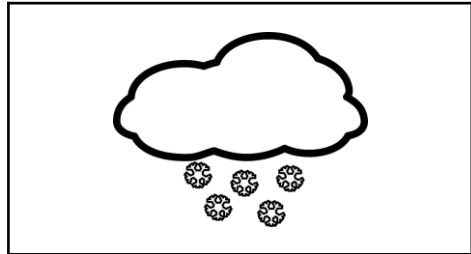

Three circles above three empty rectangular boxes, used for graphing the cloud/rain name.

Illustrate your story.

Use the words in your story.

Four sets of handwriting lines, each consisting of a solid top line, a dashed middle line, and a solid bottom line.

Name:

Say, tap, map, and graph the story words.

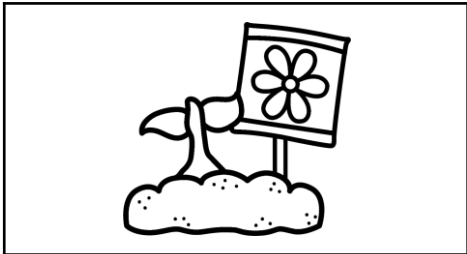

Three circles above three empty rectangular boxes, used for graphing the words from the first illustration.

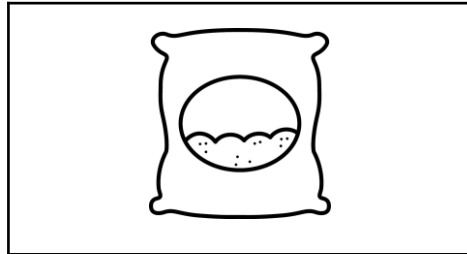

Three circles above three empty rectangular boxes, used for graphing the words from the second illustration.

Illustrate your story.

Use the words in your story.

Three sets of handwriting lines, each consisting of a solid top line, a dashed middle line, and a solid bottom line.

Name:

Say, tap, map, and graph the story words.

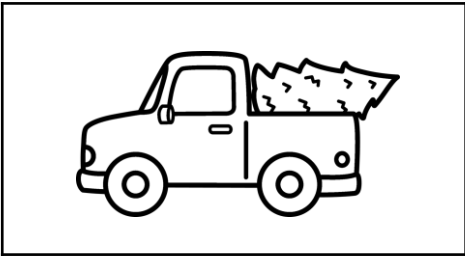

Three circles above three empty rectangular boxes for graphing.



Three circles above three empty rectangular boxes for graphing.

Illustrate your story.

Use the words in your story.

Four sets of handwriting lines, each consisting of a solid top line, a dashed middle line, and a solid bottom line.

Name: _____

Say, tap, map, and graph the story words.



○	○	○

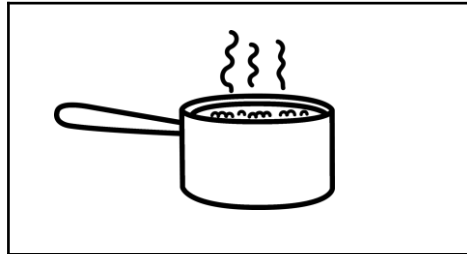

○	○	○

Illustrate your story.

Use the words in your story.

Name: _____

Illustrate your story.

Say, tap, map, and graph the story words.

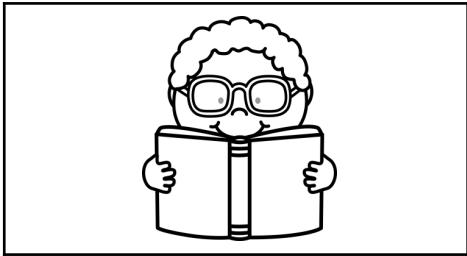

Three circles above three empty rectangular boxes, used for graphing the words in the first illustration.

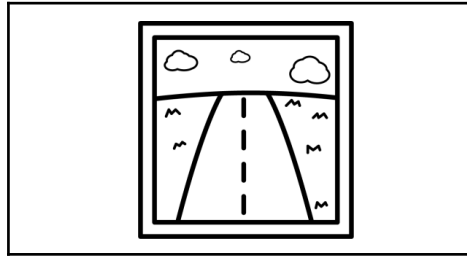

Three circles above three empty rectangular boxes, used for graphing the words in the second illustration.

Use the words in your story.

Four sets of handwriting lines, each consisting of a solid top line, a dashed middle line, and a solid bottom line.

Name: _____

Directions: Say, tap, map, and graph the words.

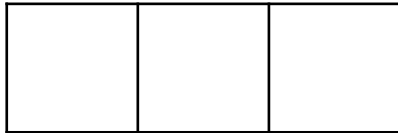
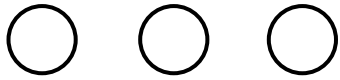
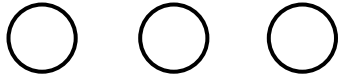
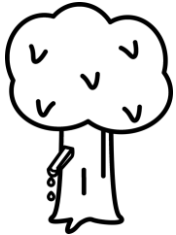
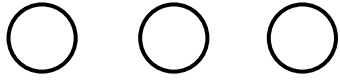
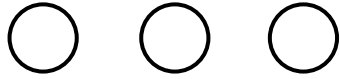

CVC Encoding Practice

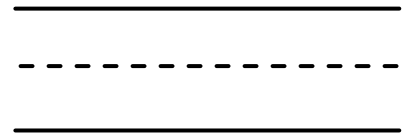
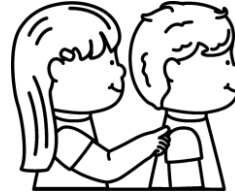
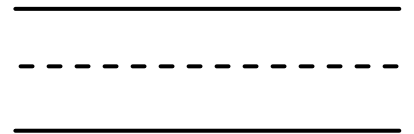
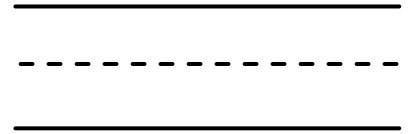
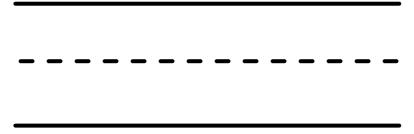
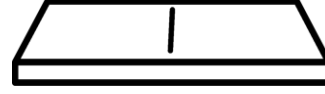

Fold here.

Name: _____

Directions: Say, tap, map, and graph the words.

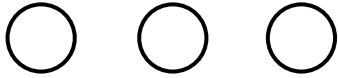

--	--	--

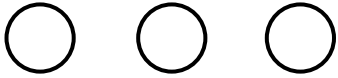
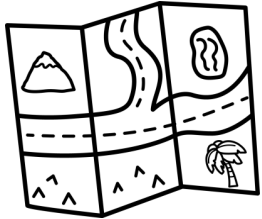

--	--	--

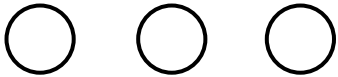

--	--	--

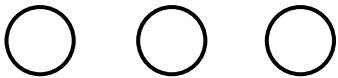
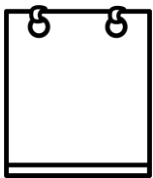

--	--	--

CVC Encoding Practice



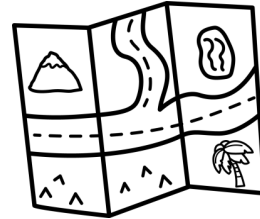



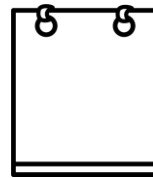

Fold here.

Name: _____

Directions: Say, tap, map, and graph the words.

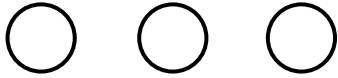

--	--	--

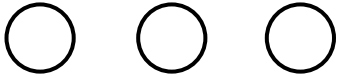
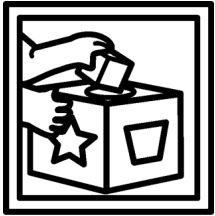

--	--	--

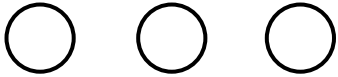

--	--	--

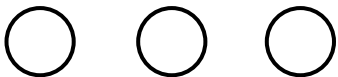

--	--	--

CVC Encoding Practice



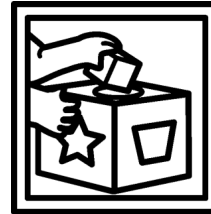





Fold here.

Name: _____

Directions: Say, tap, map, and graph the words.

CVC Encoding Practice

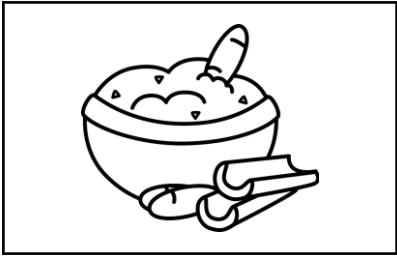

○ ○ ○

--	--	--

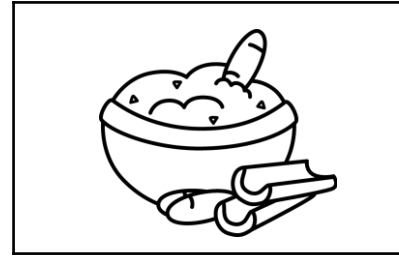

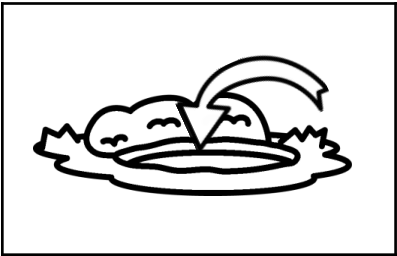

○ ○ ○

--	--	--

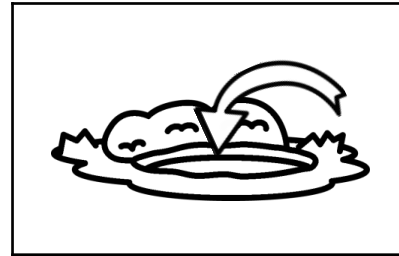

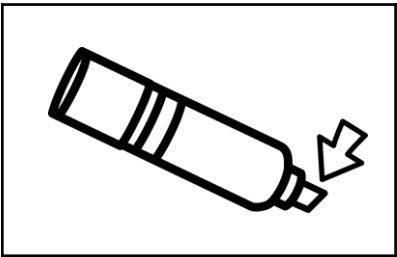

○ ○ ○

--	--	--

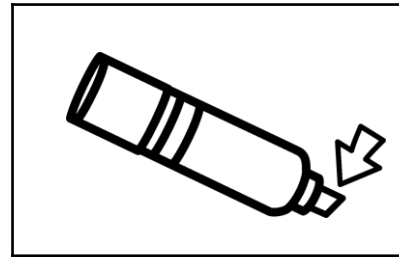

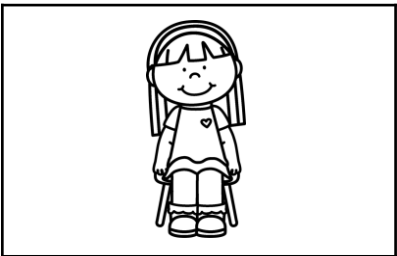

○ ○ ○

--	--	--

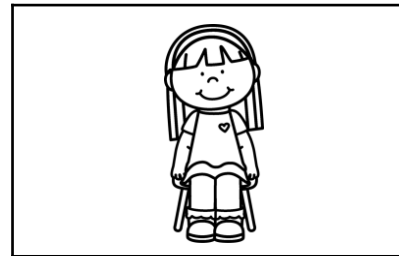

Fold here.

Name: _____

Directions: Say, tap, map, and graph the words.

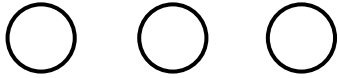
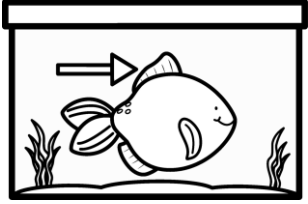

--	--	--

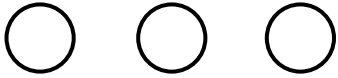

--	--	--

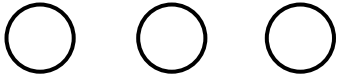
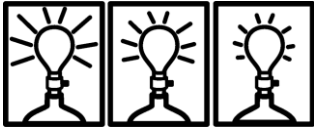

--	--	--

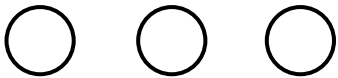
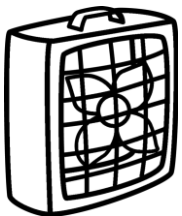

--	--	--

CVC Encoding Practice

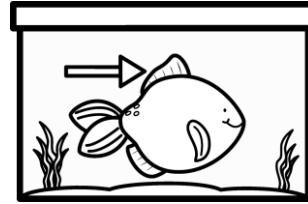



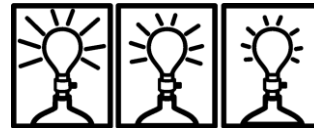

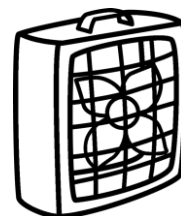

Fold here.

Name: _____

CVC Encoding Practice

Directions: Say, tap, map, and graph the words.

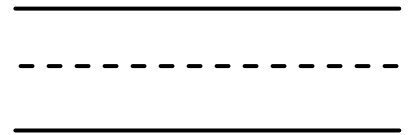
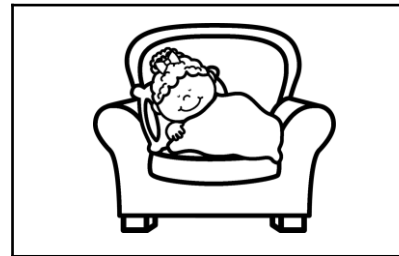
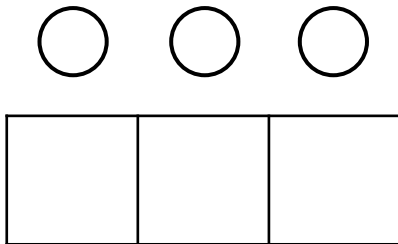
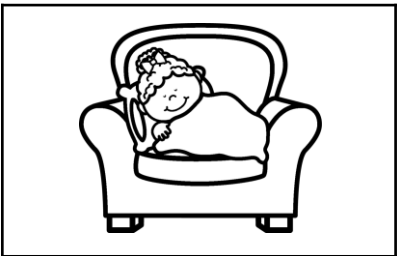
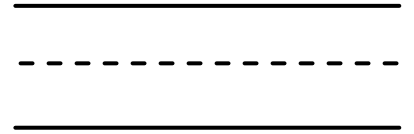
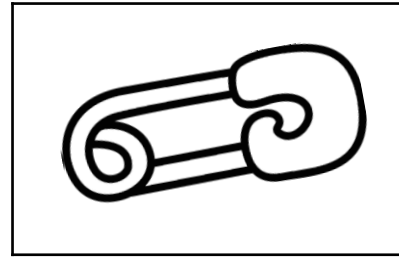
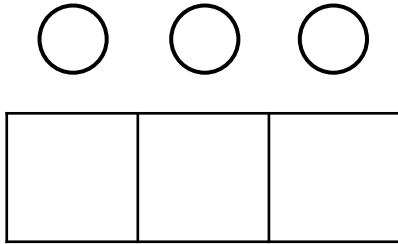
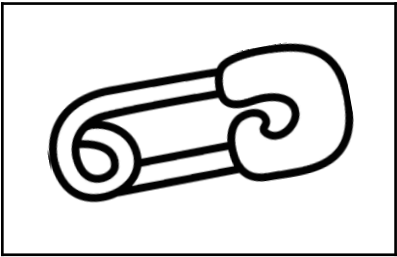
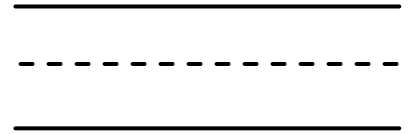
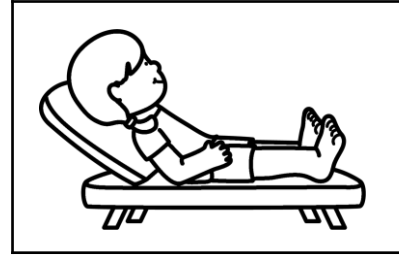
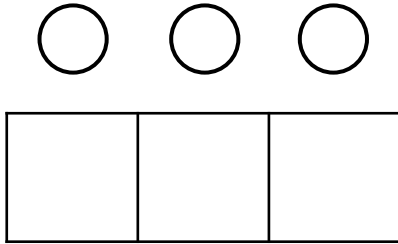
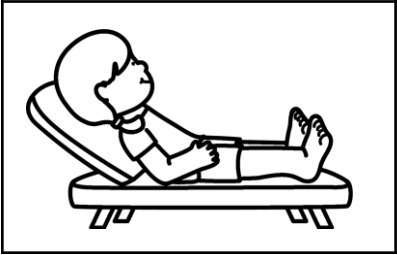
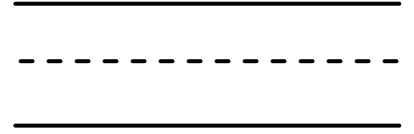
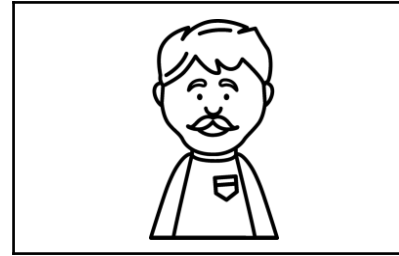
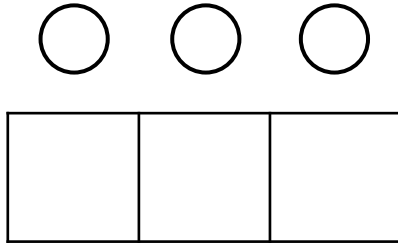
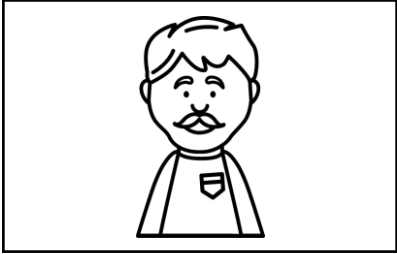

Fold here.

Name: _____

Directions: Say, tap, map, and graph the words.

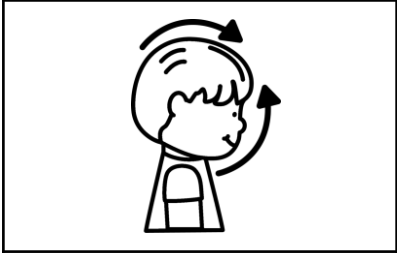

○ ○ ○

--	--	--

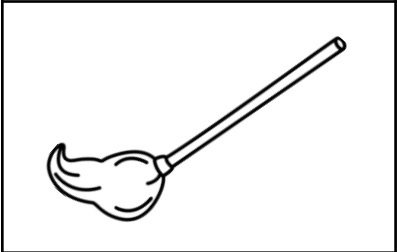

○ ○ ○

--	--	--

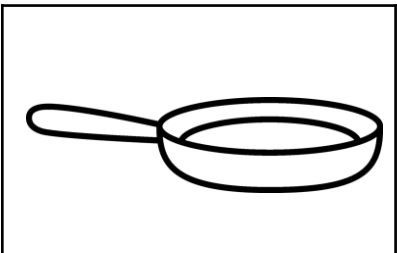

○ ○ ○

--	--	--

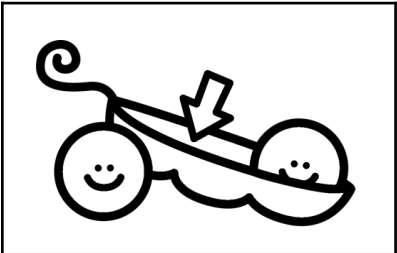

○ ○ ○

--	--	--

CVC Encoding Practice

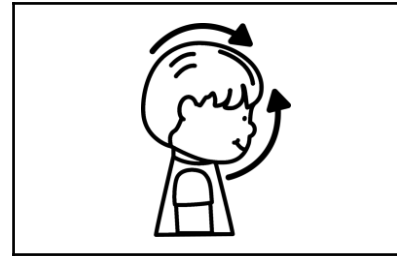

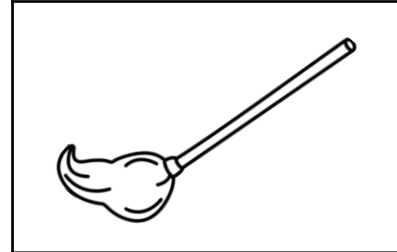

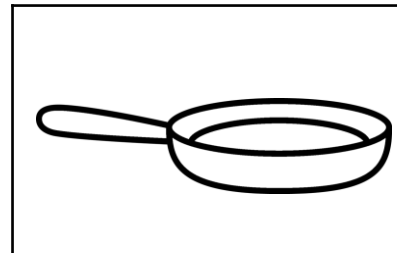

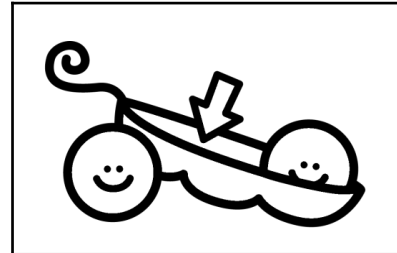

Fold here.

Name: _____

Directions: Say, tap, map, and graph the words.

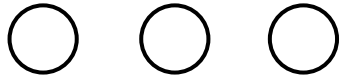
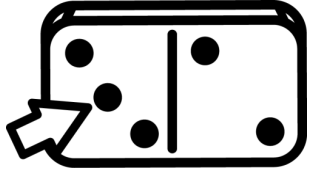

--	--	--

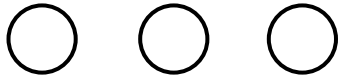

--	--	--

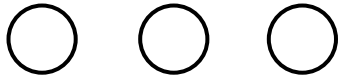

--	--	--

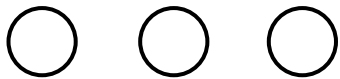
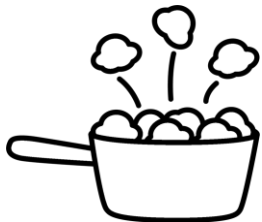

--	--	--

CVC Encoding Practice

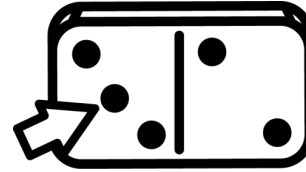





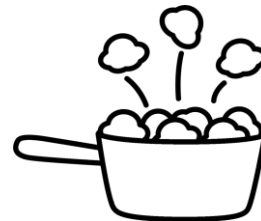

Fold here.

Name: _____

Directions: Say, tap, map, and graph the words.

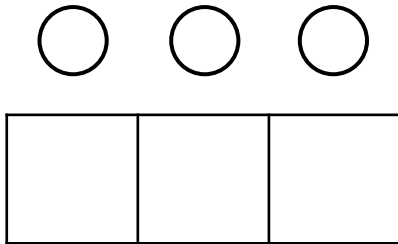
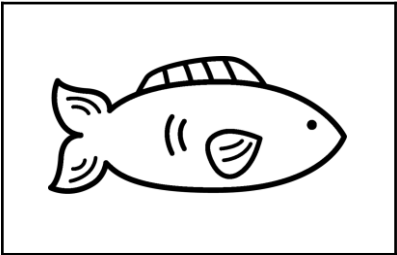
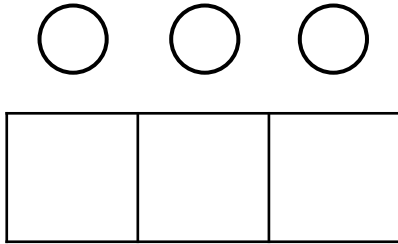
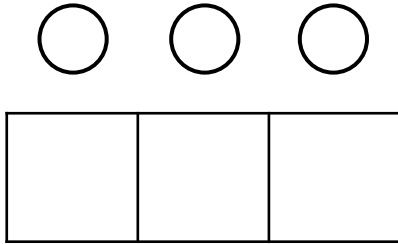
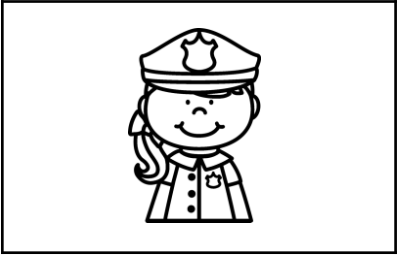
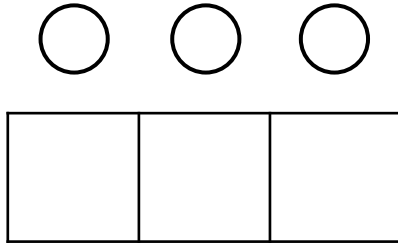
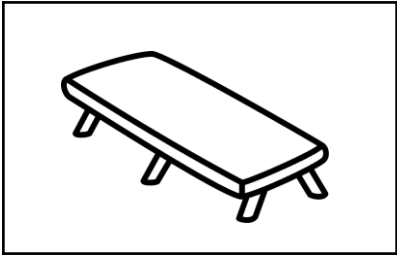

CVC Encoding Practice

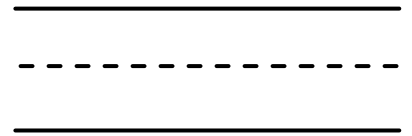
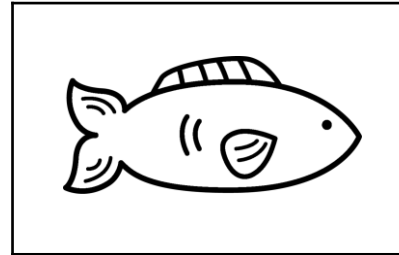
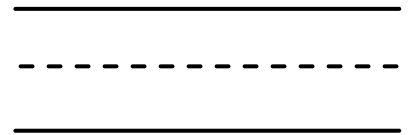
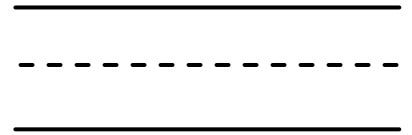
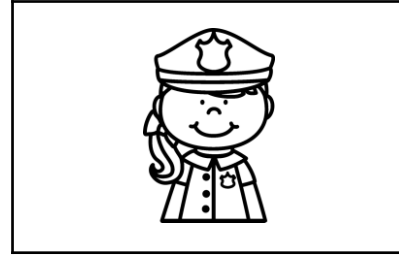
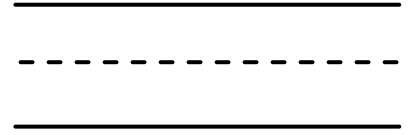
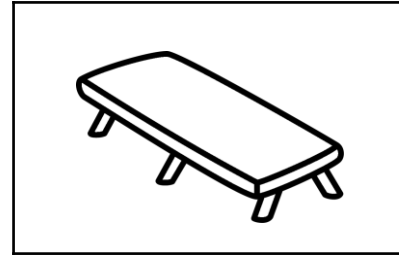

Fold here.

Name: _____

Directions: Say, tap, map, and graph the words.

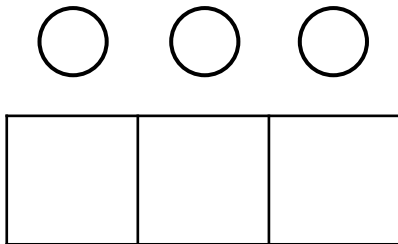
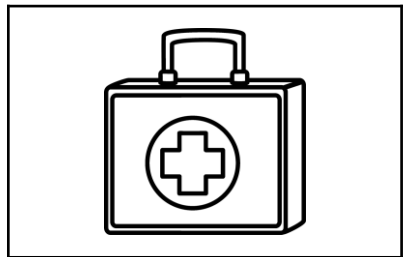
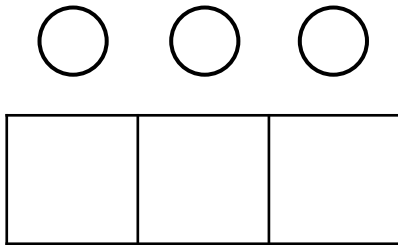
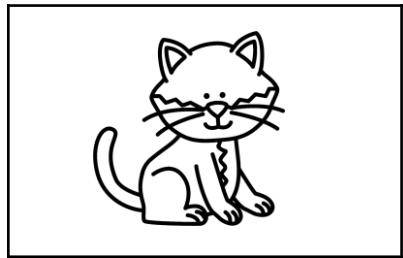
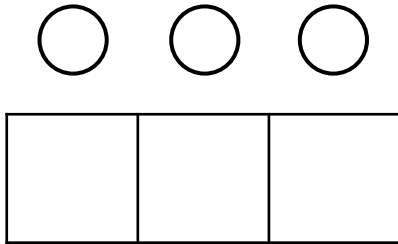
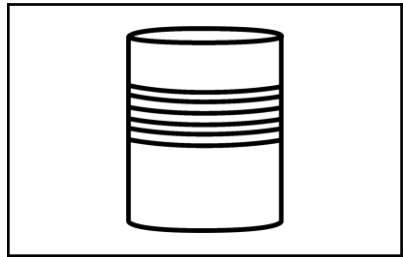
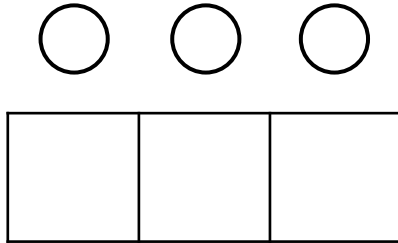
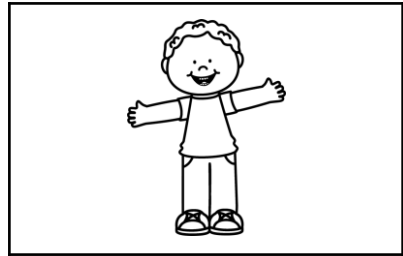

CVC Encoding Practice

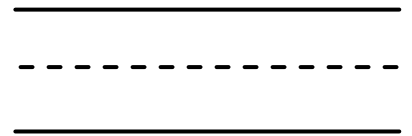
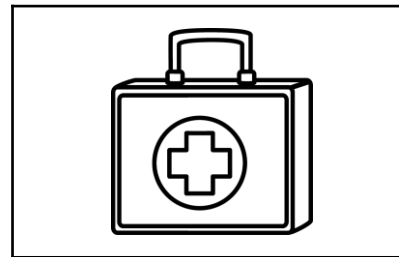
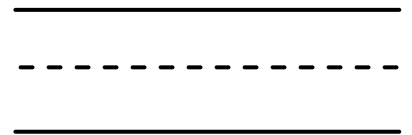
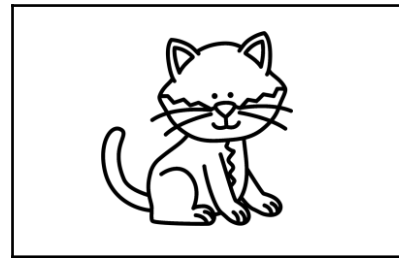
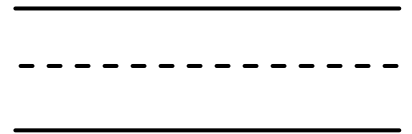
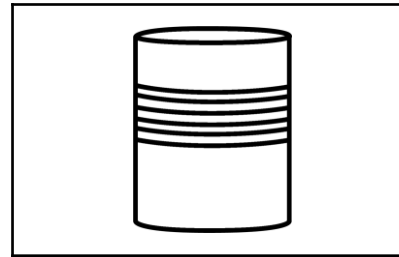
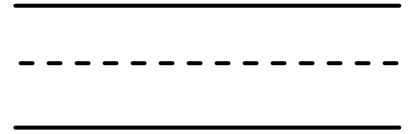
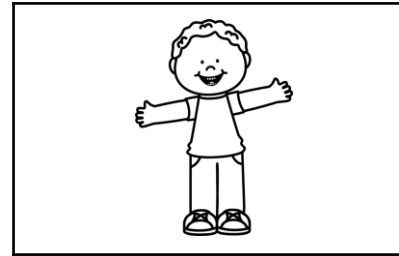

Fold here.

Name: _____

Directions: Say, tap, map, and graph the words.

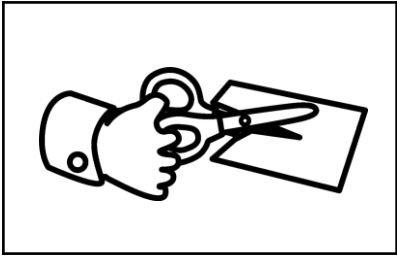

○ ○ ○

--	--	--

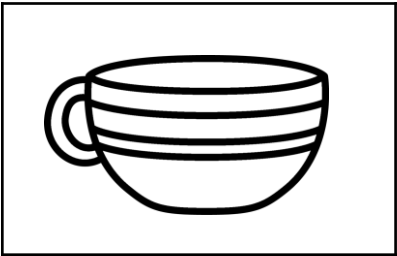

○ ○ ○

--	--	--

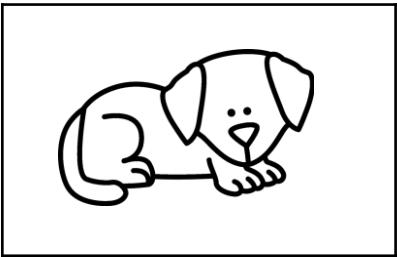

○ ○ ○

--	--	--



○ ○ ○

--	--	--

CVC Encoding Practice

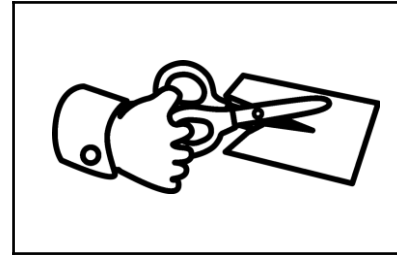

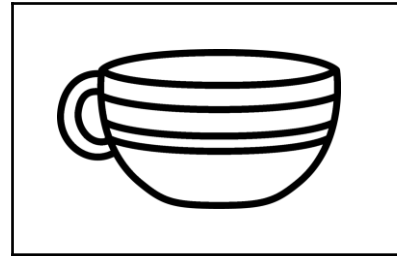

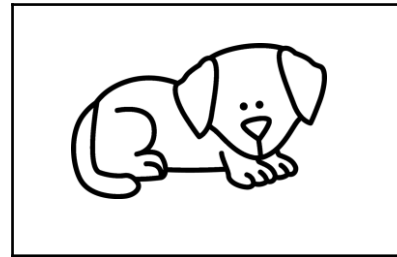



Fold here.

Name: _____

Directions: Say, tap, map, and graph the words.

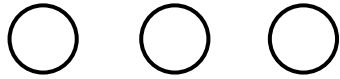
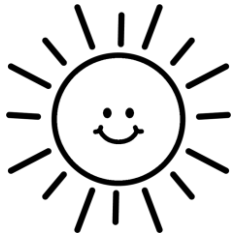

--	--	--

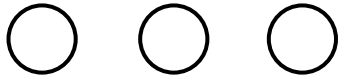
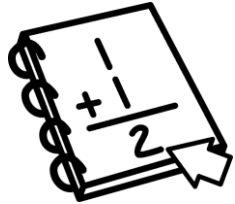

--	--	--

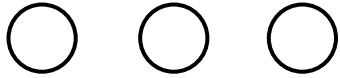
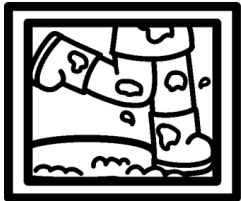

--	--	--

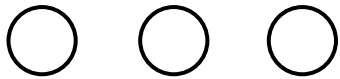
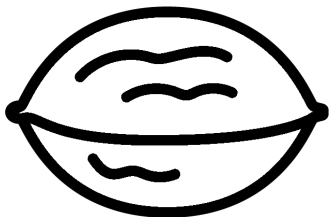

--	--	--

CVC Encoding Practice

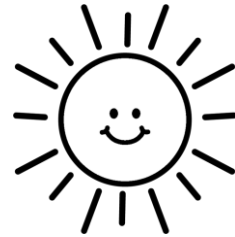

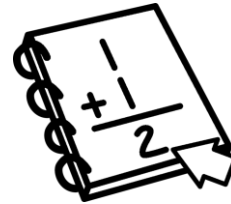

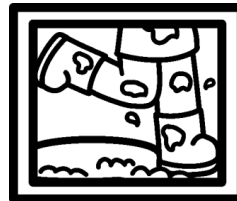

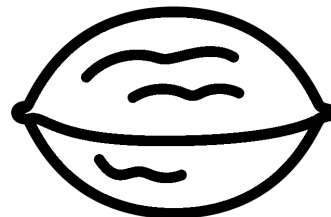

Fold here.

Name: _____

Directions: Say, tap, map, and graph the words.

CVC Encoding Practice

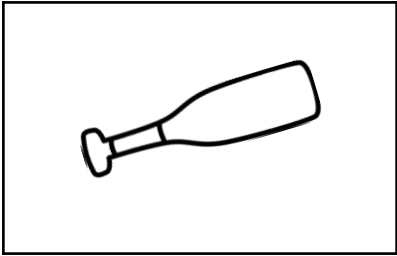

○ ○ ○

--	--	--

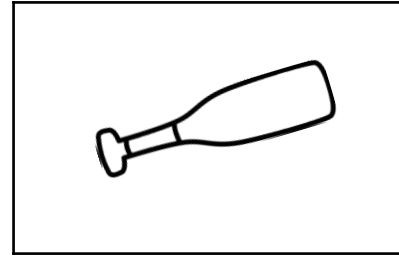

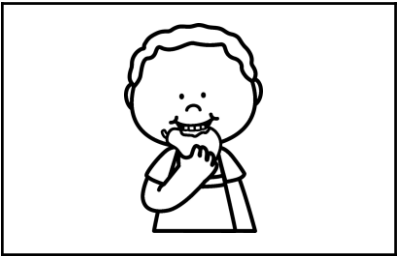

○ ○ ○

--	--	--

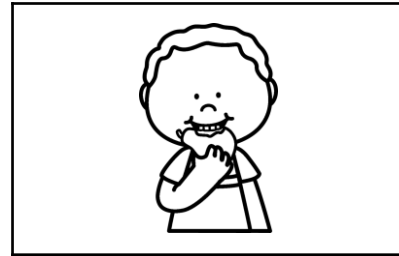

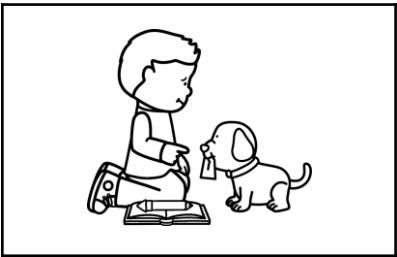

○ ○ ○

--	--	--

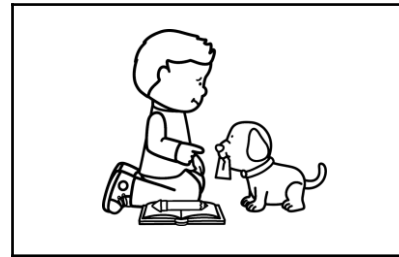

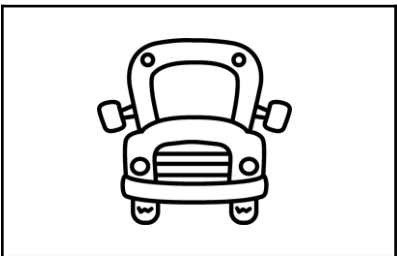

○ ○ ○

--	--	--

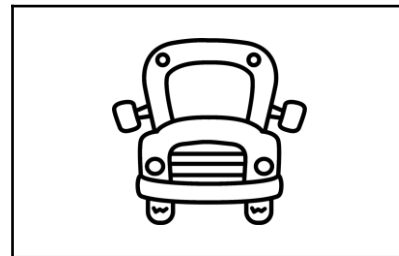

Fold here.

Name: _____

Directions: Say, tap, map, and graph the words.

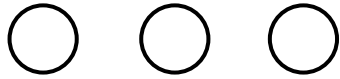
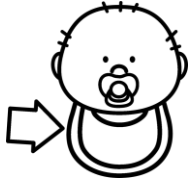

--	--	--

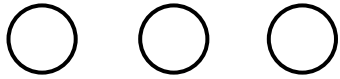

--	--	--

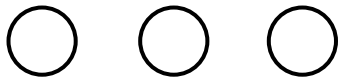
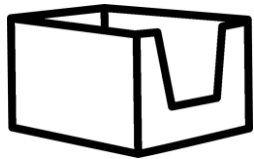

--	--	--

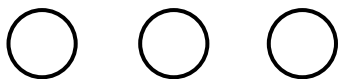
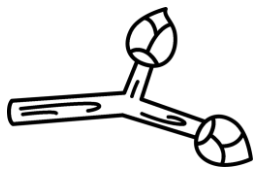

--	--	--

CVC Encoding Practice

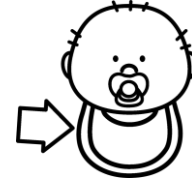



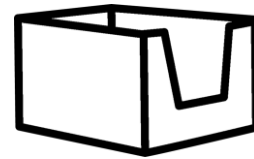

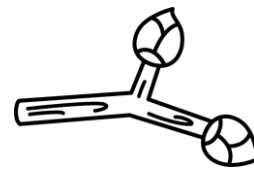

Fold here.

Name: _____

Directions: Say, tap, map, and graph the words.

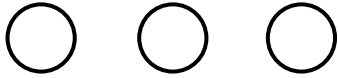
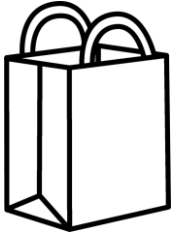

--	--	--

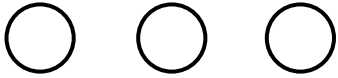

--	--	--

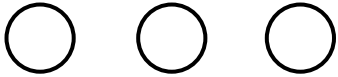

--	--	--

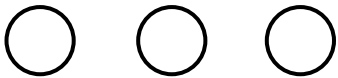

--	--	--

CVC Encoding Practice

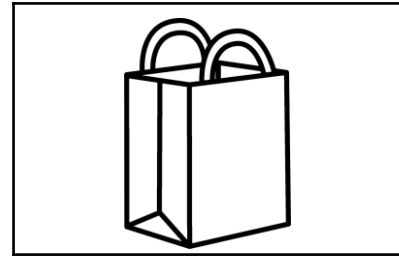

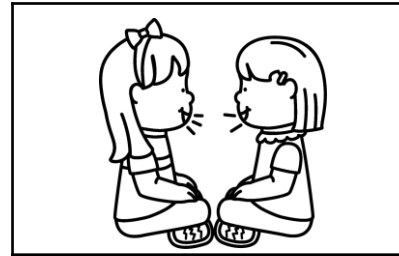

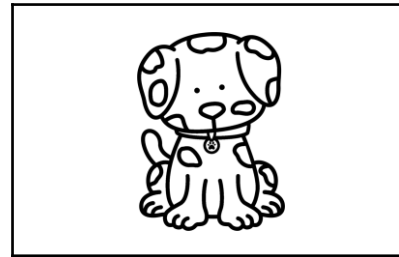



Fold here.

Name: _____

Directions: Say, tap, map, and graph the words.

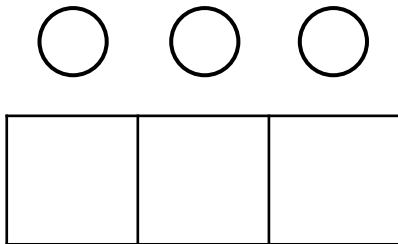
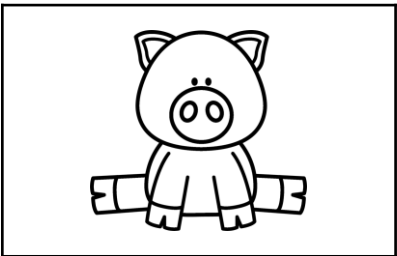
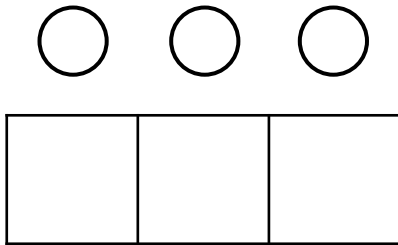
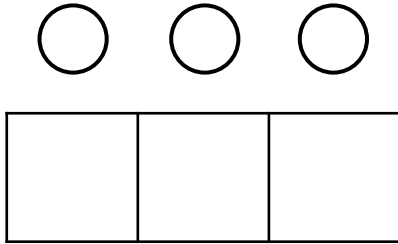
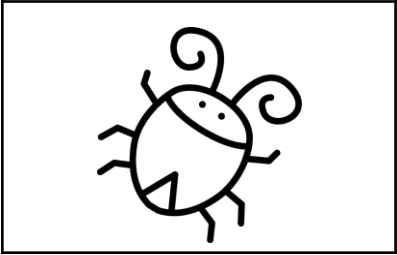
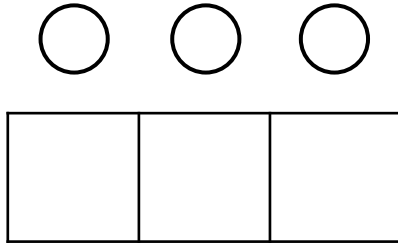
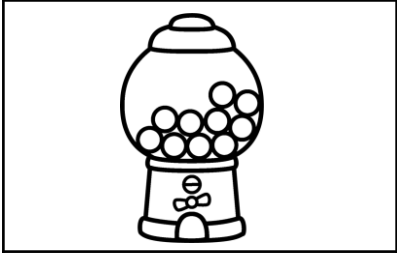

CVC Encoding Practice

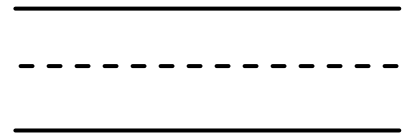
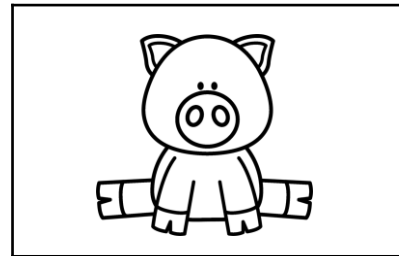
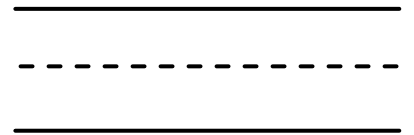
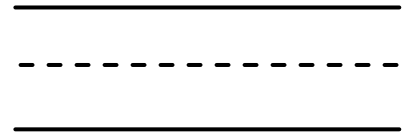
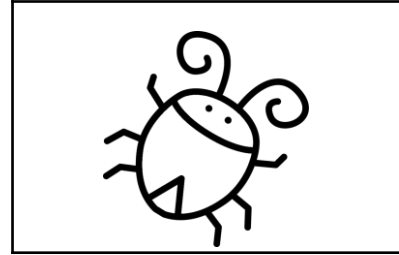
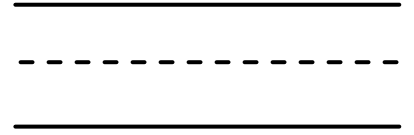
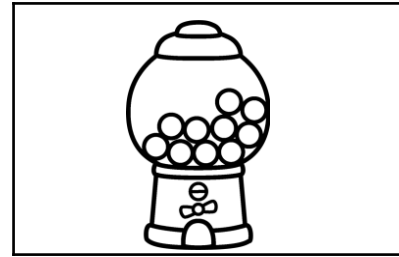

Fold here.

Name: _____

Directions: Say, tap, map, and graph the words.

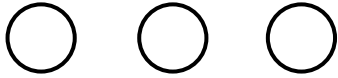

--	--	--

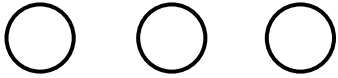
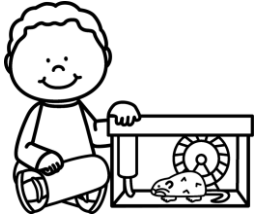

--	--	--

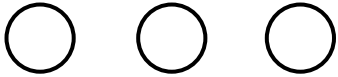
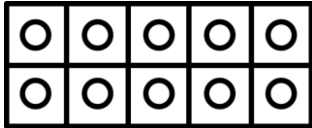

--	--	--

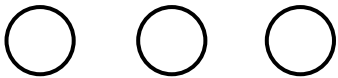
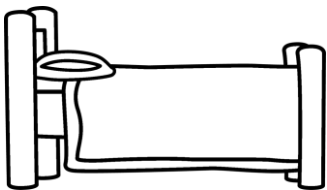

--	--	--

CVC Encoding Practice





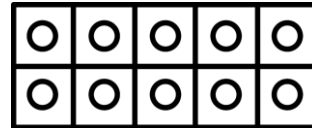

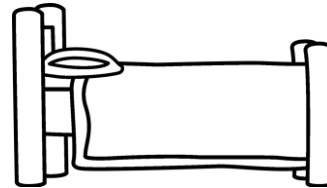

Fold here.

Name: _____

Directions: Say, tap, map, and graph the words.

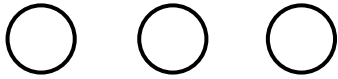

--	--	--

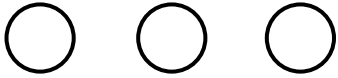
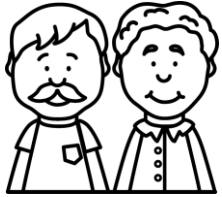

--	--	--

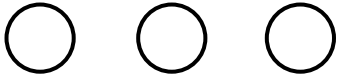
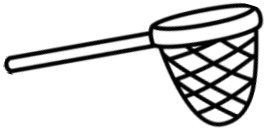

--	--	--

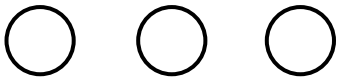

--	--	--

CVC Encoding Practice



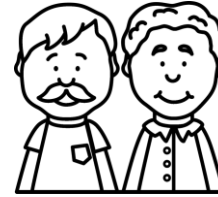

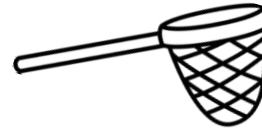



Fold here.

Name: _____

Directions: Say, tap, map, and graph the words.

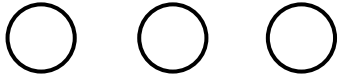
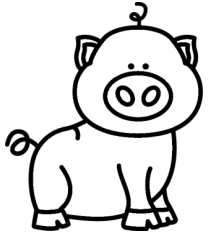

--	--	--

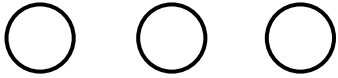

--	--	--

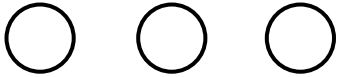
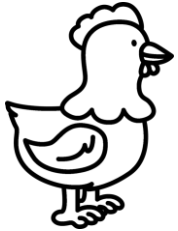

--	--	--

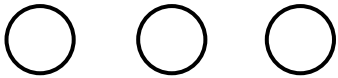
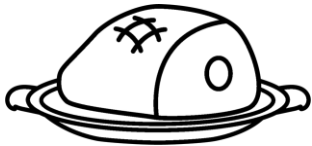

--	--	--

CVC Encoding Practice

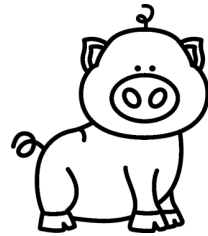



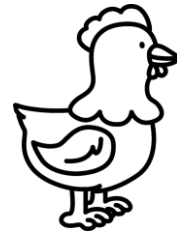

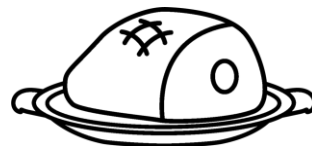

Fold here.

Name: _____

Directions: Say, tap, map, and graph the words.

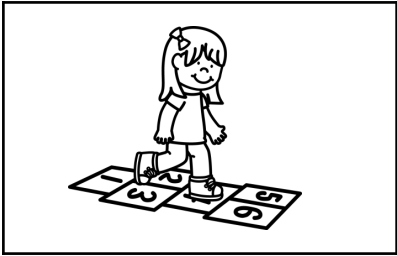

○ ○ ○

--	--	--

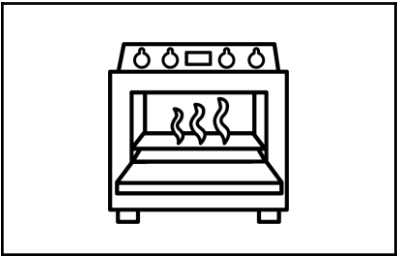

○ ○ ○

--	--	--

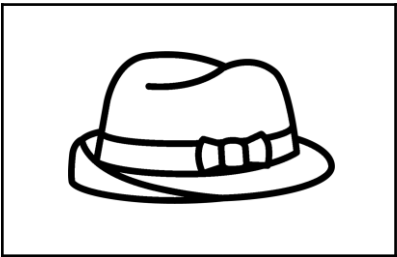

○ ○ ○

--	--	--

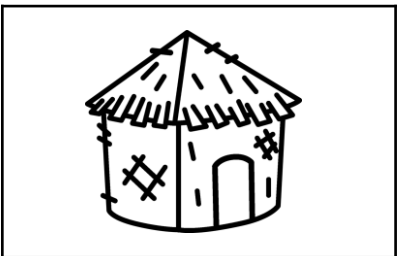

○ ○ ○

--	--	--

CVC Encoding Practice

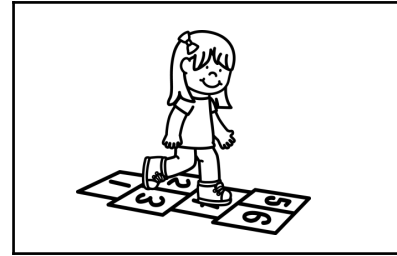

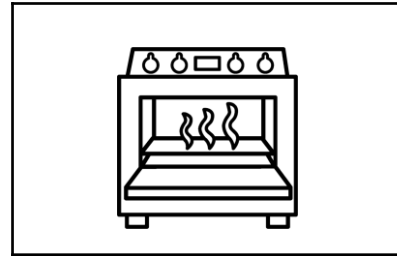

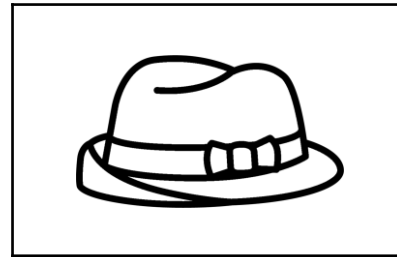

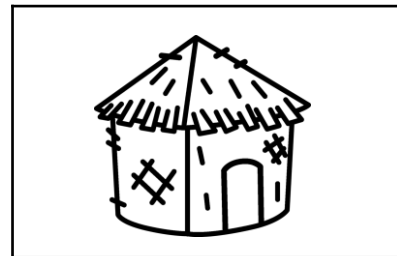

Fold here.

Name: _____

Directions: Say, tap, map, and graph the words.

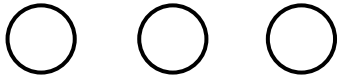
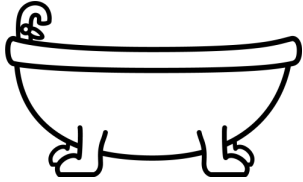

--	--	--

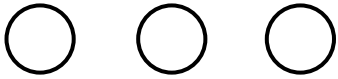
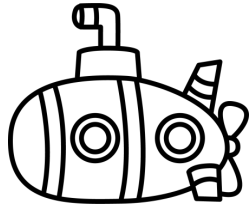

--	--	--

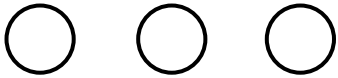

--	--	--

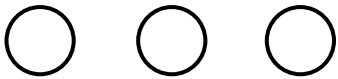

--	--	--

CVC Encoding Practice

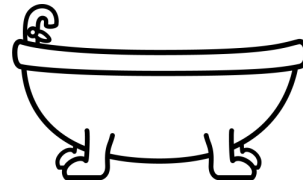

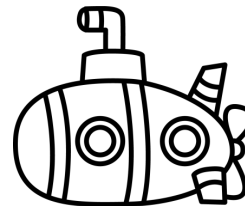





Fold here.

Name: _____

Directions: Say, tap, map, and graph the words.

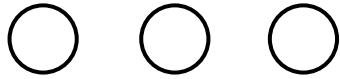

--	--	--

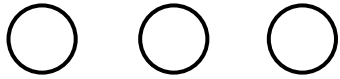
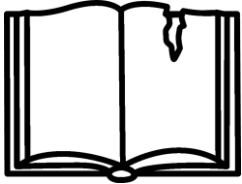

--	--	--

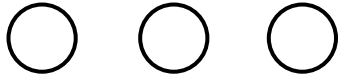

--	--	--

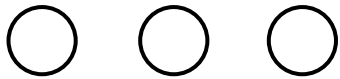
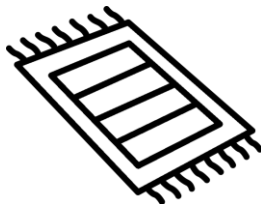

--	--	--

CVC Encoding Practice



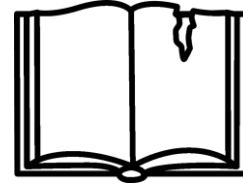



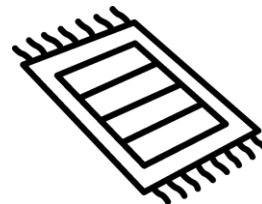

Fold here.

Name: _____

Directions: Say, tap, map, and graph the words.

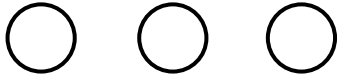

--	--	--

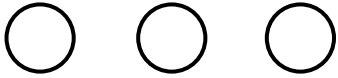

--	--	--

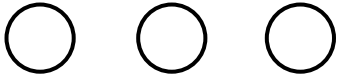

--	--	--

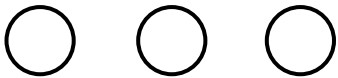

--	--	--

CVC Encoding Practice



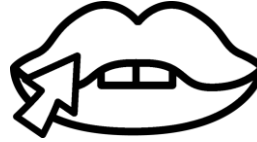





Fold here.

Name: _____

Directions: Say, tap, map, and graph the words.

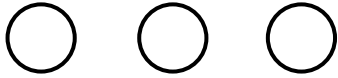

--	--	--

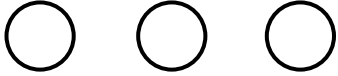
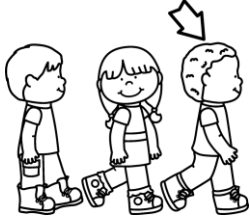

--	--	--

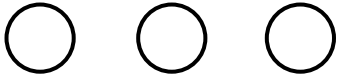

--	--	--

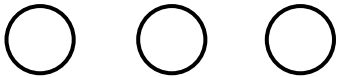

--	--	--

CVC Encoding Practice



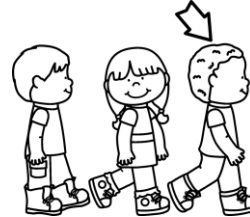





Fold here.

Name: _____

Directions: Say, tap, map, and graph the words.

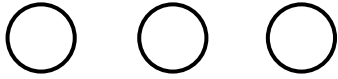
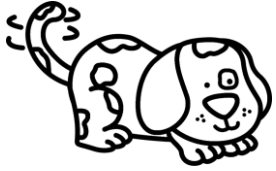

--	--	--

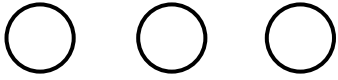

--	--	--

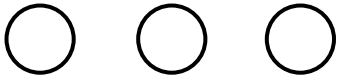

--	--	--

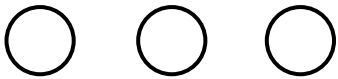

--	--	--

CVC Encoding Practice









Fold here.

Name: _____

Directions: Say, tap, map, and graph the words.

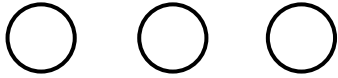

--	--	--

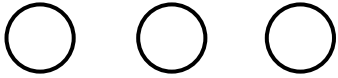
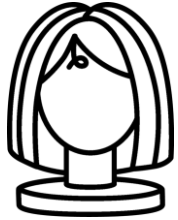

--	--	--

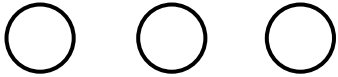

--	--	--

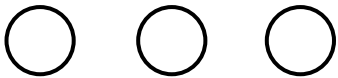
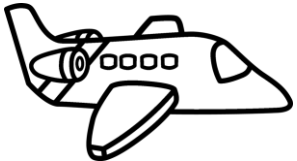

--	--	--

CVC Encoding Practice







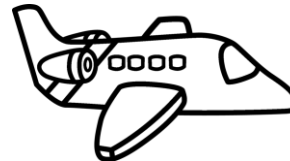

Fold here.

Name: _____

Directions: Say, tap, map, and graph the words.

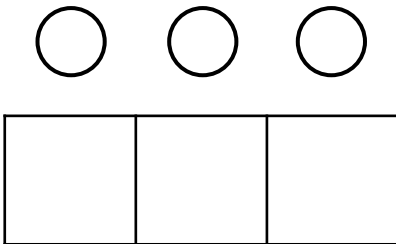
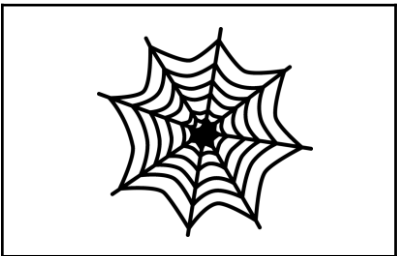
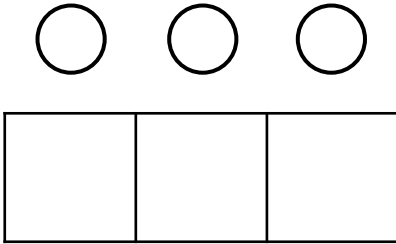
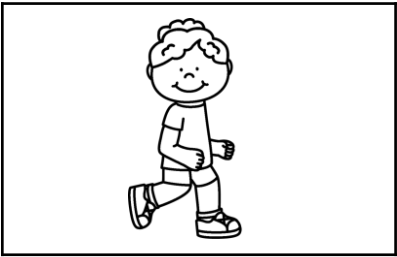
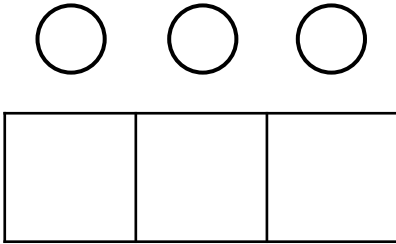
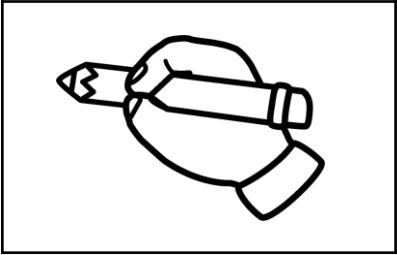
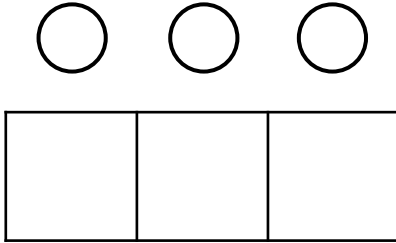

CVC Encoding Practice

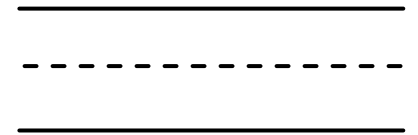
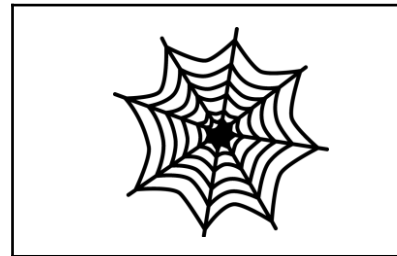
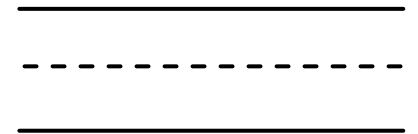
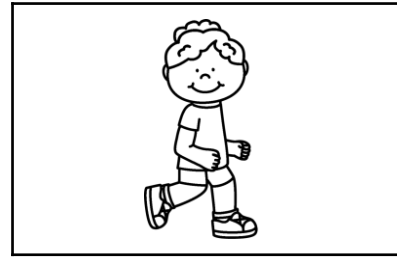
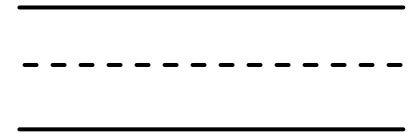
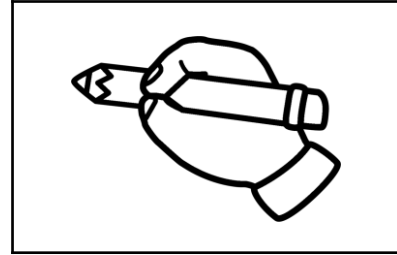
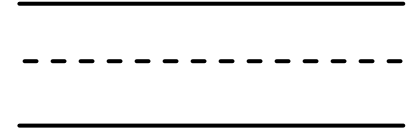
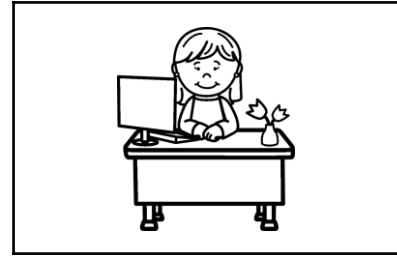

Fold here.

Name: _____

Directions: Say, tap, map, and graph the words.

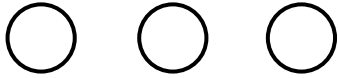

--	--	--

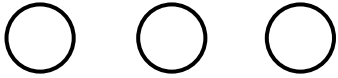

--	--	--

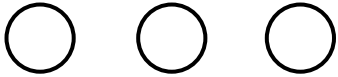

--	--	--

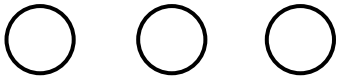

--	--	--

CVC Encoding Practice







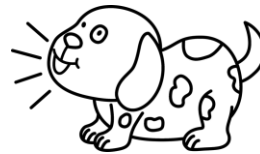

Fold here.

Name: _____

Directions: Say, tap, map, and graph the words.

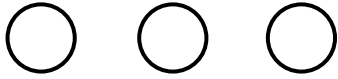

--	--	--

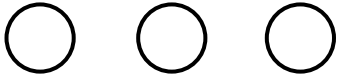

--	--	--

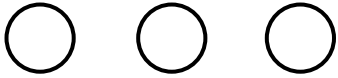

--	--	--

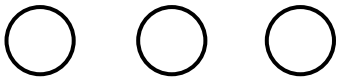
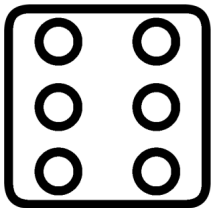

--	--	--

CVC Encoding Practice







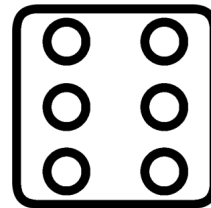

Fold here.

Name: _____

Directions: Say, tap, map, and graph the words.

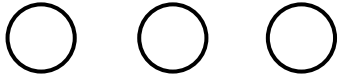
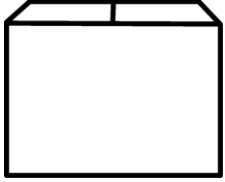

--	--	--

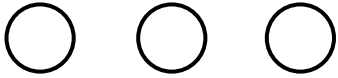

--	--	--

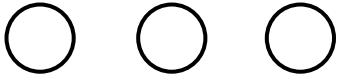

--	--	--

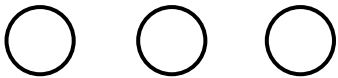

--	--	--

CVC Encoding Practice

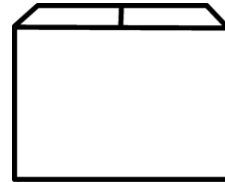







Fold here.

Name: _____

Directions: Say, tap, map, and graph the words.

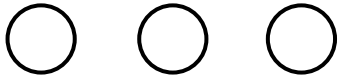

--	--	--

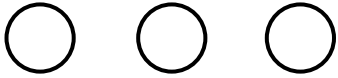

--	--	--

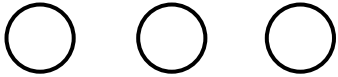

--	--	--

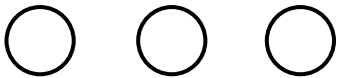
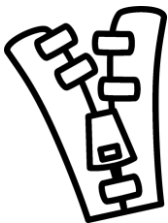

--	--	--

CVC Encoding Practice









Fold here.

Name: _____

Directions: Say, tap, map, and graph the words.

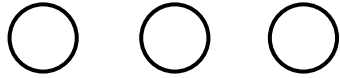

--	--	--

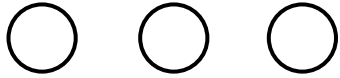

--	--	--

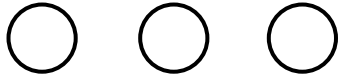

--	--	--

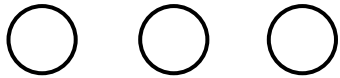
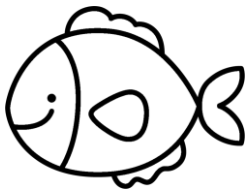

--	--	--

Digraphs Encoding Practice







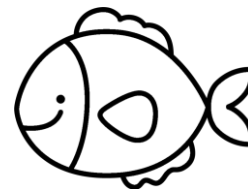

Fold here.

Name: _____

Directions: Say, tap, map, and graph the words.

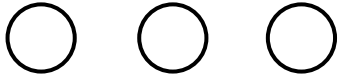

--	--	--

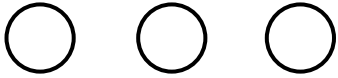

--	--	--

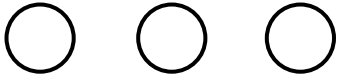

--	--	--

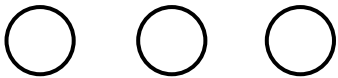

--	--	--

Digraphs Encoding Practice









Fold here.

Name: _____

Directions: Say, tap, map, and graph the words.

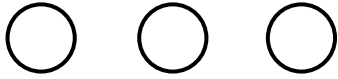

--	--	--

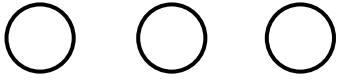
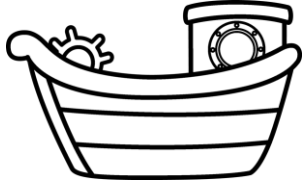

--	--	--

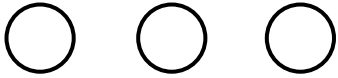

--	--	--

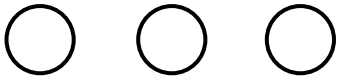

--	--	--

Digraphs Encoding Practice



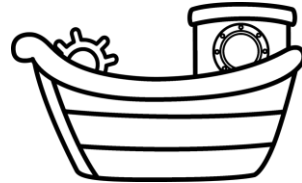





Fold here.

Name: _____

Directions: Say, tap, map, and graph the words.

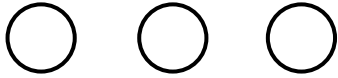
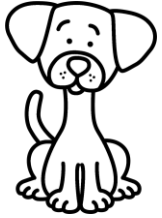

--	--	--

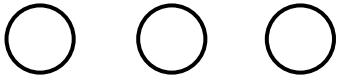

--	--	--

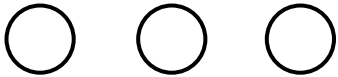
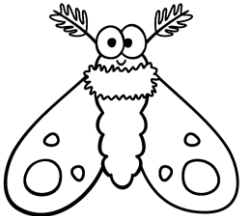

--	--	--

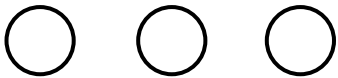

--	--	--

Digraphs Encoding Practice





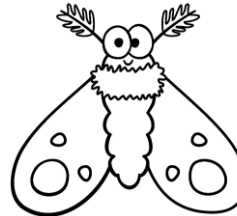

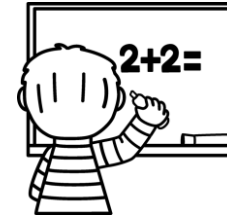

Fold here.

Name: _____

Directions: Say, tap, map, and graph the words.

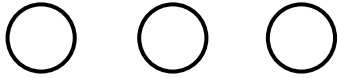

--	--	--

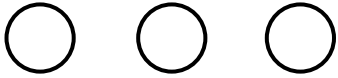

--	--	--

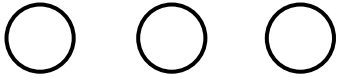

--	--	--

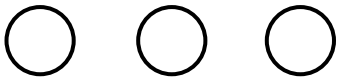
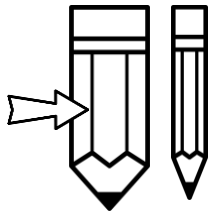

--	--	--

Digraphs Encoding Practice



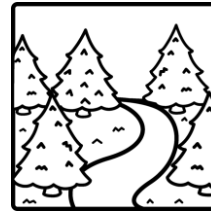

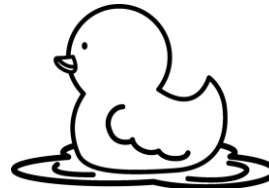

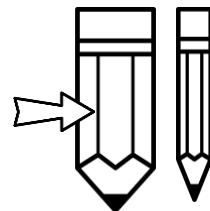

Fold here.

Name: _____

Directions: Say, tap, map, and graph the words.



○ ○ ○

--	--	--

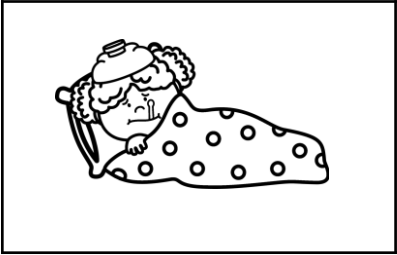

○ ○ ○

--	--	--

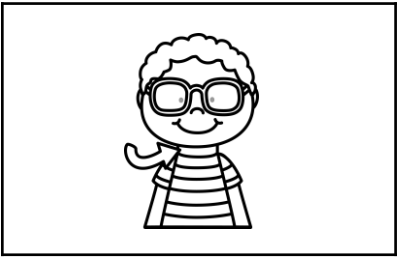

○ ○ ○

--	--	--

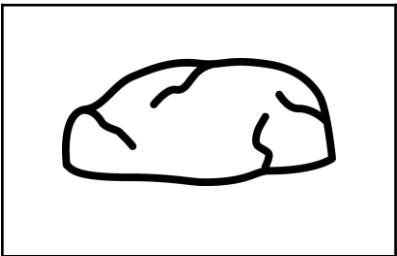

○ ○ ○

--	--	--

Digraphs Encoding Practice



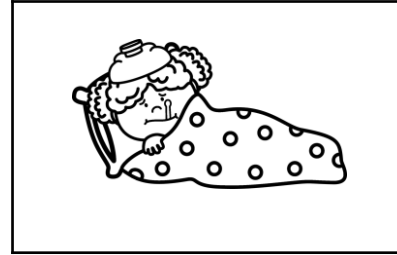

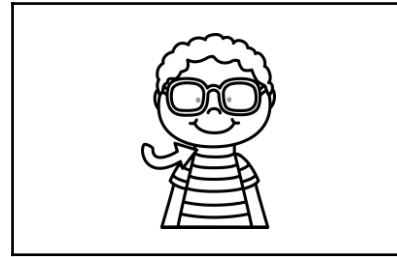

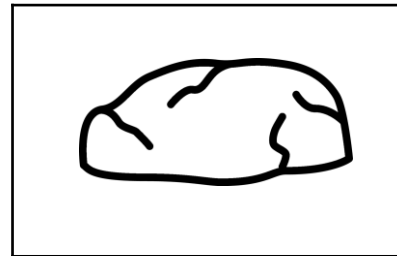

Fold here.

Name: _____

Directions: Say, tap, map, and graph the words.

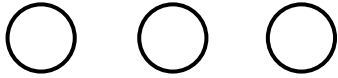

--	--	--

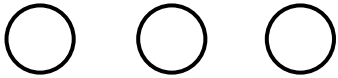

--	--	--

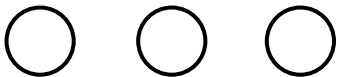

--	--	--

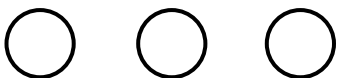

--	--	--

Digraphs Encoding Practice









Fold here.

Name: _____

Directions: Say, tap, map, and graph the words.

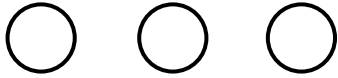

--	--	--

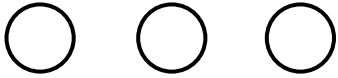
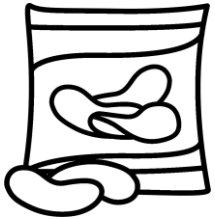

--	--	--

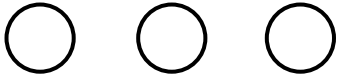
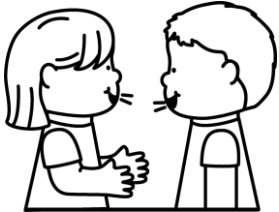

--	--	--

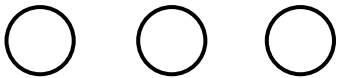

--	--	--

Digraphs Encoding Practice



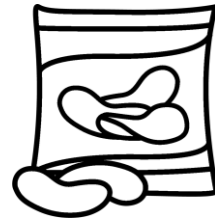



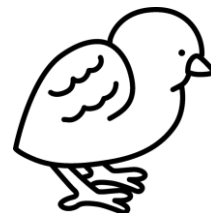

Fold here.

Name: _____

Directions: Say, tap, map, and graph the words.

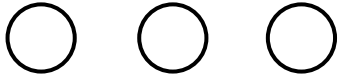

--	--	--

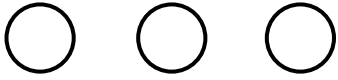

--	--	--

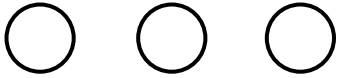

--	--	--

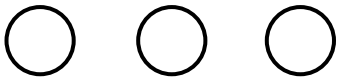

--	--	--

Digraphs Encoding Practice









Fold here.

Name: _____

Directions: Say, tap, map, and graph the words.

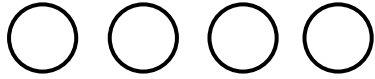
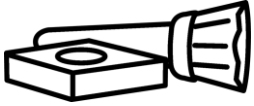

--	--	--	--

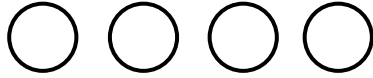
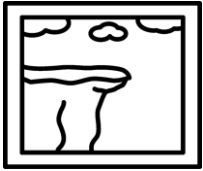

--	--	--	--

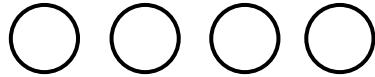

--	--	--	--

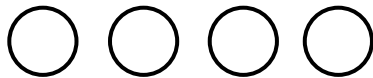

--	--	--	--

Blends Encoding Practice

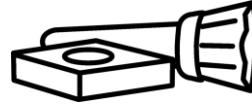

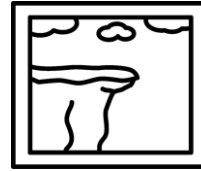



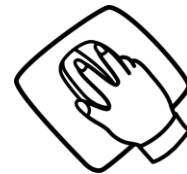

Fold here.

Name: _____

Directions: Say, tap, map, and graph the words.

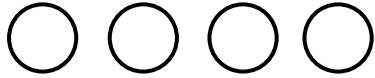

--	--	--	--

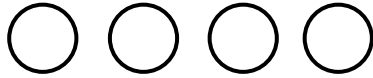

--	--	--	--

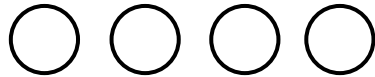

--	--	--	--

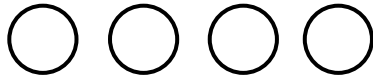
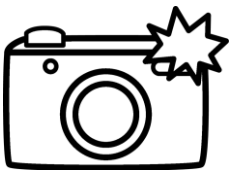

--	--	--	--

Blends Encoding Practice





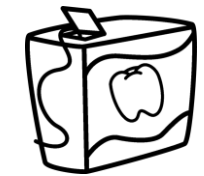

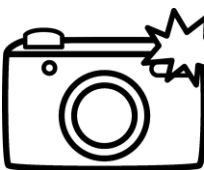

Fold here.

Name: _____

Directions: Say, tap, map, and graph the words.



--	--	--	--

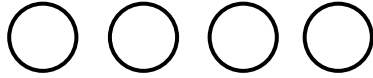
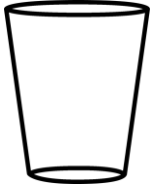

--	--	--	--



--	--	--	--

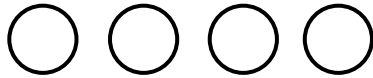
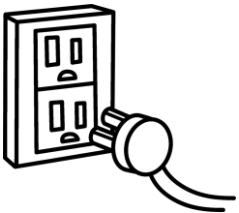

--	--	--	--

Blends Encoding Practice







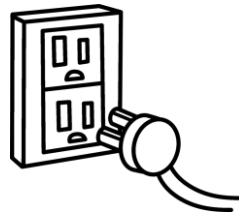

Fold here.

Name: _____

Directions: Say, tap, map, and graph the words.

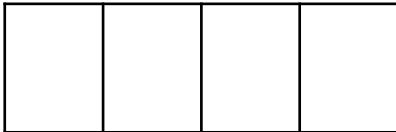
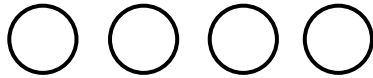
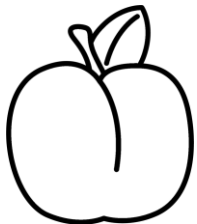
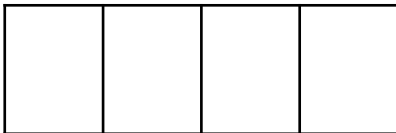
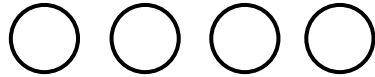
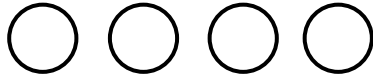
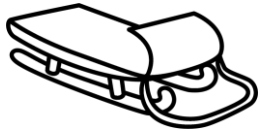
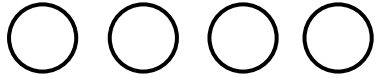
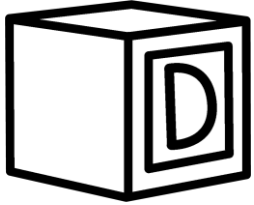

Blends Encoding Practice

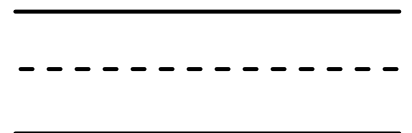
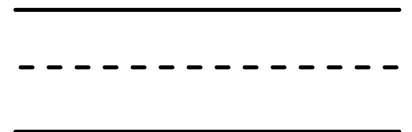
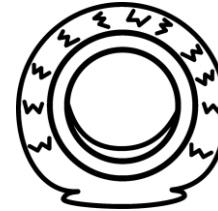
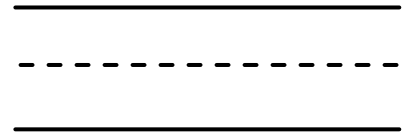
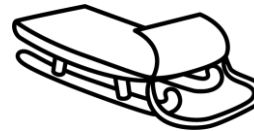
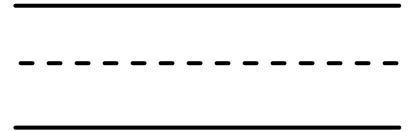
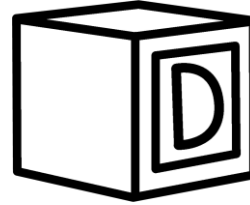

Fold here.

Name: _____

Directions: Say, tap, map, and graph the words.

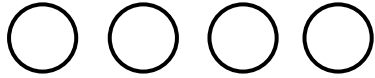
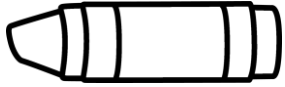

--	--	--	--

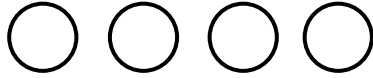

--	--	--	--

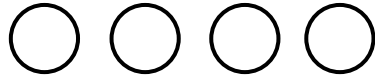
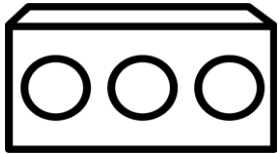

--	--	--	--

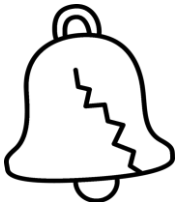

--	--	--	--

Blends Encoding Practice

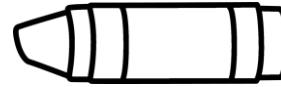



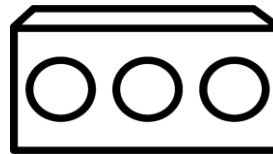



Fold here.

Name: _____

Directions: Say, tap, map, and graph the words.

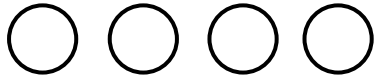
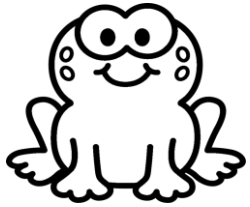

--	--	--	--

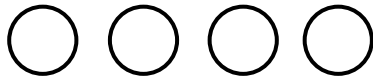
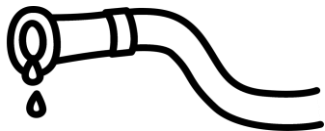

--	--	--	--

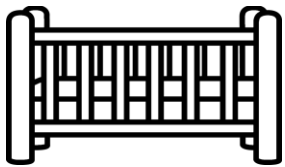

--	--	--	--

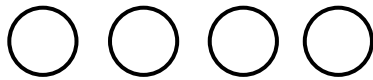

--	--	--	--

Blends Encoding Practice

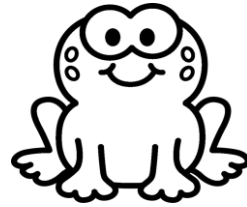

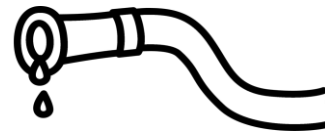

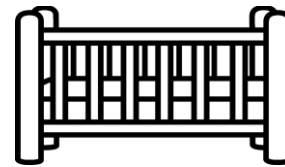

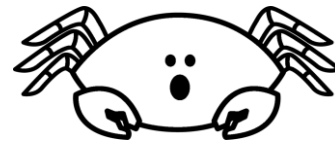

Fold here.

Name: _____

Directions: Say, tap, map, and graph the words.



--	--	--	--

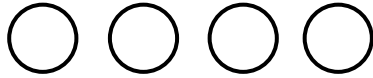

--	--	--	--

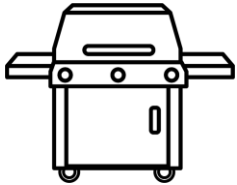

--	--	--	--

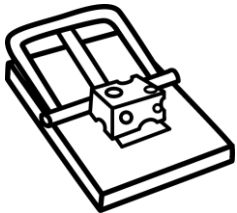

--	--	--	--

Blends Encoding Practice





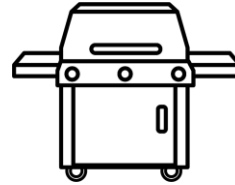

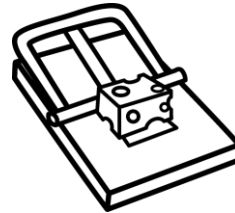

Fold here.

Name: _____

Directions: Say, tap, map, and graph the words.

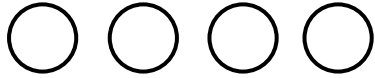

--	--	--	--

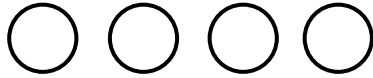

--	--	--	--

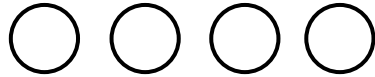

--	--	--	--

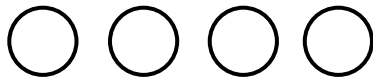

--	--	--	--

Blends Encoding Practice









Fold here.

Name: _____

Directions: Say, tap, map, and graph the words.

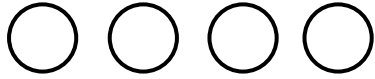
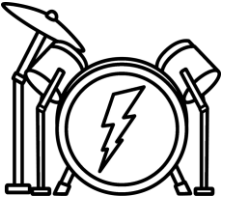

--	--	--	--



--	--	--	--



--	--	--	--

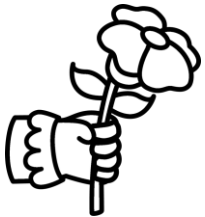

--	--	--	--

Blends Encoding Practice

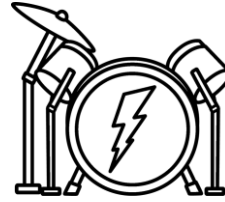





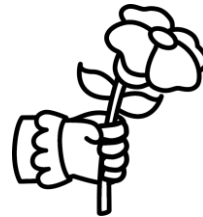

Fold here.

Name: _____

Directions: Say, tap, map, and graph the words.

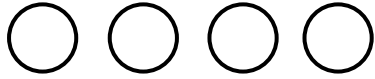

--	--	--	--



--	--	--	--

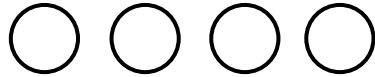
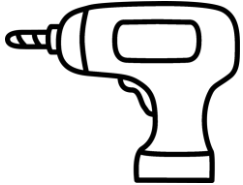

--	--	--	--

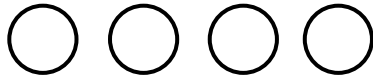

--	--	--	--

Blends Encoding Practice





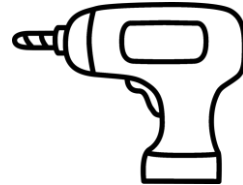



Fold here.

Name: _____

Directions: Say, tap, map, and graph the words.



--	--	--	--



--	--	--	--

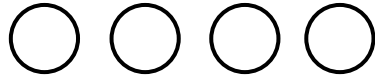
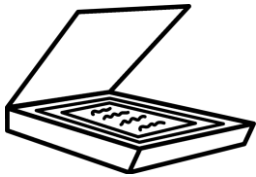

--	--	--	--

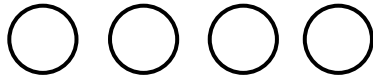

--	--	--	--

Blends Encoding Practice









Fold here.

Name: _____

Directions: Say, tap, map, and graph the words.

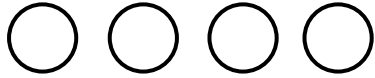

--	--	--	--

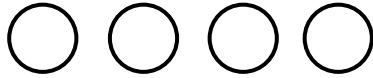

--	--	--	--

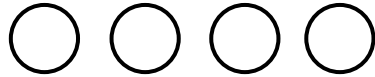
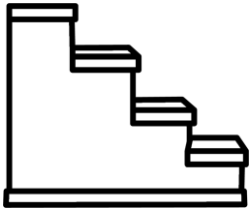

--	--	--	--

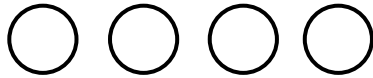

--	--	--	--

Blends Encoding Practice



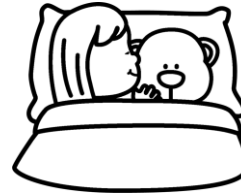

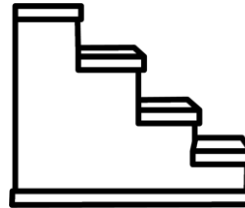



Fold here.

Name: _____

Directions: Say, tap, map, and graph the words.



--	--	--	--

Blends Encoding Practice





--	--	--	--



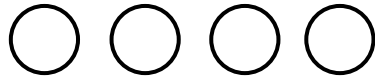

--	--	--	--





--	--	--	--



Fold here.

Name: _____

CVCe Encoding Practice

Directions: Say, tap, map, and graph the words.



○ ○ ○ (e)
[] [] [] (e)



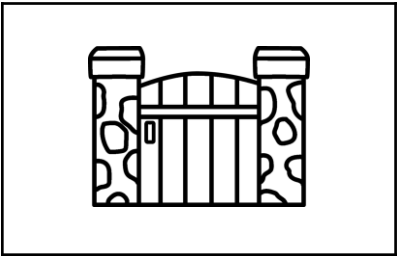

○ ○ ○ (e)
[] [] [] (e)

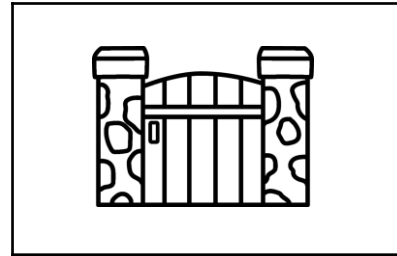

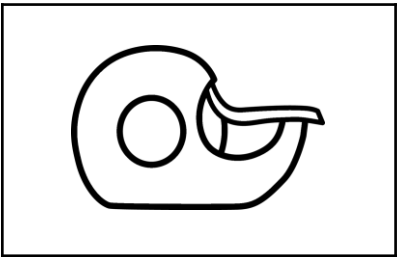

○ ○ ○ (e)
[] [] [] (e)

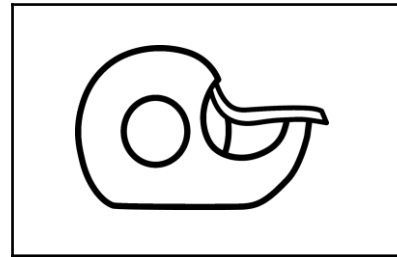

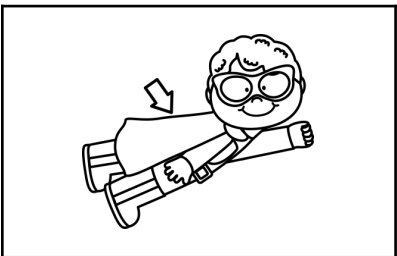

○ ○ ○ (e)
[] [] [] (e)

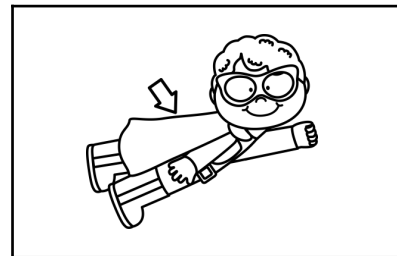

Fold here.

Name: _____

CVCe Encoding Practice

Directions: Say, tap, map, and graph the words.



--	--	--

e



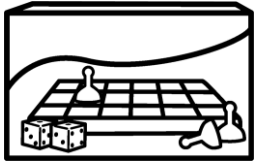

--	--	--

e

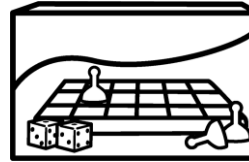



--	--	--

e





--	--	--

e



Fold here.

Name: _____

CVCe Encoding Practice

Directions: Say, tap, map, and graph the words.



--	--	--

pen





--	--	--

pen



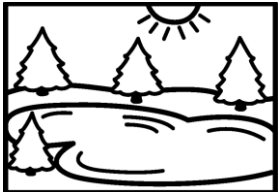

--	--	--

pen





--	--	--

pen



Fold here.

Name: _____

CVCe Encoding Practice

Directions: Say, tap, map, and graph the words.



○ ○ ○ (e)
[] [] [] (e)



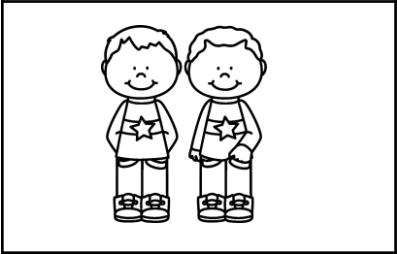

○ ○ ○ (e)
[] [] [] (e)

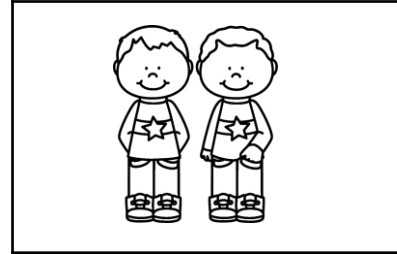

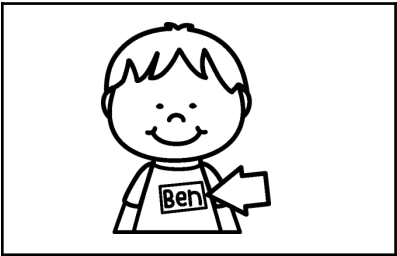

○ ○ ○ (e)
[] [] [] (e)

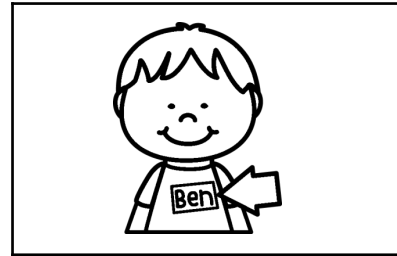

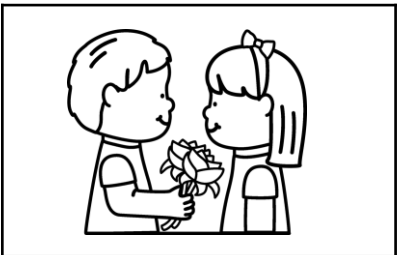

○ ○ ○ (e)
[] [] [] (e)

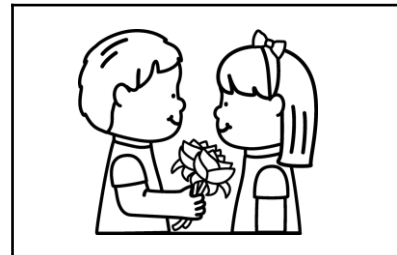

Fold here.

Name: _____

CVCe Encoding Practice

Directions: Say, tap, map, and graph the words.

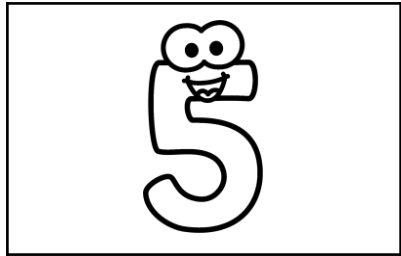

○ ○ ○ (e)
[] [] [] (e)

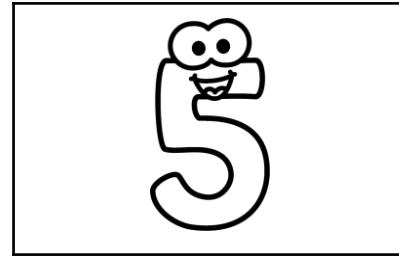

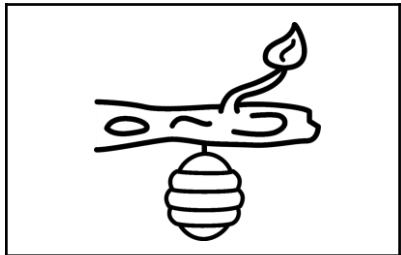

○ ○ ○ (e)
[] [] [] (e)

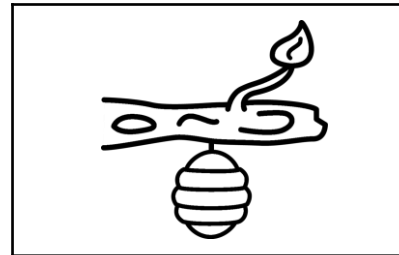



○ ○ ○ (e)
[] [] [] (e)

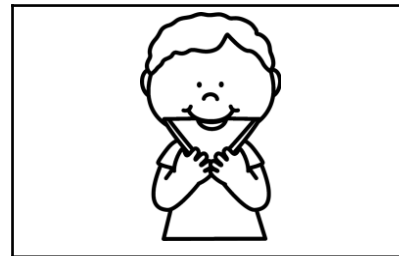

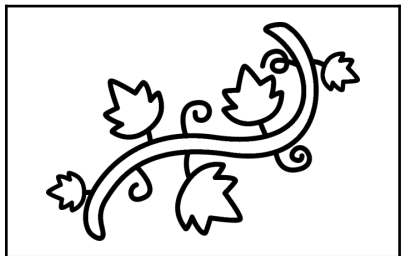

○ ○ ○ (e)
[] [] [] (e)

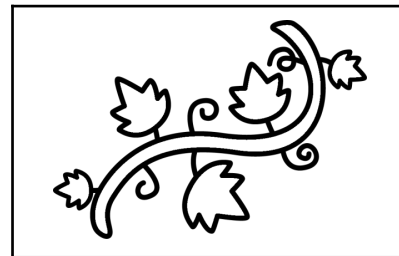

Fold here.

Name: _____

CVCe Encoding Practice

Directions: Say, tap, map, and graph the words.

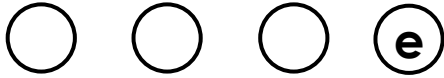
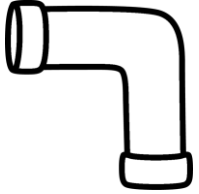

--	--	--

e

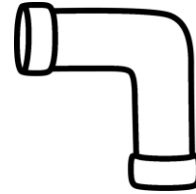

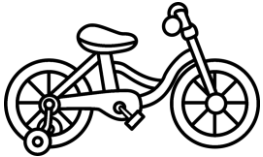

--	--	--

e

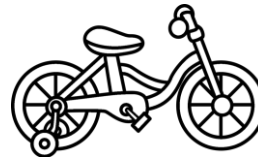

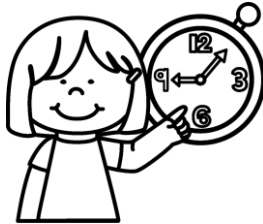

--	--	--

e

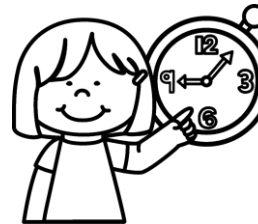



--	--	--

e



Fold here.

Name: _____

CVCe Encoding Practice

Directions: Say, tap, map, and graph the words.



--	--	--

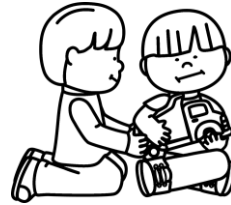

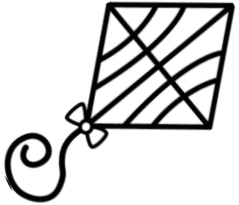

--	--	--

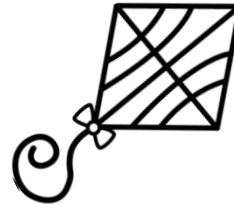



--	--	--





--	--	--



Fold here.

Name: _____

CVCe Encoding Practice

Directions: Say, tap, map, and graph the words.



--	--	--





--	--	--

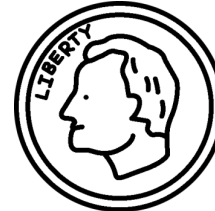



--	--	--



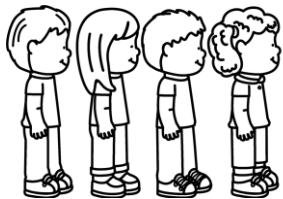

--	--	--

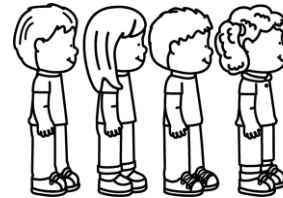

Fold here.

Name: _____

CVCe Encoding Practice

Directions: Say, tap, map, and graph the words.

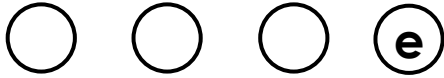
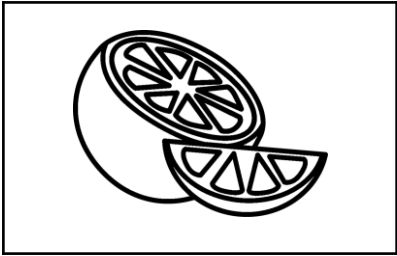

--	--	--

e

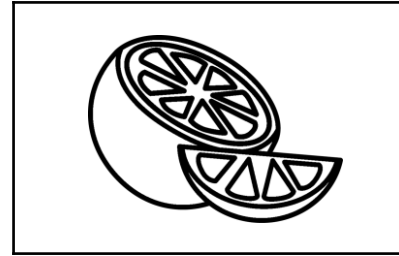

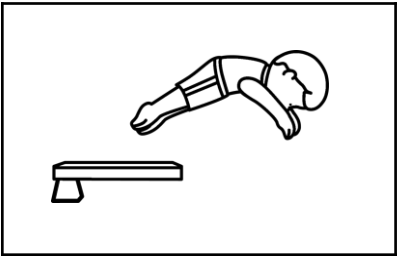

--	--	--

e

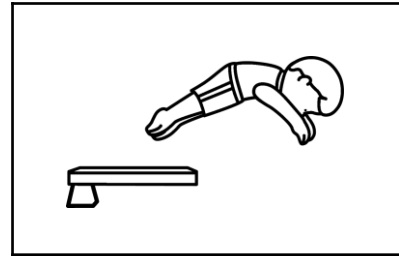

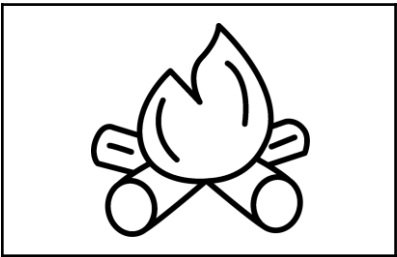

--	--	--

e

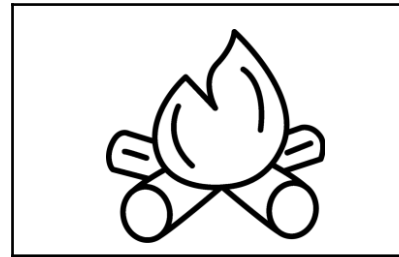

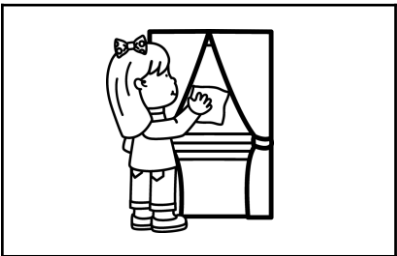

--	--	--

e

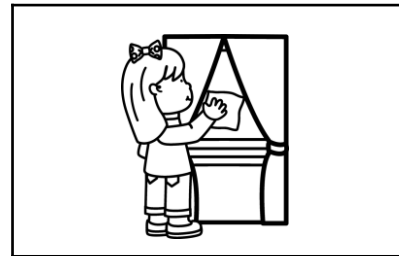

Fold here.

Name: _____

CVCe Encoding Practice

Directions: Say, tap, map, and graph the words.

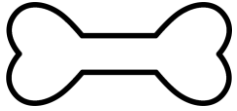

--	--	--

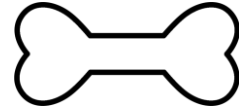

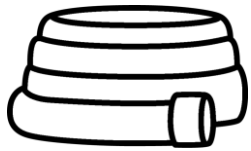

--	--	--

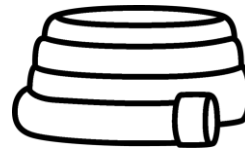



--	--	--





--	--	--



Fold here.

Name: _____

CVCe Encoding Practice

Directions: Say, tap, map, and graph the words.



--	--	--

e

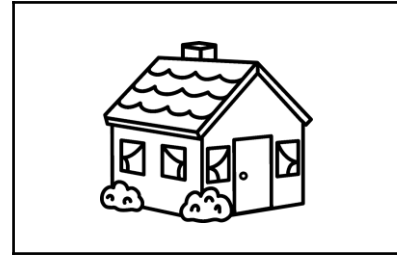

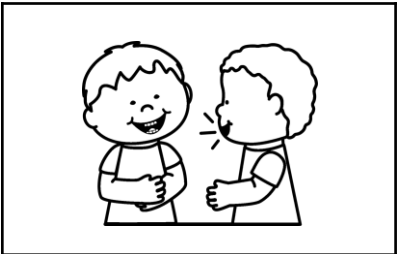

--	--	--

e

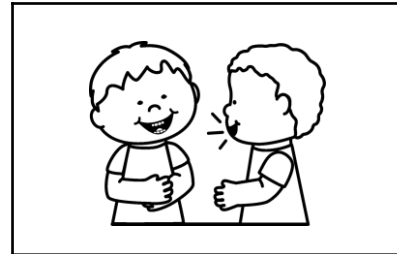

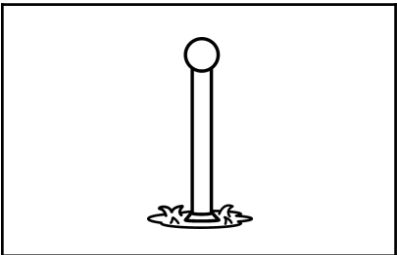

--	--	--

e

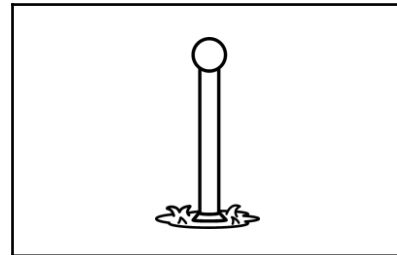

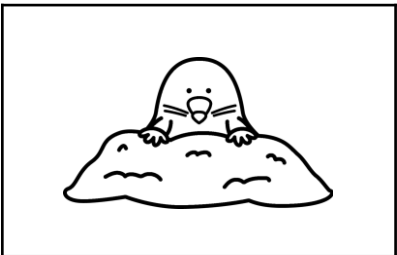

--	--	--

e



Fold here.

Name: _____

CVCe Encoding Practice

Directions: Say, tap, map, and graph the words.

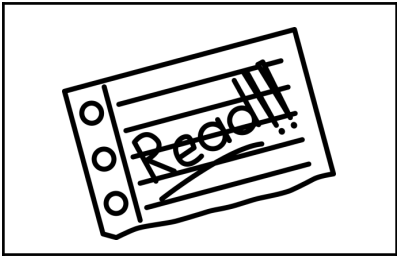

○ ○ ○ (e)
□ □ □ (e)

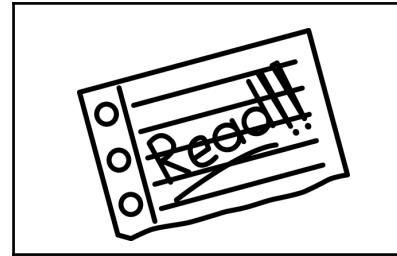

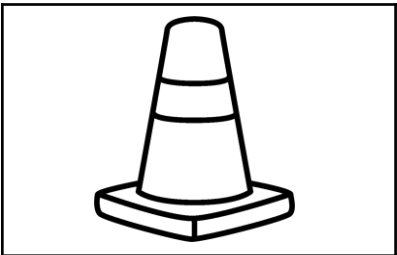

○ ○ ○ (e)
□ □ □ (e)

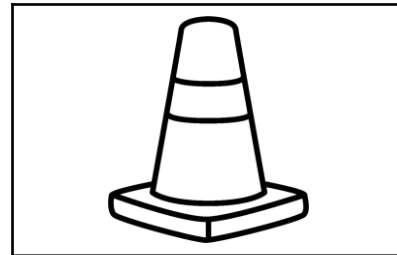

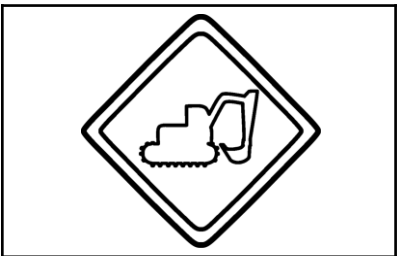

○ ○ ○ (e)
□ □ □ (e)

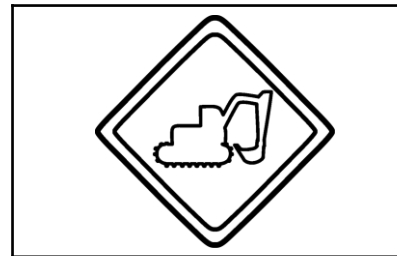

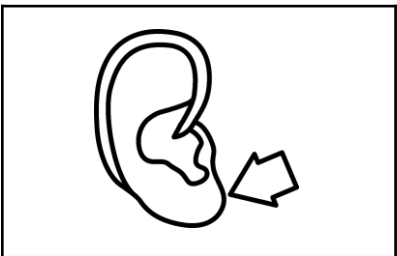

○ ○ ○ (e)
□ □ □ (e)

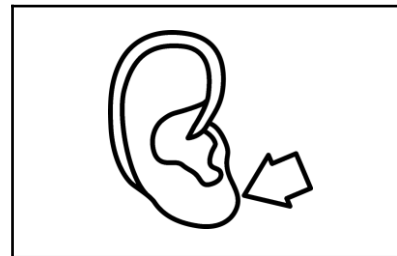

Fold here.

Name: _____

CVCe Encoding Practice

Directions: Say, tap, map, and graph the words.

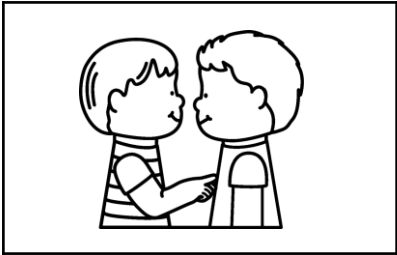

○ ○ ○ (e)
[] [] [] (e)

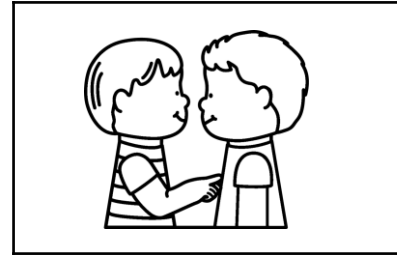

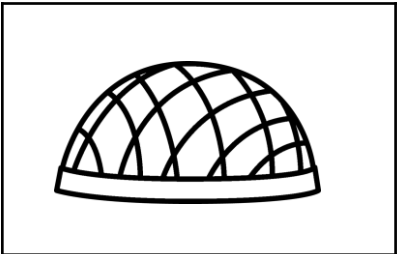

○ ○ ○ (e)
[] [] [] (e)

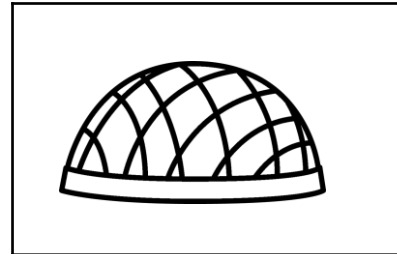

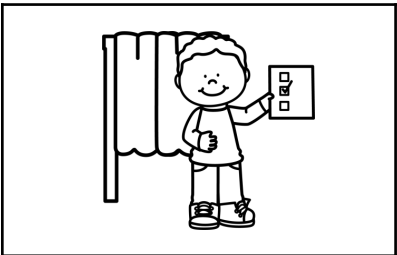

○ ○ ○ (e)
[] [] [] (e)

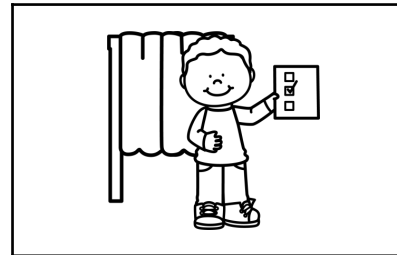

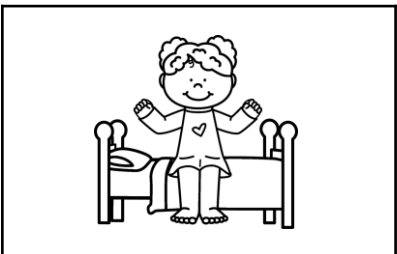

○ ○ ○ (e)
[] [] [] (e)

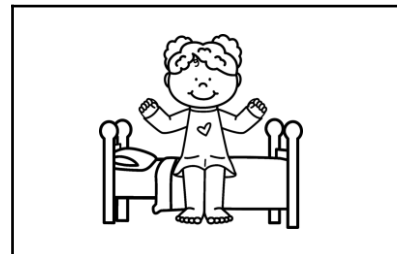

Fold here.

Name: _____

CVCe Encoding Practice

Directions: Say, tap, map, and graph the words.



--	--	--

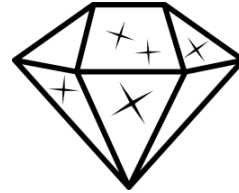

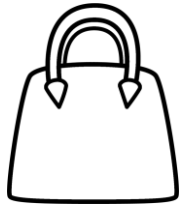

--	--	--





--	--	--





--	--	--



Fold here.

Name: _____

CVCe Encoding Practice

Directions: Say, tap, map, and graph the words.

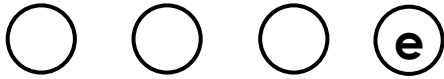

--	--	--

e

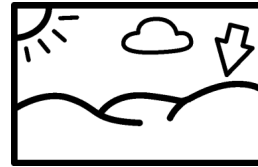



--	--	--

e



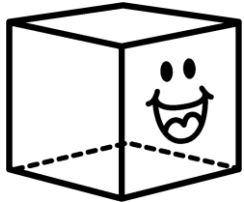

--	--	--

e

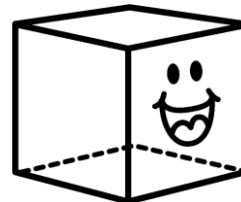



--	--	--

e



Fold here.

Name: _____

CVCe Encoding Practice

Directions: Say, tap, map, and graph the words.

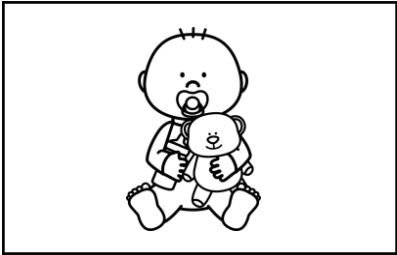

○ ○ ○ (e)
[] [] [] (e)

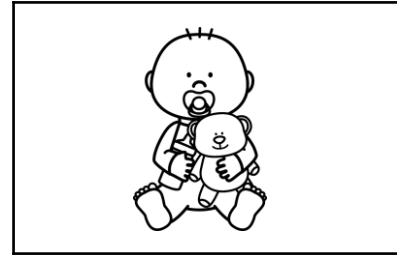

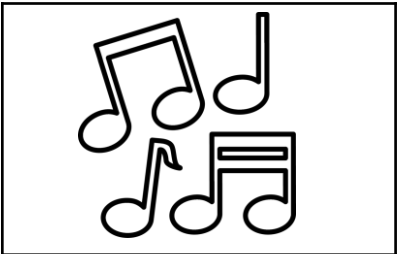

○ ○ ○ (e)
[] [] [] (e)



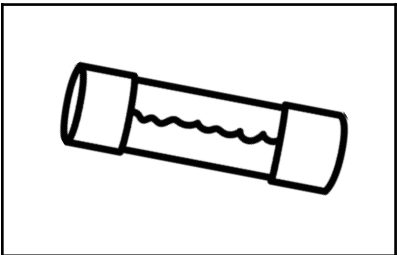

○ ○ ○ (e)
[] [] [] (e)

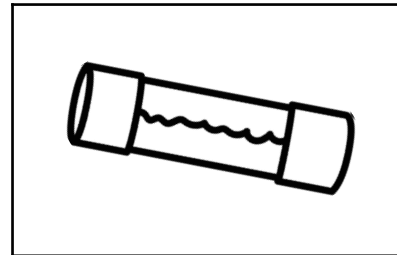

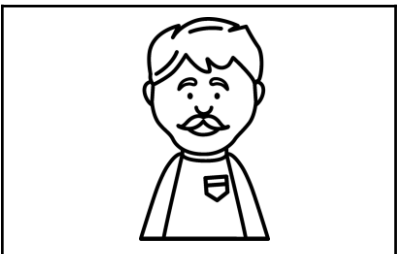

○ ○ ○ (e)
[] [] [] (e)

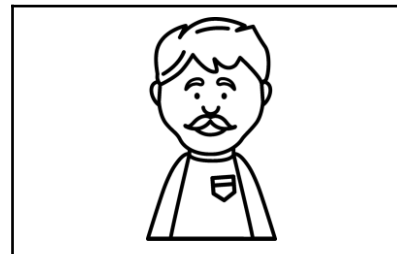

Fold here.

Name: _____

CVCe Encoding Practice

Directions: Say, tap, map, and graph the words.

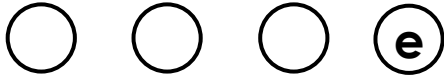

--	--	--

e



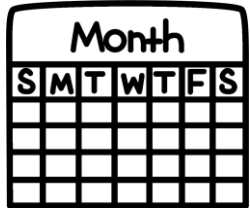

--	--	--

e

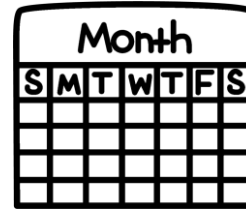



--	--	--

e



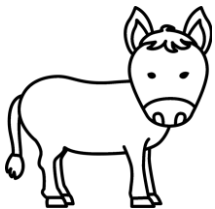

--	--	--

e

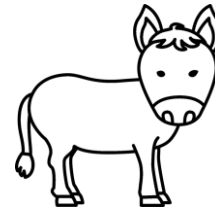

Fold here.

Name: _____

CVCe Encoding Practice

Directions: Say, tap, map, and graph the words.

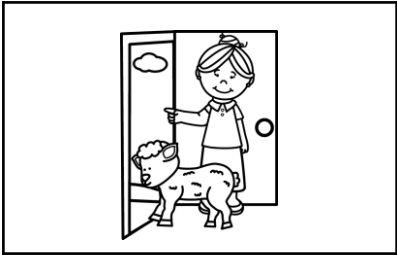

○ ○ ○ (e)
□ □ □

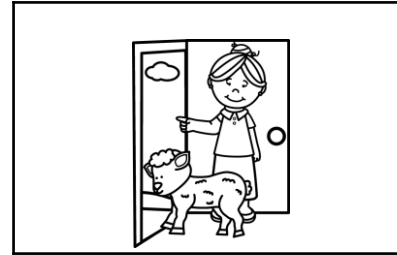

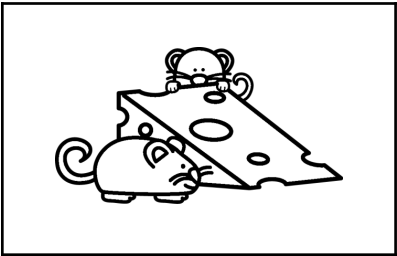

○ ○ ○ (e)
□ □ □

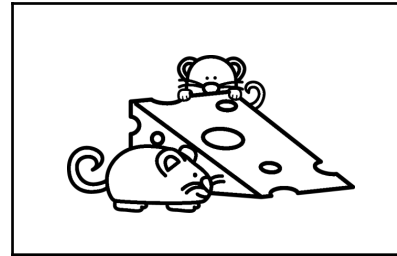

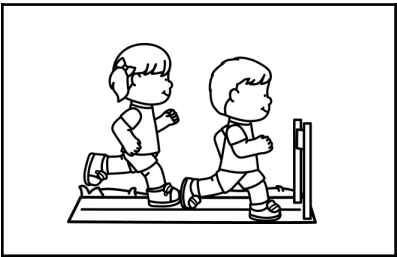

○ ○ ○ (e)
□ □ □

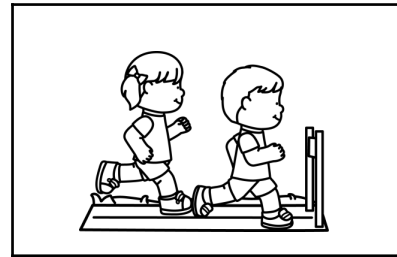



○ ○ ○ (e)
□ □ □

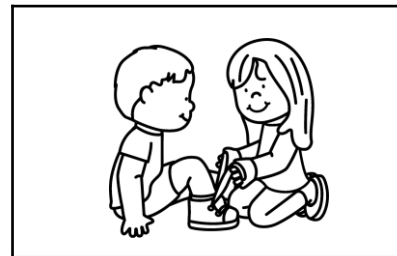

Fold here.

Name: _____

Directions: Say, tap, map, and graph the words.

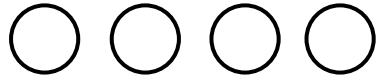
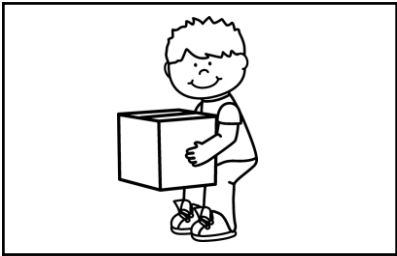

--	--	--	--

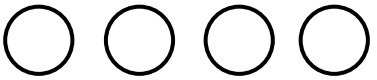
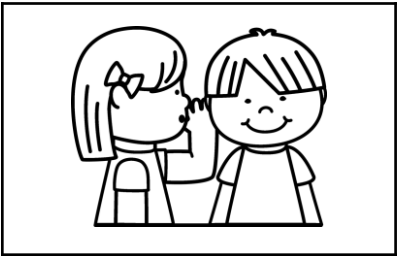

--	--	--	--

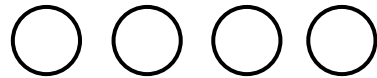
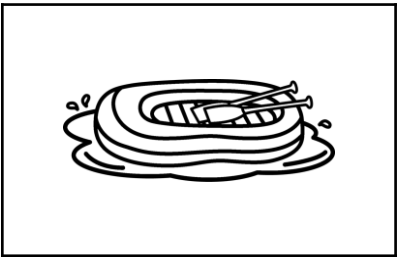

--	--	--	--

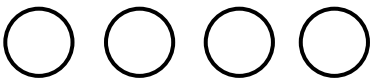

--	--	--	--

Blends Encoding Practice

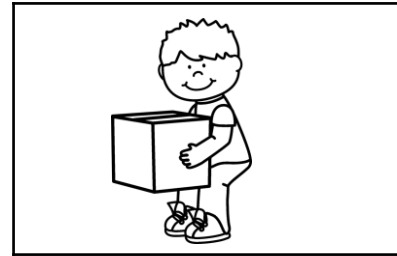

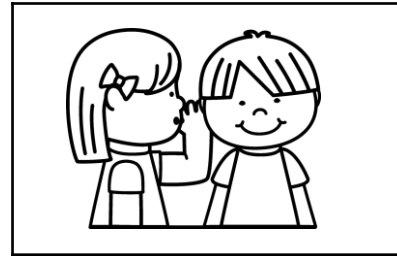

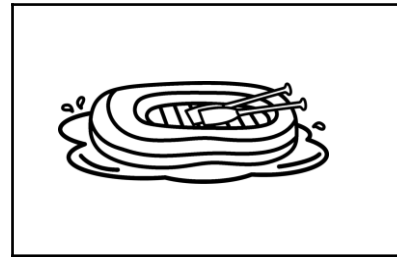



Fold here.

Name: _____

Directions: Say, tap, map, and graph the words.

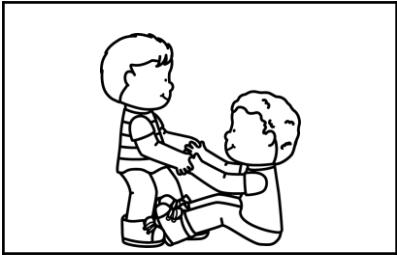

--	--	--	--

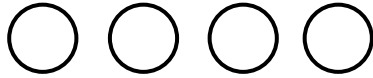

--	--	--	--



--	--	--	--

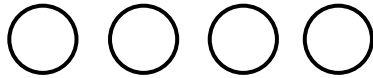

--	--	--	--

Blends Encoding Practice

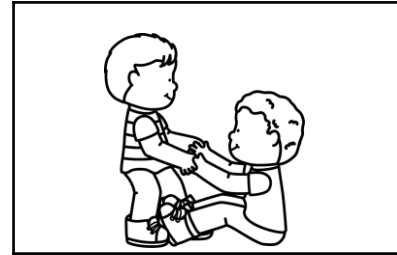



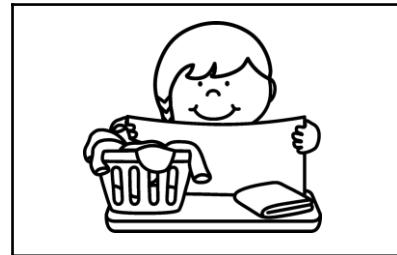



Fold here.

Name: _____

Directions: Say, tap, map, and graph the words.

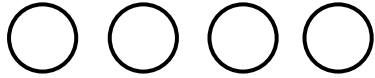

--	--	--	--

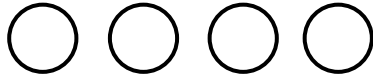

--	--	--	--

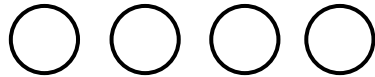

--	--	--	--

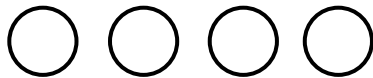

--	--	--	--

Blends Encoding Practice









Fold here.

Name: _____

Directions: Say, tap, map, and graph the words.

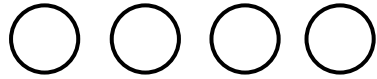

--	--	--	--

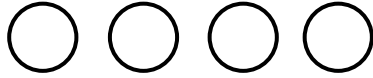

--	--	--	--

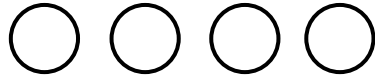

--	--	--	--

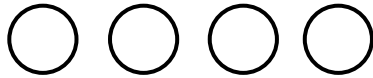

--	--	--	--

Blends Encoding Practice









Fold here.

Name: _____

Directions: Say, tap, map, and graph the words.

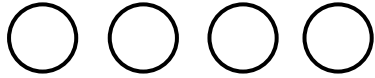
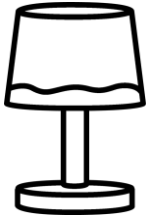

--	--	--	--

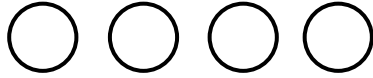
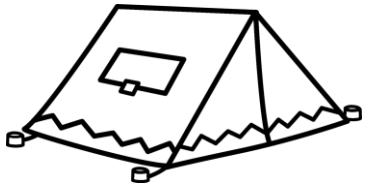

--	--	--	--

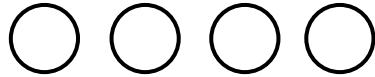

--	--	--	--

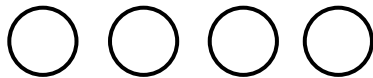
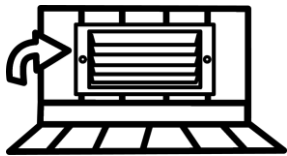

--	--	--	--

Blends Encoding Practice

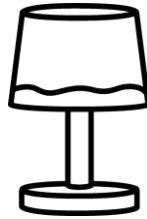

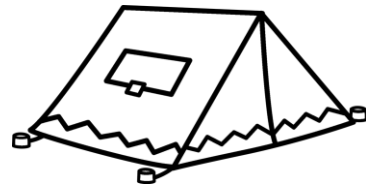



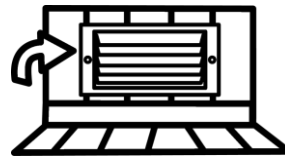

Fold here.

Name: _____

Directions: Say, tap, map, and graph the words.

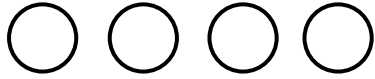
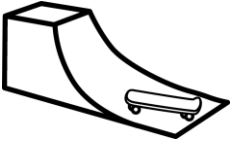

--	--	--	--



--	--	--	--

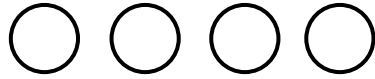

--	--	--	--

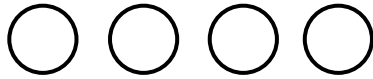

--	--	--	--

Blends Encoding Practice

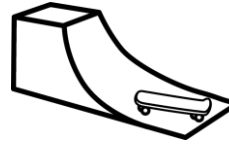







Fold here.

Name: _____

Directions: Say, tap, map, and graph the words.



--	--	--	--

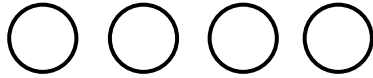

--	--	--	--



--	--	--	--

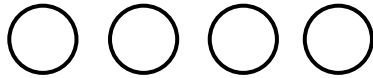

--	--	--	--

Blends Encoding Practice









Fold here.

Name: _____

Directions: Say, tap, map, and graph the words.

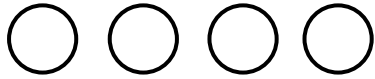
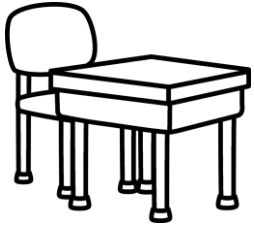

--	--	--	--

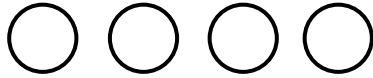

--	--	--	--

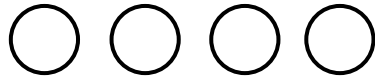

--	--	--	--

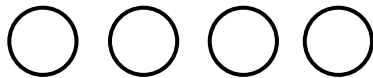

--	--	--	--

Blends Encoding Practice

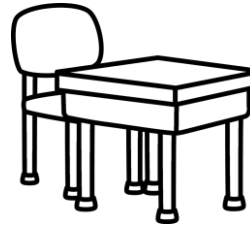







Fold here.

Name: _____

Directions: Say, tap, map, and graph the words.

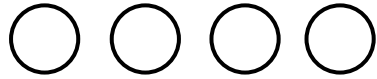
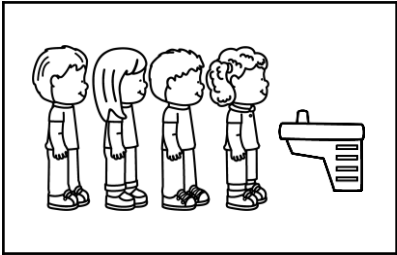

--	--	--	--

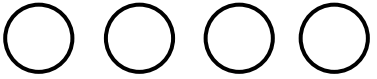
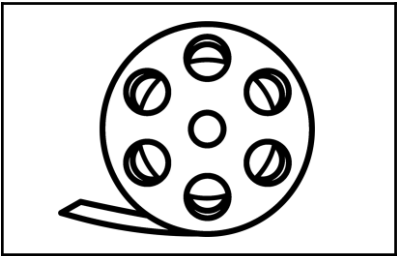

--	--	--	--

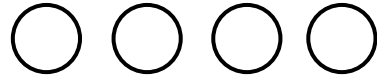
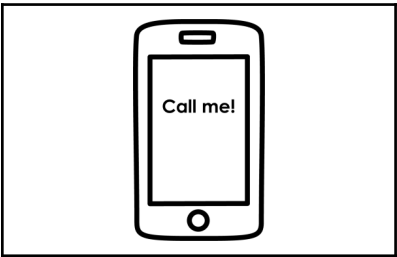

--	--	--	--

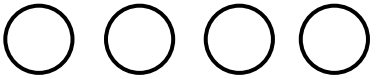
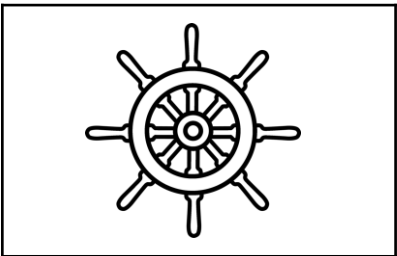

--	--	--	--

Blends Encoding Practice

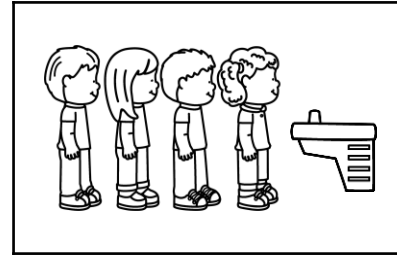

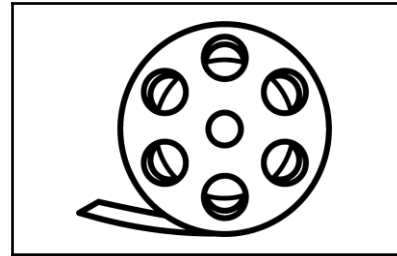

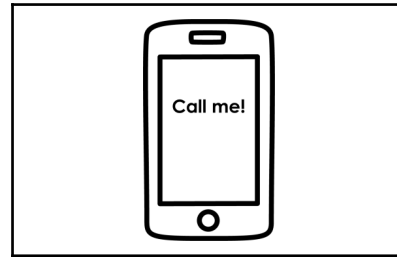

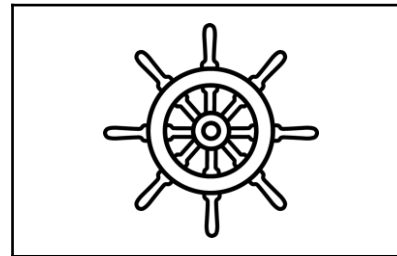

Fold here.

Name: _____

Directions: Say, tap, map, and graph the words.

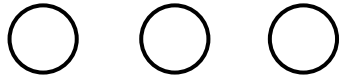

--	--	--

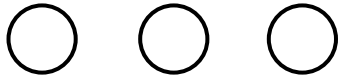

--	--	--

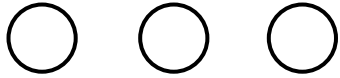

--	--	--

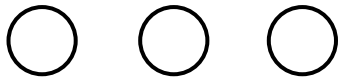

--	--	--

R-Control Encoding Practice

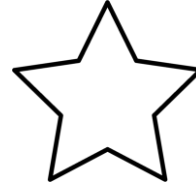



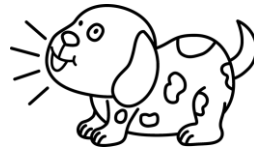



Fold here.

Name: _____

Directions: Say, tap, map, and graph the words.

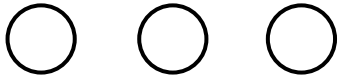
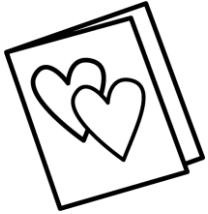

--	--	--

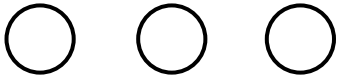

--	--	--

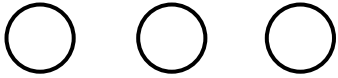

--	--	--

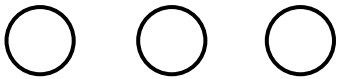

--	--	--

R-Control Encoding Practice

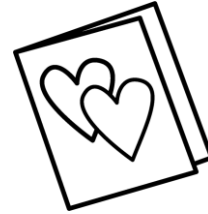

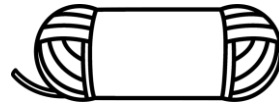





Fold here.

Name: _____

Directions: Say, tap, map, and graph the words.

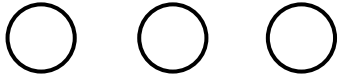
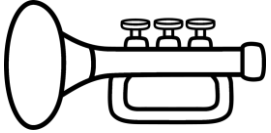

--	--	--

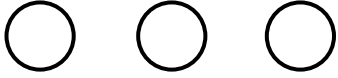

--	--	--

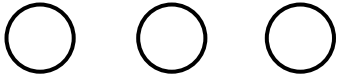
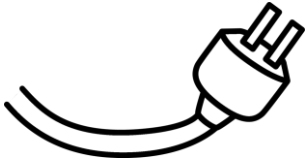

--	--	--

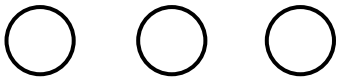
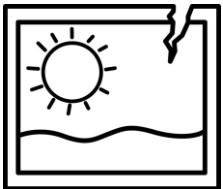

--	--	--

R-Control Encoding Practice

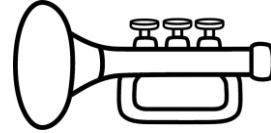



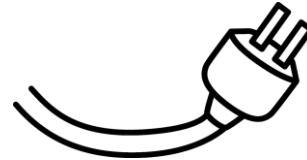

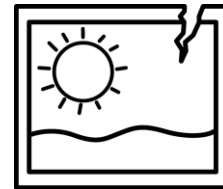

Fold here.

Name: _____

Directions: Say, tap, map, and graph the words.

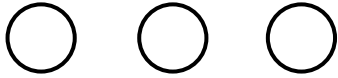

--	--	--

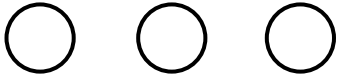

--	--	--

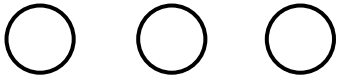
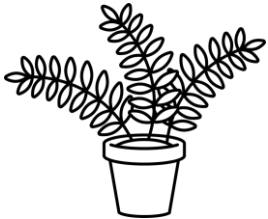

--	--	--

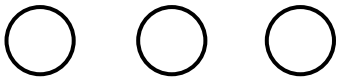
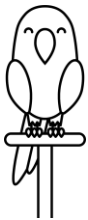

--	--	--

R-Control Encoding Practice









Fold here.

Name: _____

Directions: Say, tap, map, and graph the words.

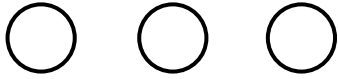
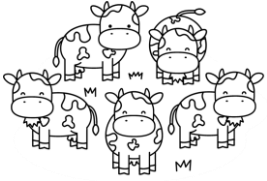

--	--	--

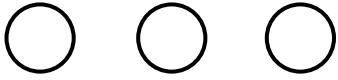

--	--	--

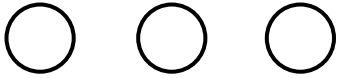

--	--	--

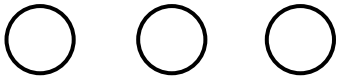
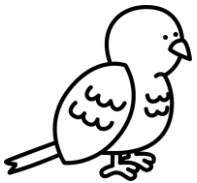

--	--	--

R-Control Encoding Practice

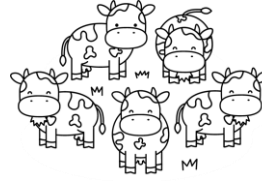





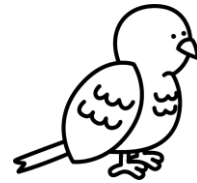

Fold here.

Name: _____

Directions: Say, tap, map, and graph the words.

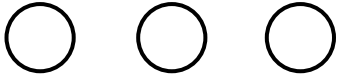
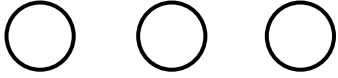
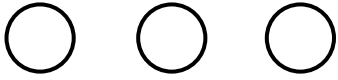
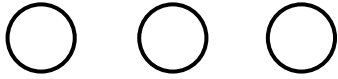
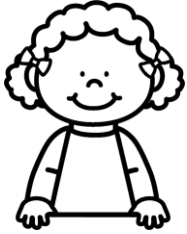

R-Control Encoding Practice

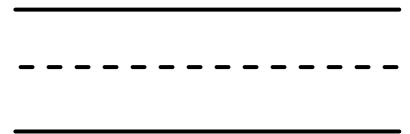
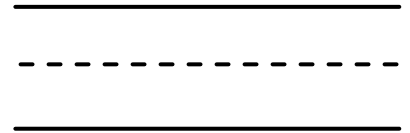
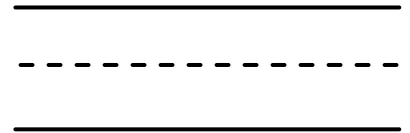
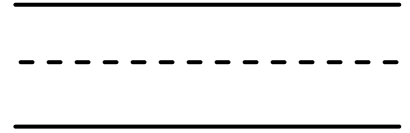

Fold here.

Name: _____

Directions: Say, tap, map, and graph the words.

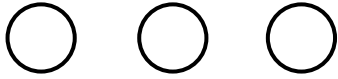
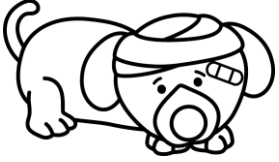

--	--	--

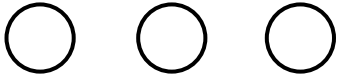
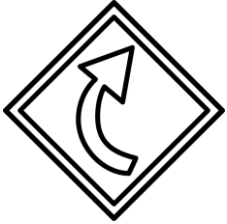

--	--	--

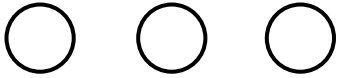
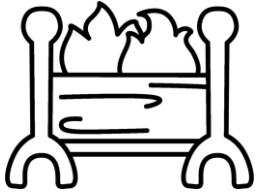

--	--	--

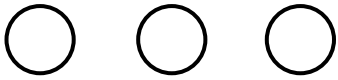
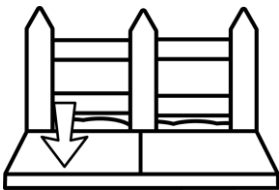

--	--	--

R-Control Encoding Practice

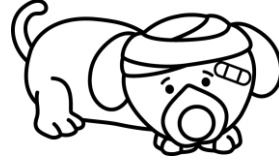

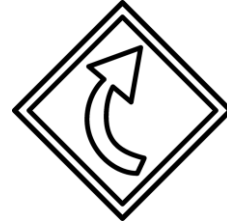

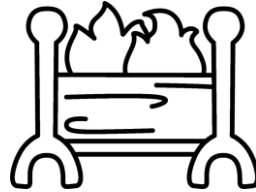

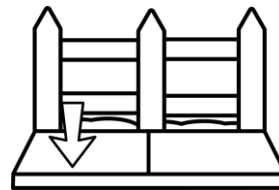

Fold here.

Name: _____

Directions: Say, tap, map, and graph the words.

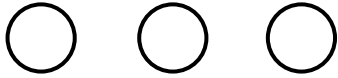
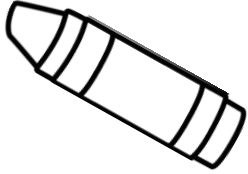

--	--	--

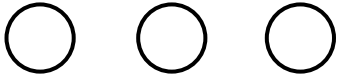

--	--	--

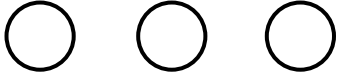

--	--	--

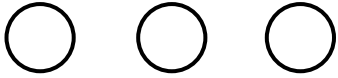

--	--	--

Vowel Teams Encoding Practice

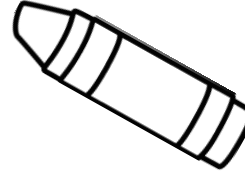







Fold here.

Name: _____

Directions: Say, tap, map, and graph the words.

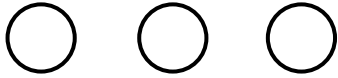
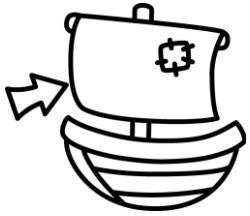

--	--	--

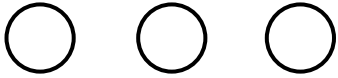

--	--	--

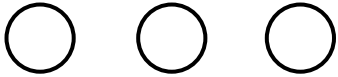
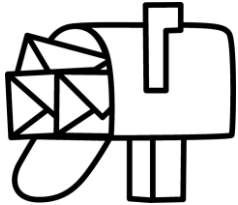

--	--	--

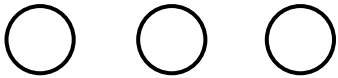
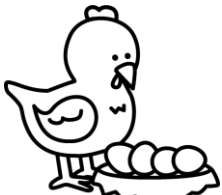

--	--	--

Fold here.

Vowel Teams Encoding Practice

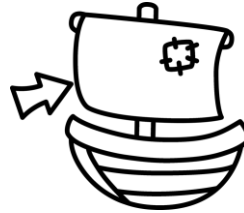



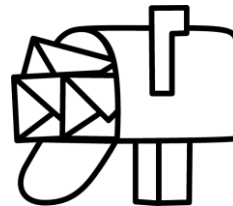

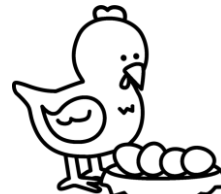

Name: _____

Directions: Say, tap, map, and graph the words.

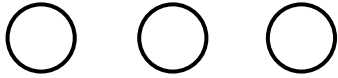

--	--	--

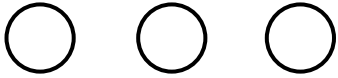

--	--	--

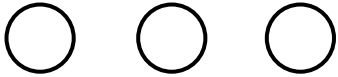

--	--	--

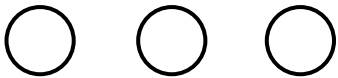

--	--	--

Vowel Teams Encoding Practice







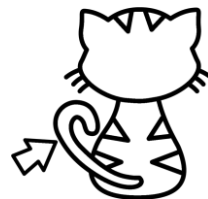

Fold here.

Name: _____

Vowel Teams Encoding Practice

Directions: Say, tap, map, and graph the words.

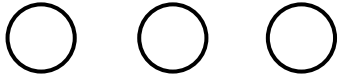

--	--	--



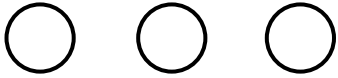
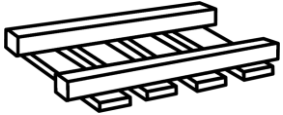

--	--	--

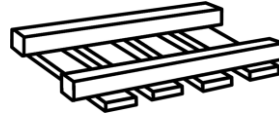

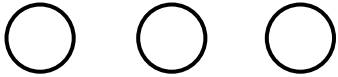
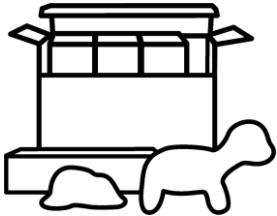

--	--	--

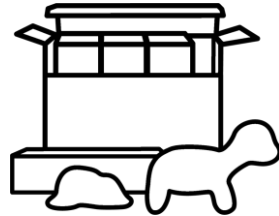

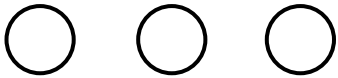

--	--	--



Fold here.

Name: _____

Directions: Say, tap, map, and graph the words.

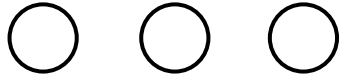

--	--	--

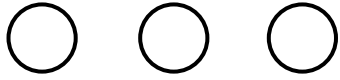
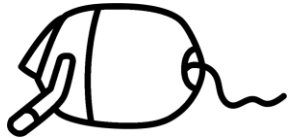

--	--	--

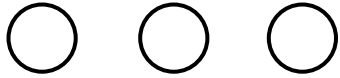

--	--	--

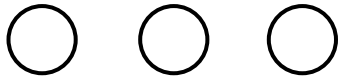

--	--	--

Fold here.

Vowel Teams Encoding Practice



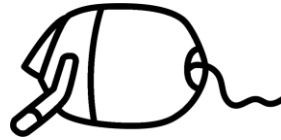





Name: _____

Directions: Say, tap, map, and graph the words.

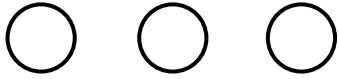
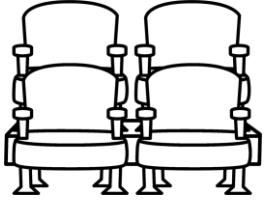

--	--	--

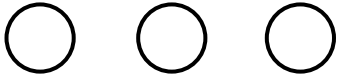

--	--	--

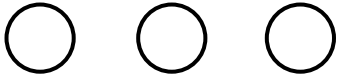

--	--	--

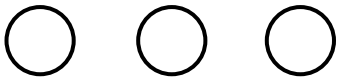
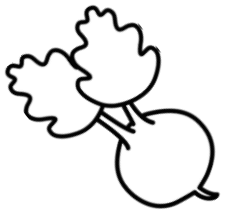

--	--	--

Fold here.

Vowel Teams Encoding Practice

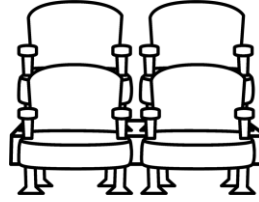





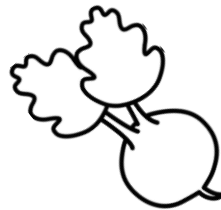

Name: _____

Directions: Say, tap, map, and graph the words.

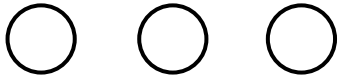

--	--	--

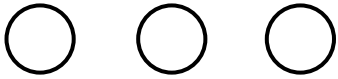

--	--	--

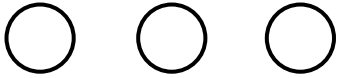
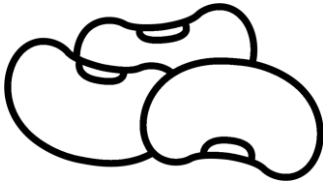

--	--	--

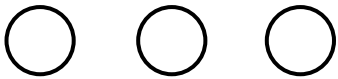

--	--	--

Vowel Teams Encoding Practice





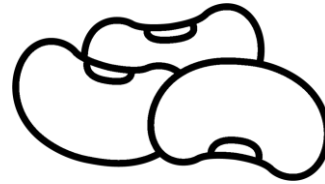



Fold here.

Name: _____

Directions: Say, tap, map, and graph the words.

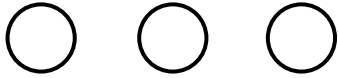

--	--	--

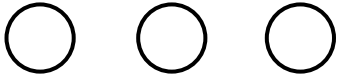

--	--	--

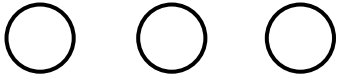
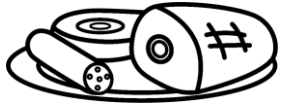

--	--	--

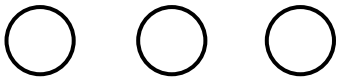

--	--	--

Fold here.

Vowel Teams Encoding Practice





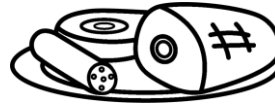



Name: _____

Vowel Teams Encoding Practice

Directions: Say, tap, map, and graph the words.

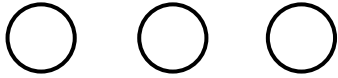
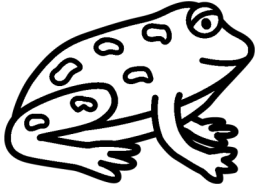

--	--	--

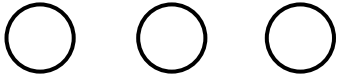
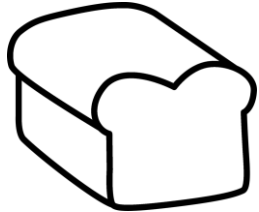

--	--	--

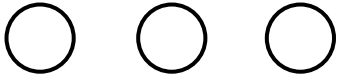
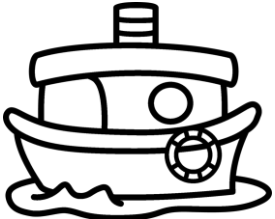

--	--	--

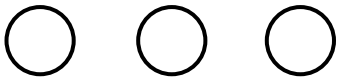

--	--	--

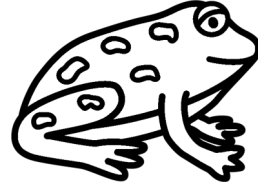

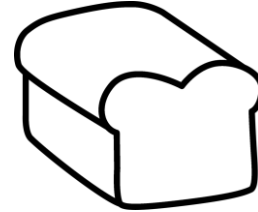

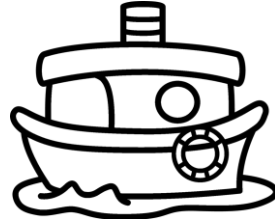

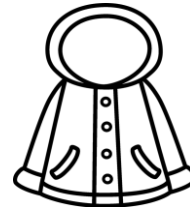

Fold here.

Name: _____

Directions: Say, tap, map, and graph the words.

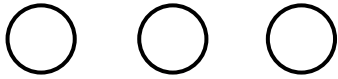

--	--	--

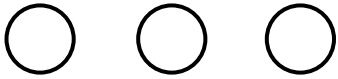
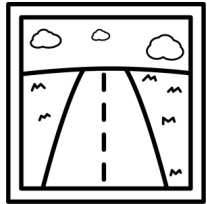

--	--	--

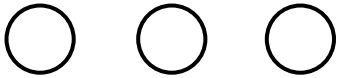
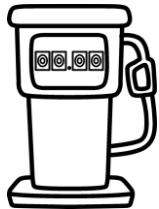

--	--	--

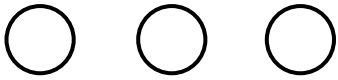
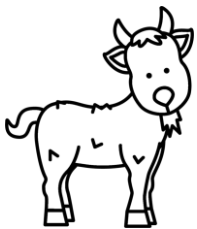

--	--	--

Fold here.

Vowel Teams Encoding Practice





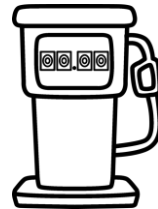

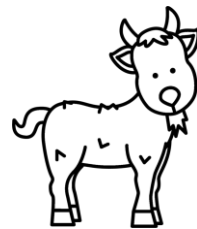

Name: _____

Directions: Say, tap, map, and graph the words.

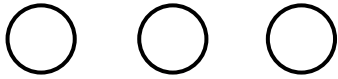
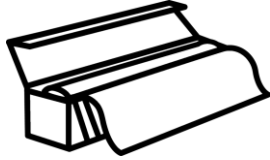

--	--	--

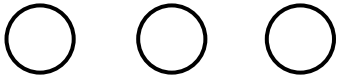
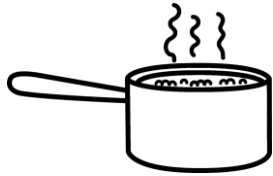

--	--	--

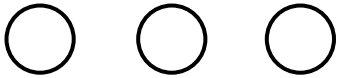

--	--	--

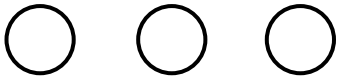
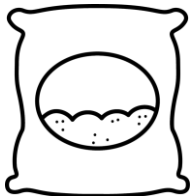

--	--	--

Fold here.

Vowel Teams Encoding Practice

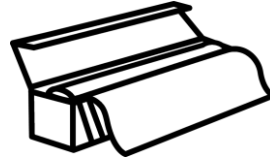

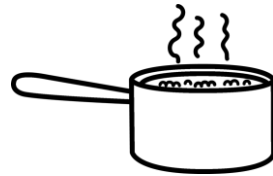



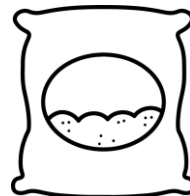

Name: _____

Directions: Say, tap, map, and graph the words.

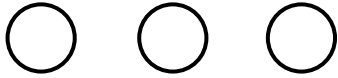

--	--	--

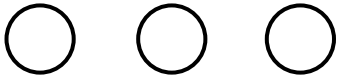
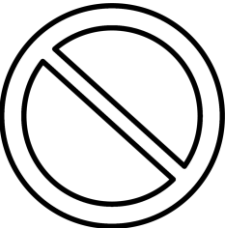

--	--	--

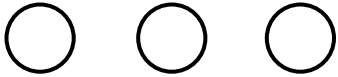

--	--	--

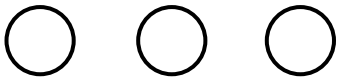
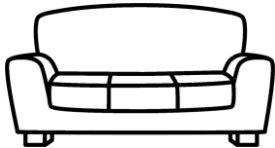

--	--	--

Vowel Teams Encoding Practice

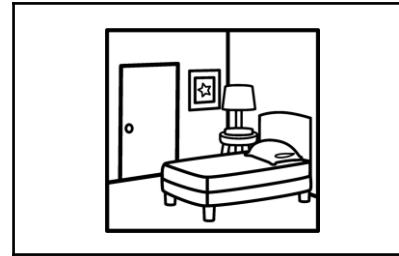

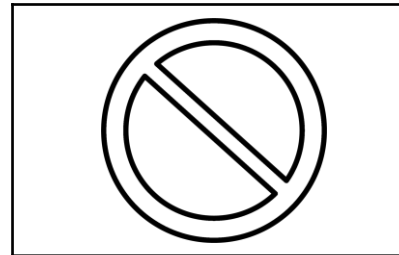



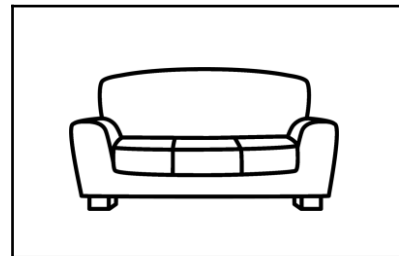

Fold here.

Name: _____

Vowel Teams Encoding Practice

Directions: Say, tap, map, and graph the words.

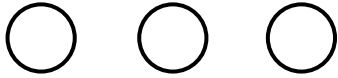

--	--	--



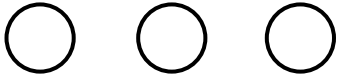

--	--	--



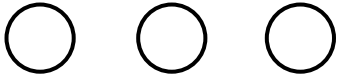

--	--	--



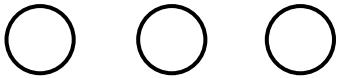
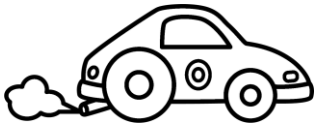

--	--	--

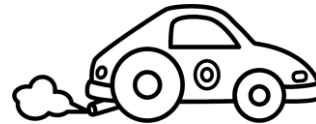

Fold here.

Name: _____

Directions: Say, tap, map, and graph the words.

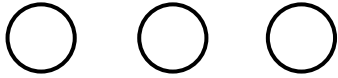

--	--	--

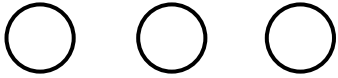
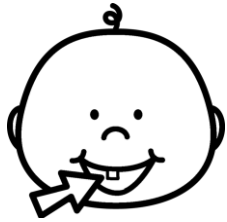

--	--	--

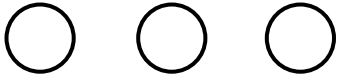

--	--	--

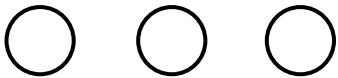
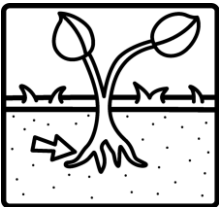

--	--	--

Fold here.

Vowel Teams Encoding Practice



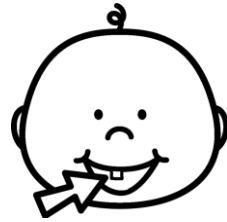



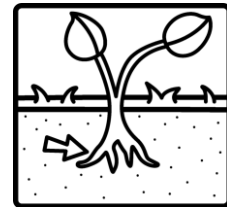

Name: _____

Directions: Say, tap, map, and graph the words.

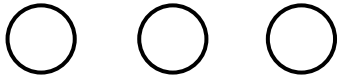
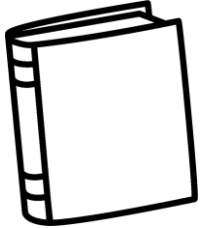

--	--	--

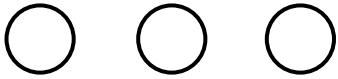

--	--	--

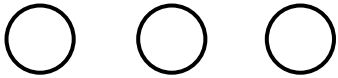

--	--	--

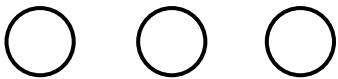

--	--	--

Fold here.

Vowel Teams Encoding Practice

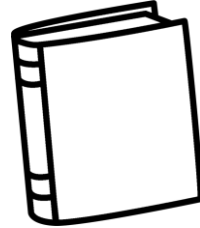







Name:

Date:

A	B	C	D	E	F	G	H	I	J	K	L	M	N	O	P	Q	R	S	T	U	V	W	X	Y	Z
---	---	---	---	---	---	---	---	---	---	---	---	---	---	---	---	---	---	---	---	---	---	---	---	---	---

a	b	c	d	e	f	g	h	i	j	k	l	m	n	o	p	q	r	s	t	u	v	w	x	y	z
---	---	---	---	---	---	---	---	---	---	---	---	---	---	---	---	---	---	---	---	---	---	---	---	---	---

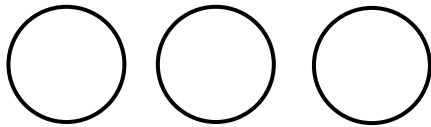
Tap It! 

Map It!

--	--	--

Name:

Date:

A	B	C	D	E	F	G	H	I	J	K	L	M	N	O	P	Q	R	S	T	U	V	W	X	Y	Z
---	---	---	---	---	---	---	---	---	---	---	---	---	---	---	---	---	---	---	---	---	---	---	---	---	---

a	b	c	d	e	f	g	h	i	j	k	l	m	n	o	p	q	r	s	t	u	v	w	x	y	z
---	---	---	---	---	---	---	---	---	---	---	---	---	---	---	---	---	---	---	---	---	---	---	---	---	---

Tap It! ○ ○ ○

Map It!

--	--	--

Handwriting practice lines consisting of two sets of three horizontal lines each. Each set includes a solid top line, a dashed middle line, and a solid bottom line.

Name:

Date:

A	B	C	D	E	F	G	H	I	J	K	L	M	N	O	P	Q	R	S	T	U	V	W	X	Y	Z
---	---	---	---	---	---	---	---	---	---	---	---	---	---	---	---	---	---	---	---	---	---	---	---	---	---

a	b	c	d	e	f	g	h	i	j	k	l	m	n	o	p	q	r	s	t	u	v	w	x	y	z
---	---	---	---	---	---	---	---	---	---	---	---	---	---	---	---	---	---	---	---	---	---	---	---	---	---

Tap It! ○ ○ ○



























Map It!

--	--	--

Handwriting practice lines consisting of four sets of three horizontal lines each: a solid top line, a dashed middle line, and a solid bottom line.

Name:

Date:

a 	b 	c 	d 	e 	f 	g 	h 	i 	j 	k 	l 	m 
n 	o 	p 	q 	r 	s 	t 	u 	v 	w 	x 	y 	z 

Tap It!

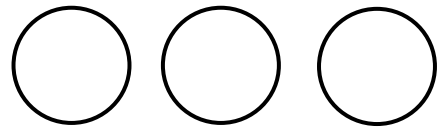



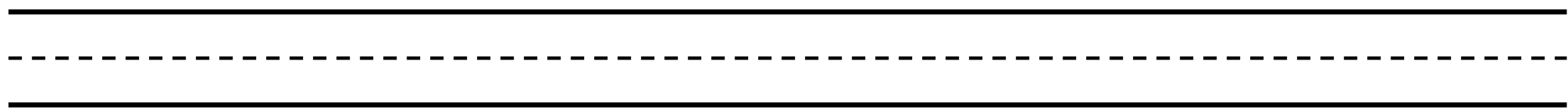
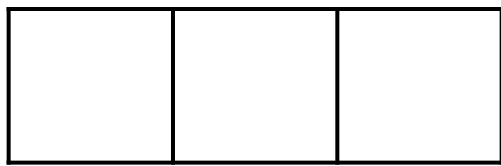























Map It!



Name:

Date:

a 	b 	c 	d 	e 	f 	g 	h 	i 	j 	k 	l 	m 
n 	o 	p 	q 	r 	s 	t 	u 	v 	w 	x 	y 	z 

Tap It!

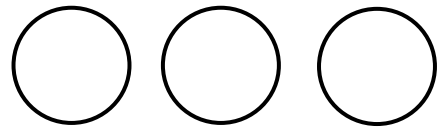



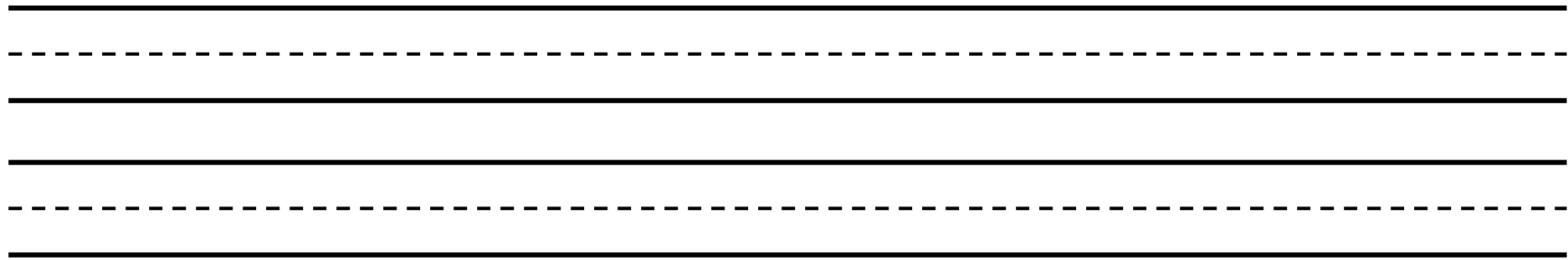
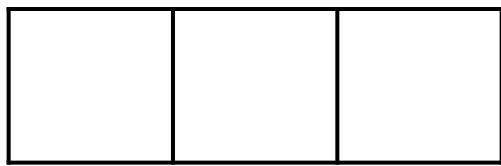























Map It!



Name:

Date:

a 	b 	c 	d 	e 	f 	g 	h 	i 	j 	k 	l 	m 
n 	o 	p 	q 	r 	s 	t 	u 	v 	w 	x 	y 	z 

Tap It!

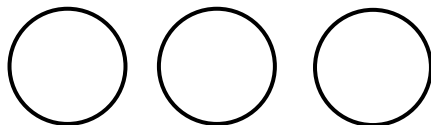

Map It!



Handwriting practice lines consisting of three sets of solid top and bottom lines with a dashed middle line.

Name:

Date:

A	B	C	D	E	F	G	H	I	J	K	L	M	N	O	P	Q	R	S	T	U	V	W	X	Y	Z
---	---	---	---	---	---	---	---	---	---	---	---	---	---	---	---	---	---	---	---	---	---	---	---	---	---

a	b	c	d	e	f	g	h	i	j	k	l	m	n	o	p	q	r	s	t	u	v	w	x	y	z
---	---	---	---	---	---	---	---	---	---	---	---	---	---	---	---	---	---	---	---	---	---	---	---	---	---

Tap It!

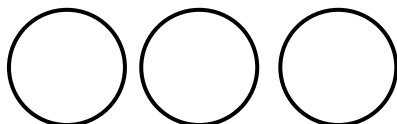

Map It!



	like	see
	look	the

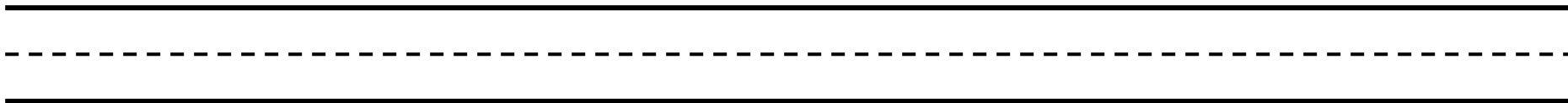

Name:

Date:

A	B	C	D	E	F	G	H	I	J	K	L	M	N	O	P	Q	R	S	T	U	V	W	X	Y	Z
---	---	---	---	---	---	---	---	---	---	---	---	---	---	---	---	---	---	---	---	---	---	---	---	---	---

a	b	c	d	e	f	g	h	i	j	k	l	m	n	o	p	q	r	s	t	u	v	w	x	y	z
---	---	---	---	---	---	---	---	---	---	---	---	---	---	---	---	---	---	---	---	---	---	---	---	---	---

Tap It! ○ ○ ○

Map It!

--	--	--

	like	see
	look	the

Name:

Date:

A	B	C	D	E	F	G	H	I	J	K	L	M	N	O	P	Q	R	S	T	U	V	W	X	Y	Z
---	---	---	---	---	---	---	---	---	---	---	---	---	---	---	---	---	---	---	---	---	---	---	---	---	---

a	b	c	d	e	f	g	h	i	j	k	l	m	n	o	p	q	r	s	t	u	v	w	x	y	z
---	---	---	---	---	---	---	---	---	---	---	---	---	---	---	---	---	---	---	---	---	---	---	---	---	---

Tap It! ○ ○ ○

Map It!

--	--	--

	like	see
	look	the

Handwriting practice lines consisting of three sets of solid top and bottom lines with a dashed middle line.

Generic Writing Paper

Name:

Date:

A	B	C	D	E	F	G	H	I	J	K	L	M	N	O	P	Q	R	S	T	U	V	W	X	Y	Z
---	---	---	---	---	---	---	---	---	---	---	---	---	---	---	---	---	---	---	---	---	---	---	---	---	---

a	b	c	d	e	f	g	h	i	j	k	l	m	n	o	p	q	r	s	t	u	v	w	x	y	z
---	---	---	---	---	---	---	---	---	---	---	---	---	---	---	---	---	---	---	---	---	---	---	---	---	---

Name:

Date:

A	B	C	D	E	F	G	H	I	J	K	L	M	N	O	P	Q	R	S	T	U	V	W	X	Y	Z
---	---	---	---	---	---	---	---	---	---	---	---	---	---	---	---	---	---	---	---	---	---	---	---	---	---

a	b	c	d	e	f	g	h	i	j	k	l	m	n	o	p	q	r	s	t	u	v	w	x	y	z
---	---	---	---	---	---	---	---	---	---	---	---	---	---	---	---	---	---	---	---	---	---	---	---	---	---

Handwriting practice lines consisting of two sets of three horizontal lines each. Each set includes a solid top line, a dashed middle line, and a solid bottom line.

Name:

Date:



























A	B	C	D	E	F	G	H	I	J	K	L	M	N	O	P	Q	R	S	T	U	V	W	X	Y	Z
---	---	---	---	---	---	---	---	---	---	---	---	---	---	---	---	---	---	---	---	---	---	---	---	---	---

a	b	c	d	e	f	g	h	i	j	k	l	m	n	o	p	q	r	s	t	u	v	w	x	y	z
---	---	---	---	---	---	---	---	---	---	---	---	---	---	---	---	---	---	---	---	---	---	---	---	---	---

Handwriting practice lines consisting of four sets of three horizontal lines each. Each set includes a solid top line, a dashed middle line, and a solid bottom line.



























Name:

Date:

a 	b 	c 	d 	e 	f 	g 	h 	i 	j 	k 	l 	m 
n 	o 	p 	q 	r 	s 	t 	u 	v 	w 	x 	y 	z 

Name:



























Date:

a 	b 	c 	d 	e 	f 	g 	h 	i 	j 	k 	l 	m 
n 	o 	p 	q 	r 	s 	t 	u 	v 	w 	x 	y 	z 

Handwriting practice lines consisting of two sets of three horizontal lines each. Each set includes a solid top line, a dashed middle line, and a solid bottom line.

Name:

Date:

a 	b 	c 	d 	e 	f 	g 	h 	i 	j 	k 	l 	m 
n 	o 	p 	q 	r 	s 	t 	u 	v 	w 	x 	y 	z 

Handwriting practice lines consisting of four sets of three horizontal lines (top solid, middle dashed, bottom solid).

Portrait Writing Paper

Name:

Date:

A	B	C	D	E	F	G	H	I	J	K	L	M	N	O	P	Q	R	S	T	U	V	W	X	Y	Z
a	b	c	d	e	f	g	h	i	j	k	l	m	n	o	p	q	r	s	t	u	v	w	x	y	z

Tap It! ○ ○ ○

Map It!

--	--	--

Name:

Date:

A	B	C	D	E	F	G	H	I	J	K	L	M	N	O	P	Q	R	S	T	U	V	W	X	Y	Z
a	b	c	d	e	f	g	h	i	j	k	l	m	n	o	p	q	r	s	t	u	v	w	x	y	z

Tap It! ○ ○ ○

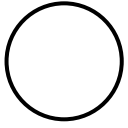

Map It!

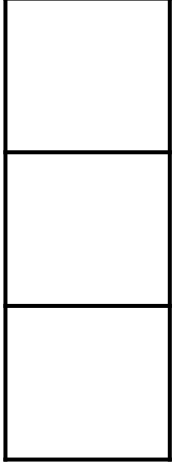

Handwriting practice lines consisting of a solid top line, a dashed middle line, and a solid bottom line, repeated three times.

Name:

Date:

A	B	C	D	E	F	G	H	I	J	K	L	M	N	O	P	Q	R	S	T	U	V	W	X	Y	Z
a	b	c	d	e	f	g	h	i	j	k	l	m	n	o	p	q	r	s	t	u	v	w	x	y	z

Tap It! ○ ○ ○

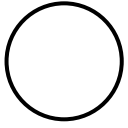

Map It!

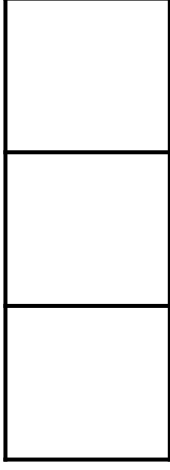

Handwriting practice lines consisting of three sets of solid top and bottom lines with a dashed middle line.

Name:

Date:

A	B	C	D	E	F	G	H	I	J	K	L	M	N	O	P	Q	R	S	T	U	V	W	X	Y	Z
a	b	c	d	e	f	g	h	i	j	k	l	m	n	o	p	q	r	s	t	u	v	w	x	y	z

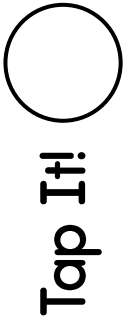

Tap It!

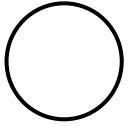

Map It!

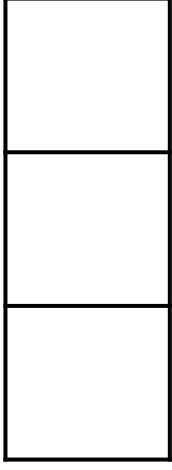

Handwriting practice lines consisting of four sets of three horizontal lines each. Each set includes a solid top line, a dashed middle line, and a solid bottom line.

Name:

Date:

A	B	C	D	E	F	G	H	I	J	K	L	M	N	O	P	Q	R	S	T	U	V	W	X	Y	Z
a	b	c	d	e	f	g	h	i	j	k	l	m	n	o	p	q	r	s	t	u	v	w	x	y	z

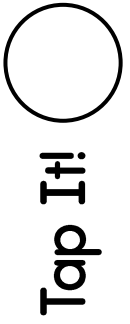

Tap It!

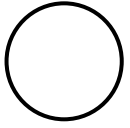

Map It!

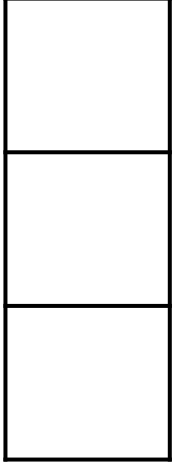

Handwriting practice lines consisting of four sets of three horizontal lines (top solid, middle dashed, bottom solid).

Name:

Date:

A B C D E F G H I J K L M N O P Q R S T U V W X Y Z

a b c d e f g h i j k l m n o p q r s t u v w x y z

Tap It! ○ ○ ○ ○ Map It!

--	--	--

like	see
look	the



Name:

Date:

A B C D E F G H I J K L M N O P Q R S T U V W X Y Z

a b c d e f g h i j k l m n o p q r s t u v w x y z

Tap It! ○ ○ ○ ○

Map It!

--	--	--

like	see
look	the

Name:

Date:

A B C D E F G H I J K L M N O P Q R S T U V W X Y Z

a b c d e f g h i j k l m n o p q r s t u v w x y z

Tap It! ○ ○ ○ ○

Map It!

--	--	--

like	see
look	the

Handwriting practice lines consisting of four sets of three horizontal lines: a solid top line, a dashed middle line, and a solid bottom line.

Name:

Date:

A B C D E F G H I J K L M N O P Q R S T U V W X Y Z

a b c d e f g h i j k l m n o p q r s t u v w x y z

like	see
look	the

--	--	--

Tap It! ○ ○ ○ Map It!

Handwriting practice lines consisting of solid top and bottom lines with a dashed middle line. There are four sets of these lines.

Name:

Date:

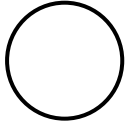
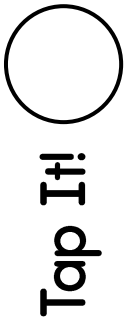
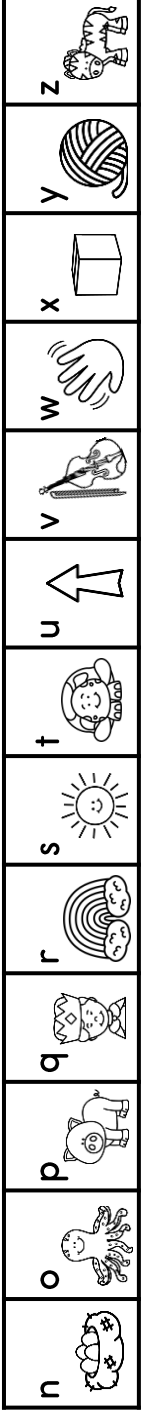
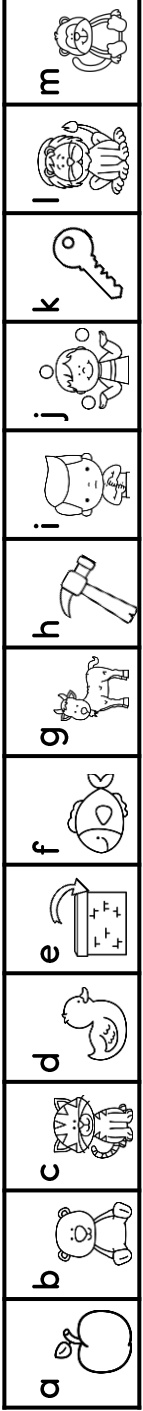

Map It!

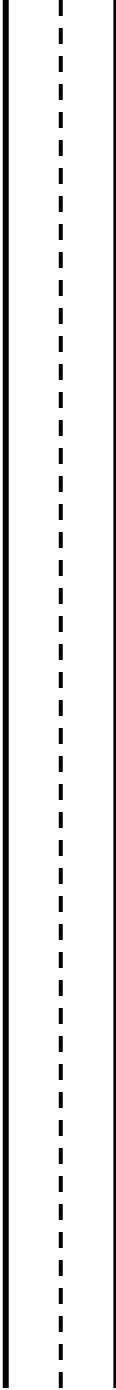
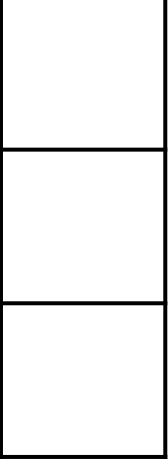

Name:

Date:

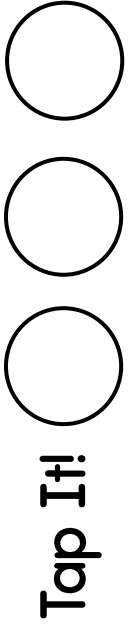
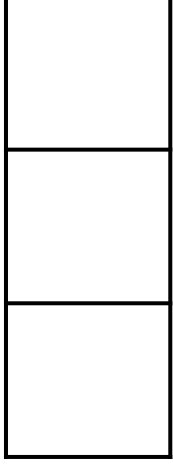
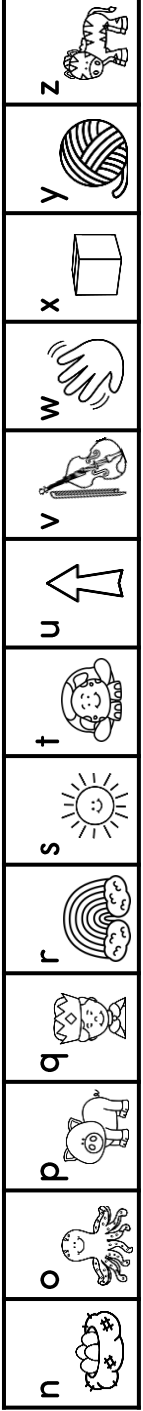
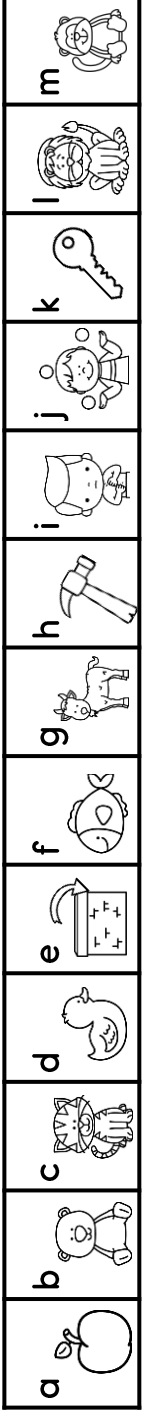

Map It!

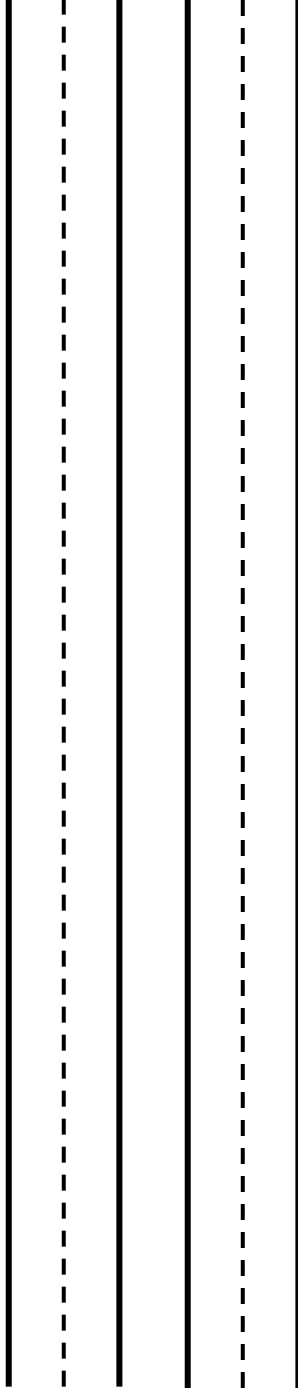

Name:

Date:

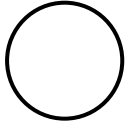
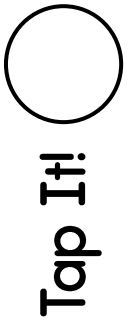
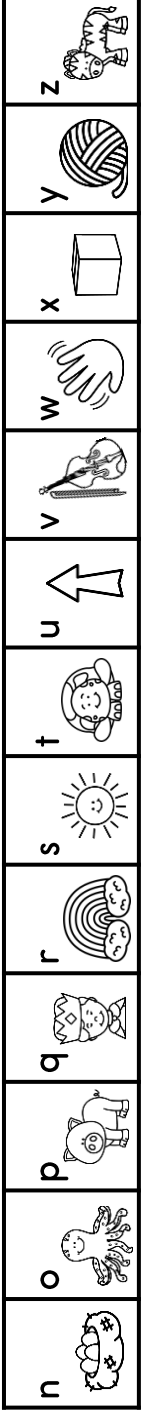
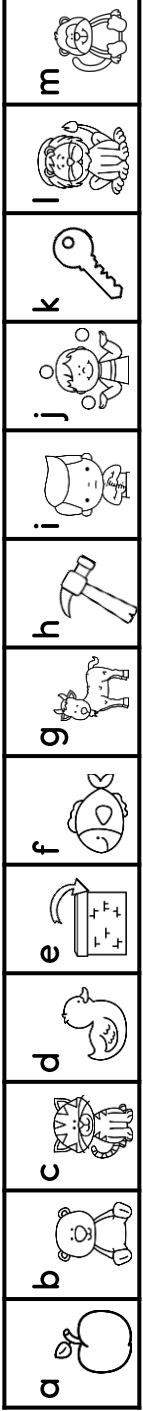



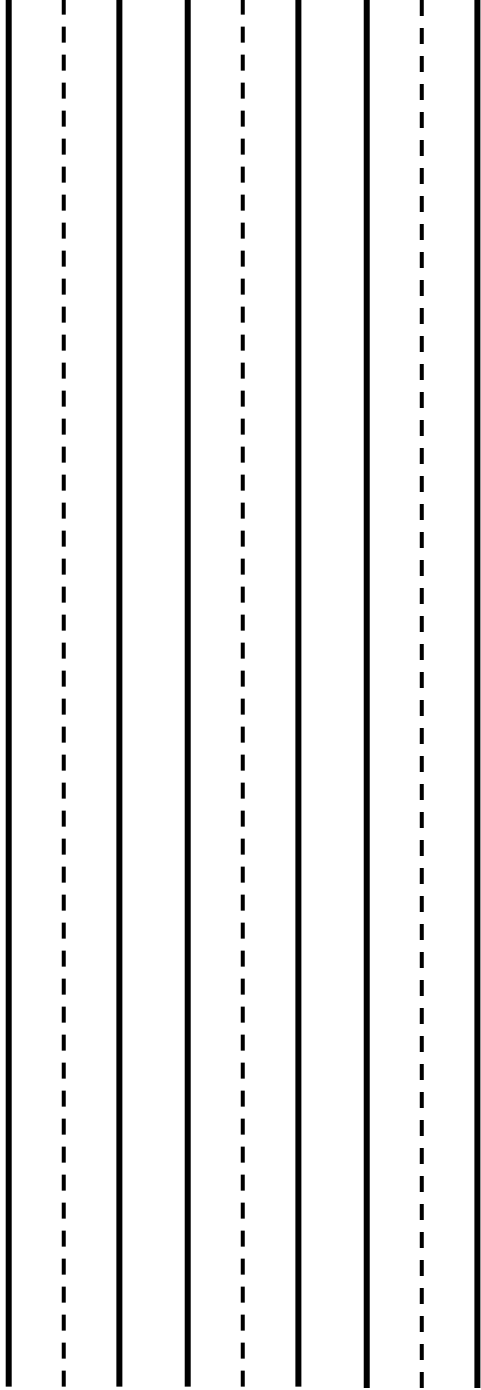
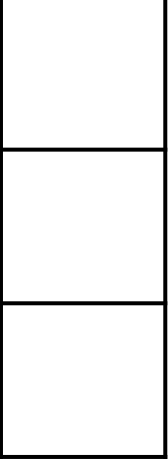























Map It!



Name:

Date:

a	b	c	d	e	f	g	h	i	j	k	l	m
												

n	o	p	q	r	s	t	u	v	w	x	y	z
												

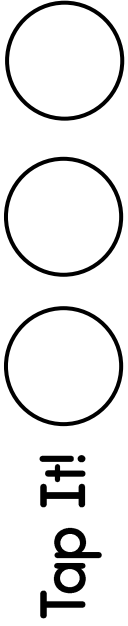

Tap It!



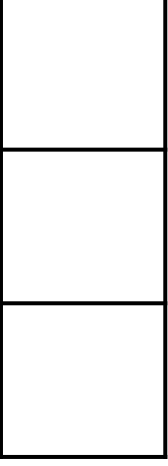























Map It!



Handwriting practice lines consisting of four sets of three lines each: a solid top line, a dashed middle line, and a solid bottom line.

Name:

Date:

a	b	c	d	e	f	g	h	i	j	k	l	m
												
n	o	p	q	r	s	t	u	v	w	x	y	z
												

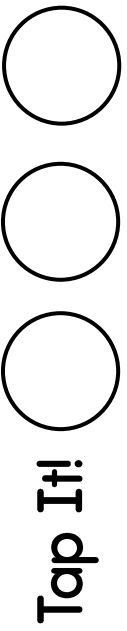

Tap It!

Map It!

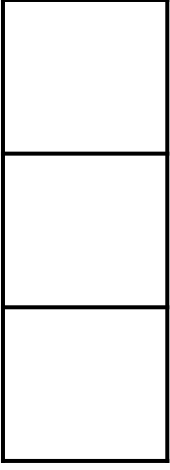

Handwriting practice lines consisting of solid top and bottom lines with a dashed middle line for letter height guidance.

Generic Writing Paper

Name:

Date:

A	B	C	D	E	F	G	H	I	J	K	L	M	N	O	P	Q	R	S	T	U	V	W	X	Y	Z
a	b	c	d	e	f	g	h	i	j	k	l	m	n	o	p	q	r	s	t	u	v	w	x	y	z

Name:

Date:

A	B	C	D	E	F	G	H	I	J	K	L	M	N	O	P	Q	R	S	T	U	V	W	X	Y	Z
a	b	c	d	e	f	g	h	i	j	k	l	m	n	o	p	q	r	s	t	u	v	w	x	y	z

Name:

Date:

A	B	C	D	E	F	G	H	I	J	K	L	M	N	O	P	Q	R	S	T	U	V	W	X	Y	Z
a	b	c	d	e	f	g	h	i	j	k	l	m	n	o	p	q	r	s	t	u	v	w	x	y	z

Blank handwriting practice lines consisting of four sets of three horizontal lines (top solid, middle dashed, bottom solid).

Name:

Date:

A	B	C	D	E	F	G	H	I	J	K	L	M	N	O	P	Q	R	S	T	U	V	W	X	Y	Z
a	b	c	d	e	f	g	h	i	j	k	l	m	n	o	p	q	r	s	t	u	v	w	x	y	z

Handwriting practice lines consisting of four sets of three horizontal lines each. Each set includes a solid top line, a dashed middle line, and a solid bottom line.

Name:

Date:













































A	B	C	D	E	F	G	H	I	J	K	L	M	N	O	P	Q	R	S	T	U	V	W	X	Y	Z
a	b	c	d	e	f	g	h	i	j	k	l	m	n	o	p	q	r	s	t	u	v	w	x	y	z













































Handwriting practice lines consisting of 10 sets of three horizontal lines: a solid top line, a dashed middle line, and a solid bottom line.























sat		fit		pin		cot	
mat		pit		tan		cod	
tap		dip		nod		cap	
sap		tip		pan		cat	
pat		sit		pod		can	
map		fin		mop		kit	
pad		dim		top		kid	
dad		fan		dot		cup	
mad		tin		pot		cut	
sad		man		pop		pup	
sip		nap		cop		fun	

	sun		pack		dig		men
	sum		bit		dog		fed
	mud		bat		gum		net
	nut		bad		bug		hog
	sick		bus		big		hug
	duck		bib		pig		ham
	sock		cab		den		hen
	dock		bin		pet		hop
	tack		bud		ten		hot
	muck		bag		bed		hat
	puck		gab		pen		hut

	rag		leg		jog		six
	rot		log		jet		box
	rip		lab		jam		mix
	rat		lock		jug		fix
	rug		lick		job		vet
	rub		wag		jot		van
	ram		wed		yum		quiz
	run		wig		yap		quick
	lip		win		yes		quit
	lid		wet		yam		zip
	led		web		wax		zap
					fox		zag











shed		thud		sick		whiz	
shin		moth		neck		whack	
cash		thin		sack		whip	
fish		bath		tack		wish	
shot		math		chop		wick	
shop		path		chin		well	
bash		thick		chip		pill	
shut		lock		chat		hill	
ship		duck		check		fill	
rash		pack		chick		yell	
dish		rock		rich		bell	











shell		miss		flash		crack	
fell		hiss		glad		brick	
puff		spin		glass		frog	
whiff		twin		slip		drip	
tiff		blob		plug		crib	
buzz		cliff		plum		crab	
huff		blush		sled		brush	
fizz		click		block		truck	
mess		clock		flat		grill	
chess		flush		black		trap	
kiss		floss		dress		grad	









grass		skull	
trash		scan	
drum		skip	
grab		snug	
crash		snag	
drag		step	
drill		stack	
trip		stop	
snap		swish	
snack		swim	
sniff		spill	











tape	
cape	
rake	
gate	
cake	
game	
cave	
mane	
cane	
vase	
lake	











wave	
tame	
gave	
same	
name	
cane	
take	
five	
bite	
hive	
bike	





vine	
pipe	
hide	
nine	
dime	
line	
lime	
dive	
fire	
wipe	
kite	









































like	
pine	
shine	
hose	
nose	
rose	
bone	
home	
joke	
pole	
mole	













































zone	
note	
cone	
lobe	
vote	
poke	
woke	
dome	
tote	
rode	
robe	







































cube	
dune	
cute	
tube	
fuse	
mule	
fume	
mute	
June	
rule	
race	













































mice	
nice	
lace	
page	
cage	
rice	
dice	
sky	
fly	
cry	
spy	













































fry	
dry	
why	
shy	























vest		tent		quilt		hall	
desk		wind		self		wall	
whisk		ramp		raft		tall	
cast		hand		told		fall	
nest		vent		gulp		ball	
fist		golf		lift		roll	
mask		belt		help		bull	
wept		melt		cold		pull	
sand		yolk		fold		doll	
dump		milk		gift		full	
lamp		shelf		call		gull	

fang		rink		tore		fear	
lung		wink		pear		hear	
wing		link		hare		peer	
sing		dunk		bear		star	
ring		pink		share		harp	
hung		boar		chair		bark	
king		soar		fair		barn	
rung		door		car		yarn	
tank		four		cheer		card	
sink		pour		deer		park	
honk		chore		gear		fork	

horn		court		turn		knot	
cork		dirt		hurt		knock	
cord		bird		troll		gnat	
torn		girl		curb		wrap	
fern		stir		lamb		wreck	
thorn		shirt		limb		limb	
corn		whirl		helm			
herd		hurl		next			
perm		surf		film			
perch		curl		knob			
act		burn		knit			

day		show		saw		mail	
ray		tow		oil		laid	
say		low		road		pain	
pay		row		goat		pail	
hay		bow		chew		tail	
tie		mow		rain		rail	
pie		toy		gray		clay	
die		boy		play		foil	
toe		joy		tray		coin	
doe		dew		sail		boil	
hoe		paw		chain		soil	

brow		soap		brew		zoom	
void		fuel		grew		wood	
town		suit		blew		root	
shout		glue		stew		book	
howl		blue		noon		tooth	
couch		haul		flew		hook	
crow		clue		room		cook	
blow		lawn		crew		push	
grow		yawn		moon		foot	
glow		draw		hoop		hood	
snow		claw		boot		look	

heel		bean	
sheep		read	
weed		bead	
feed		moat	
heel		leaf	
peek		load	
leak		meat	
seed		toad	
seat		boat	
beet		loaf	
peach		coat	



This packet is the property of Tara West and is protected through copyright and trademark registrations. All rights reserved.

No part of this digital download may be reproduced electronically, shared without additional licenses, or placed on the internet for others to access without the prior permission from the publisher, Tara West.

If you are a school district using this download as curriculum for more than one teacher an additional school license will need to be purchased.

The clipart images are intellectual property of Laura Strickland of Whimsy Clips.

Contact Information

Email: littlemindsatworkLLC@gmail.com

Website: www.littlemindsatwork.org

Store: <http://www.teacherspayteachers.com/Store/Tara-West>